

Industrial connectivity solutions

Industrial Connectivity Solutions

WARNINGS

The characteristics of the products contained in this catalogue are not binding for Cabur and can be changed, without prior notice, due to production requirements or to improve the products. Hence, please contact our technical-commercial network for any necessary confirmations or updates. You can find additional information about this and other Cabur products at our website www.cabur.eu

The Company

Founded in Italy in 1952, Cabur quickly conquered the role of leader amongst the national manufacturers of terminal blocks for electrical panels, always paying particular attention to the needs of installers and to cutting-edge technological solutions.

Today the company develops and manufactures a wide range of products for the electrotechnical and electronic industry which are renowned for their reliability even in extreme conditions of use.

The current production is the result of the many years of experience gained by Cabur as a partner of the main national bodies and companies, perfected through actions and collaborations abroad and includes:

- Connections for electrical panels
- Automation and control solutions
- Industrial marking systems
- Solutions for renewable energy

The wide and diversified offer guarantees a level of flexibility and unique ability to find solutions tailored to specific needs, which enables us to respond to the most varied and complex installation needs.

Always oriented towards the improvement of its products, in recent years Cabur has responded to the Industry 4.0 project with the expansion of production facilities and important product innovations.

In pursuing a corporate culture based on Total Quality, Cabur has adopted the main European directives of the reference market and collaborates with the most prestigious national and foreign Institutes and Laboratories.

Its products are the result of qualitative choices of particular relevance in the field of raw materials used that, in addition to providing an ample guarantee of functionality and reliability over time, also work in full compliance with all the Norms, Regulations, Laws and applicable requirements, binding and self-adopted, with full satisfaction of all compliance obligations.

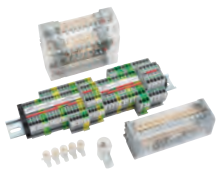

INDUSTRIAL CONNECTIVITY SOLUTIONS



AUTOMATION AND CONTROL SOLUTIONS



INDUSTRIAL MARKING SOLUTIONS



SOLUTIONS FOR RENEWABLE ENERGY



www.cabur.eu

SPRING CLAMP TERMINAL BLOCKS WITH PUSH-IN TECHNOLOGY

FEED-THROUGH AND EARTH TERMINAL BLOCKS.....	13	FUSE-HOLDER TERMINAL BLOCKS.....	23
TWO LEVELS FEED-THROUGH AND EARTH TERMINAL BLOCKS.....	18		
DISCONNECT TERMINAL BLOCKS.....	20		
THREE LEVELS TERMINAL BLOCKS.....	21		
TWO LEVELS DISCONNECT TERMINAL BLOCKS.....	22		

SPRING CLAMP TERMINAL BLOCKS

FEED-THROUGH TERMINAL BLOCKS.....	27	TERMINAL BLOCKS WITH SPECIAL CONNECTIONS.....	47
EARTH TERMINAL BLOCKS.....	33	MINI TERMINAL BLOCKS.....	50
TWO LEVELS TERMINAL BLOCKS.....	37		
THREE LEVELS TERMINAL BLOCKS.....	42		
TERMINAL BLOCKS FOR TEST AND MEASUREMENT.....	44		
FUSE-HOLDER TERMINAL BLOCKS.....	45		

SCREW CLAMP TERMINAL BLOCKS

FEED-THROUGH AND EARTH TERMINAL BLOCKS.....	55	DIODE HOLDER TERMINAL BLOCKS.....	112	MULTI-POLE TERMINAL BLOCKS.....	131
TWO LEVELS TERMINAL BLOCKS.....	90	TERMINAL BLOCKS WITH ELECTRONIC COMPONENTS..	113		
THREE LEVELS TERMINAL BLOCKS.....	95	TERMINAL BLOCKS WITH SPECIAL CONNECTIONS.....	124		
FUSE HOLDER TERMINAL BLOCKS.....	97	TERMINAL BLOCKS FOR THERMOCOUPLES.....	127		
DISCONNECT TERMINAL BLOCKS.....	104	DISCONNECT LEVER TERMINAL BLOCKS.....	128		
FOR TEST AND MEASUREMENT TERMINAL BLOCKS.....	110	MINI TERMINAL BLOCKS.....	129		

DISTRIBUTION TERMINAL BOARDS

MZ DISCONNECT TERMINAL BOARD.....	136	CAMUT 12 POLES TERMINAL STRIPS.....	144.1
QBLOK DISTRIBUTION TERMINAL BOARDS.....	137	FJ FLYING SPRING CONNECTORS.....	144.2
POLM DISTRIBUTION TERMINAL BOARDS.....	142		
CONT TERMINAL BLOCKS.....	143		
CONTC TERMINAL BLOCKS.....	144		

ACCESSORIES

TERMINAL BLOCKS END SECTIONS.....	148	MODULAR TEST PLUGS.....	165	PROTECTION COVERS.....	172
END BRACKETS.....	149	SOCKETS AND PLUGS.....	166	WARNING PLATES.....	173
TAG HOLDER FOR DIN RAIL.....	150	COMPONENT HOLDER.....	167	TAG HOLDER FOR TERMINAL BLOCKS.....	174
MOUNTING RAILS.....	151	SPECIFIC ACCESSORIES.....	168	SCREWDRIVERS.....	175
ACCESSORIES FOR MOUNTING RAILS.....	152	FUSES.....	169	FERRULE.....	176
CROSS CONNECTIONS.....	156	PARTITIONS.....	170		

INDUSTRIAL MARKING SYSTEM (EXTRACT FROM THE CATALOGUE)

SMARTPRINT SYSTEM.....	179
SMARTROLL SYSTEM.....	180
CABURJET SYSTEM.....	181
PRE-PRINTED TAGS FOR CABUR TERMINAL BLOCKS.....	182
PERSONALIZED PRINTING SERVICE.....	184

SPRING-CLAMP TERMINAL BLOCKS WITH PUSH-IN TECHNOLOGY

FEED-THROUGH AND EARTH TERMINAL BLOCKS

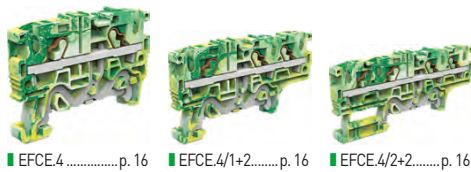
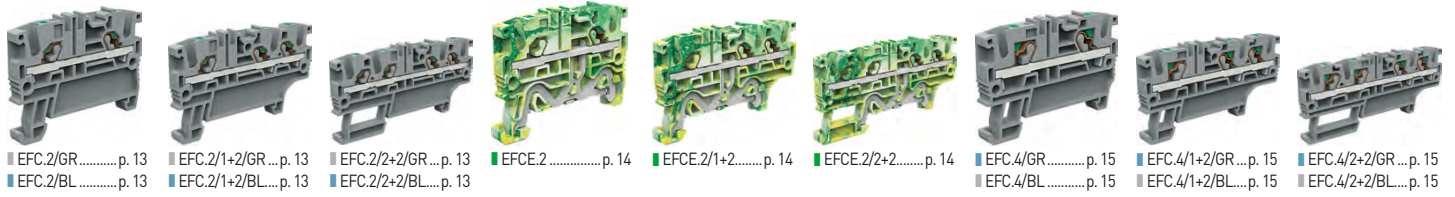

TWO LEVELS FEED-THROUGH AND EARTH TERMINAL BLOCKS

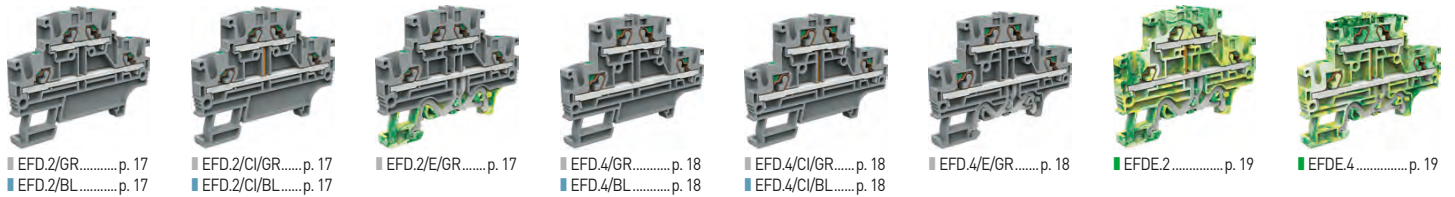

DISCONNECT TERMINAL BLOCKS

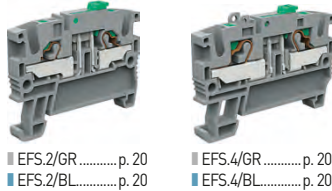

THREE LEVELS TERMINAL BLOCKS

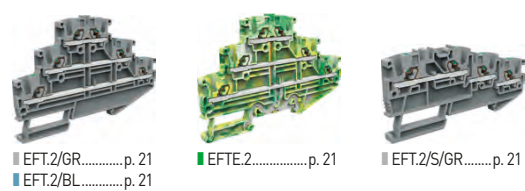

TWO LEVELS DISCONNECT TERMINAL BLOCKS



FUSE HOLDER TERMINAL BLOCKS

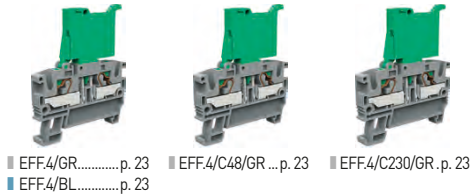

SPRING CLAMP TERMINAL BLOCKS

FEED-THROUGH TERMINAL BLOCKS

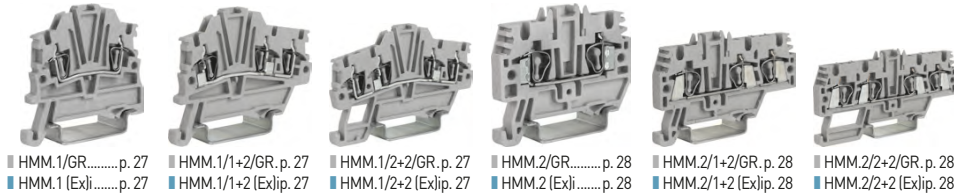

DISCONNECT TERMINAL BLOCKS



FEED-THROUGH TERMINAL BLOCKS

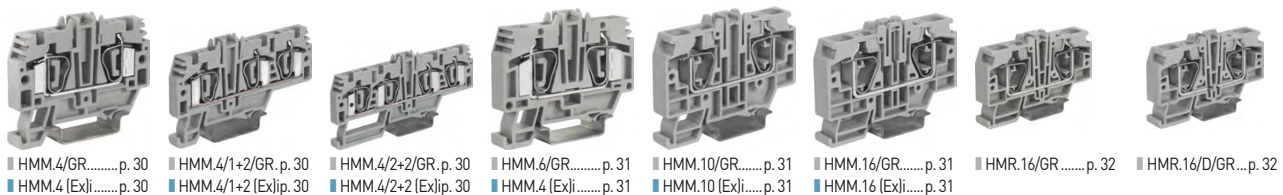

EARTH TERMINAL BLOCKS

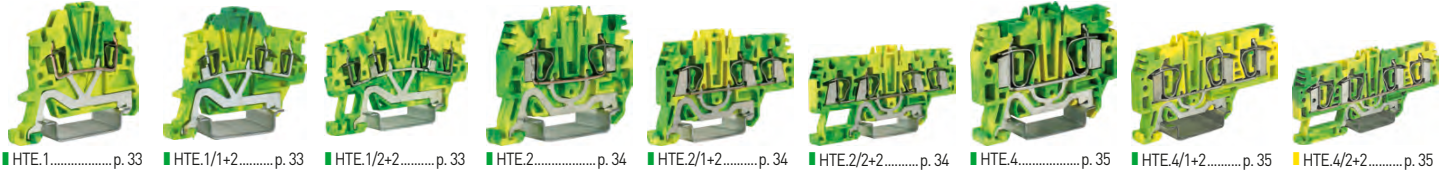

■ HTE.1..... p. 33 ■ HTE.1/1+2..... p. 33 ■ HTE.1/2+2..... p. 33 ■ HTE.2..... p. 34 ■ HTE.2/1+2..... p. 34 ■ HTE.2/2+2..... p. 34 ■ HTE.4..... p. 35 ■ HTE.4/1+2..... p. 35 ■ HTE.4/2+2..... p. 35

EARTH TERMINAL BLOCKS



■ HTE.6..... p. 36 ■ HTE.10..... p. 36 ■ HTE.16..... p. 36

TWO LEVELS TERMINAL BLOCKS



■ HMD.1/GR..... p. 37 ■ HMD.1/CI/GR..... p. 37 ■ HMD.2N/GR..... p. 38 ■ HMD.2N/CI/GR..... p. 38 ■ HMD.2/GR..... p. 39 ■ HMD.1/X/GR..... p. 40
■ HMD.1 [Ex]i..... p. 37 ■ HMD.2N [Ex]i..... p. 38



■ HMD.2N/X/GR..... p. 40 ■ HMD.2N/X1/GR..... p. 40 ■ HMD.2N/DD/GR..... p. 41 ■ HMD.2/3DC/GR..... p. 41

THREE LEVELS TERMINAL BLOCKS



■ HLD.2/GR..... p. 42 ■ HLD.2/CI/GR..... p. 42 ■ HDE.2/GR..... p. 42 ■ HTTE.2..... p. 43
■ HLD.2 [Ex]i..... p. 42

TERMINAL BLOCKS FOR TEST AND MEASUREMENTS



■ HMS.2/GR..... p. 44 ■ HSCB.4/GR..... p. 44 ■ HSCB.6/GR..... p. 44

FUSE-HOLDER TERMINAL BLOCKS



■ HMFA.2/GR..... p. 45 ■ HFR.4/M/GR..... p. 46 ■ HFR.4/GR..... p. 46

TERMINAL BLOCKS FOR CONNECTORS



■ HCD.1/GR..... p. 47 ■ HVPC.2/GR..... p. 48 ■ CHP.2/GR..... p. 48 ■ CHP.2D/GR..... p. 48 ■ HVTE.2..... p. 49 ■ CHTE.2..... p. 49 ■ CHTE.2D..... p. 49
■ HCD.1 [Ex]i..... p. 47 ■ HVPC.2 [Ex]i..... p. 48 ■ CHP.2 [Ex]i..... p. 48 ■ CHP.2D [Ex]i..... p. 48

MINI TERMINAL BLOCKS



■ HPP.2/GR..... p. 50 ■ HP.2/GR..... p. 50 ■ HPC.2/GR..... p. 51
■ HPP.2 [Ex]i..... p. 50 ■ HP.2 [Ex]i..... p. 50 ■ HPC.2 [Ex]i..... p. 51

SCREW CLAMP TERMINAL BLOCKS

FEED-THROUGH TERMINAL BLOCKS - CBC SERIES



■ CBC.2/GR..... p. 55 ■ CBC.4/GR..... p. 55 ■ CBC.6/GR..... p. 55 ■ CBC.10/GR..... p. 56 ■ CBC.16/GR..... p. 56 ■ CBC.35/GR..... p. 56 ■ CBR.2/GR..... p. 57
■ CBC.2 [Ex]i..... p. 55 ■ CBC.4 [Ex]i..... p. 55 ■ CBC.6 [Ex]i..... p. 55 ■ CBC.10 [Ex]i..... p. 56 ■ CBC.16 [Ex]i..... p. 56 ■ CBC.35 [Ex]i..... p. 56 ■ CBR.2 [Ex]i..... p. 57

HIGH CURRENT TERMINAL BLOCKS - GPA SERIES



■ GPA.70/GR..... p. 58 ■ GPA.70/FIX/GR..... p. 58 ■ GPA.95/GR..... p. 59 ■ GPA.95/FIX/GR..... p. 59 ■ GPA.150/GR..... p. 60 ■ GPA.150/FX/GR..... p. 60 ■ GPA.240/GR..... p. 61 ■ GPA.240/FIX/GR..... p. 61
■ GPA.70..... p. 58 ■ GPA.70/FIX..... p. 58 ■ GPA.95..... p. 59 ■ GPA.95/FIX..... p. 59 ■ GPA.150..... p. 60 ■ GPA.150/FIX..... p. 60 ■ GPA.240..... p. 61 ■ GPA.240/FIX..... p. 61
■ GPA.70 [Ex]i..... p. 58 ■ GPA.95 [Ex]i..... p. 59

EARTH TERMINAL BLOCKS



TEC.6/0..... p. 62



TEC.10/0..... p. 62



TEC.16/0..... p. 62



TEC.35/0..... p. 63



TEC.70/0..... p. 63

FEED-THROUGH TERMINAL BLOCKS - CBD SERIES



CBD.2..... p. 67



CBD.4..... p. 67



CBD.6..... p. 67



CBD.10..... p. 68



CBD.16..... p. 68



CBD.35..... p. 68



CBD.50..... p. 69



CBD.70..... p. 69

CBD.2 (ExI)..... p. 67

CBD.4 (ExI)..... p. 67

CBD.6 (ExI)..... p. 67

CBD.10 (ExI)..... p. 68

CBD.16 (ExI)..... p. 68

CBD.35 (ExI)..... p. 68

CBD.50 (ExI)..... p. 69

CBD.70 (ExI)..... p. 69

CBD.50/GR..... p. 69

CBD.70/GR..... p. 69

HIGH CURRENT TERMINAL BLOCKS - GPM SERIES



GPM.95/BB..... p. 71

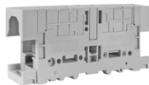

GPM.95/BB/FIX..... p. 71



GPM.150/BB..... p. 72



GPM.150/BB/FIX..... p. 72



GPM.240/BB..... p. 73



GPM.240/BB/FIX..... p. 73



GPM.95/BC..... p. 74



GPM.95/BC/FIX..... p. 74

GPM.95/BB/GR..... p. 71

GPM.95/BB/FIX/GR..... p. 71

GPM.150/BB/GR..... p. 72

GPM.150/BB/FIX/GR..... p. 72

GPM.240/BB/GR..... p. 73

GPM.240/BB/FIX/GR..... p. 73

GPM.95/BC/GR..... p. 74

GPM.95/BC/FIX/GR..... p. 74



GPM.150/BC..... p. 75

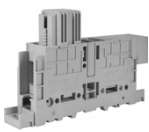

GPM.150/BC/FIX..... p. 75



GPM.240/BC..... p. 76

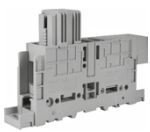

GPM.240/BC/FIX..... p. 76



GPM.95/CC..... p. 77

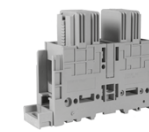

GPM.95/CC/FIX..... p. 77



GPM.150/CC..... p. 78

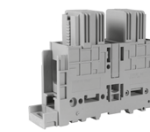

GPM.150/CC/FIX..... p. 78

GPM.150/BC/GR..... p. 75

GPM.150/BC/FIX/GR..... p. 75

GPM.240/BC/GR..... p. 76

GPM.240/BC/FIX/GR..... p. 76

GPM.95/CC/GR..... p. 77

GPM.95/CC/FIX/GR..... p. 77

GPM.150/CC/GR..... p. 78

GPM.150/CC/FIX/GR..... p. 78



GPM.240/CC..... p. 79

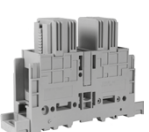

GPM.240/CC/FIX..... p. 79



GPM.95/C/BB..... p. 80



GPM.95/C/BB/FIX..... p. 80



GPM.150/C/BB..... p. 80



GPM.150/C/BB/FIX..... p. 81



GPM.240/C/BB..... p. 81



GPM.240/C/BB/FIX..... p. 81

GPM.240/CC/GR..... p. 79

GPM.240/CC/FIX/GR..... p. 79

GPM.95/O/BB..... p. 80

GPM.95/O/BB/FIX..... p. 80

GPM.150/O/BB..... p. 80

GPM.150/O/BB/FIX..... p. 81

GPM.240/O/BB..... p. 81

GPM.240/O/BB/FIX..... p. 81

HIGH CURRENT TERMINAL BLOCKS ACB SERIES



ACB.70/BB..... p. 82



ACB.120/BB..... p. 82



ACB.185/BB..... p. 82



BCA.70/BB..... p. 83



BCA.120/BB..... p. 83



MBL.50/6..... p. 84



MBL.95/8..... p. 84



MBL.120/10..... p. 85



MBL.150/12..... p. 85

HIGH CURRENT TERMINAL BLOCKS - BCA SERIES

HIGH CURRENT TERMINAL BLOCKS - MBL SERIES

EARTH TERMINAL BLOCKS



TEO.2..... p. 86



CBE.2..... p. 86



TEO.4..... p. 86

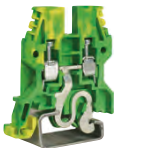

TED.4..... p. 87



TE.6/0..... p. 87



TE.10/0..... p. 87



TE.16/0..... p. 88



TE.50/0..... p. 88

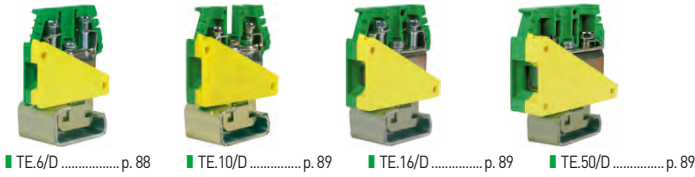

■ TE.6/D p. 88 ■ TE.10/D p. 89 ■ TE.16/D p. 89 ■ TE.50/D p. 89

TWO LEVELS TERMINAL BLOCKS

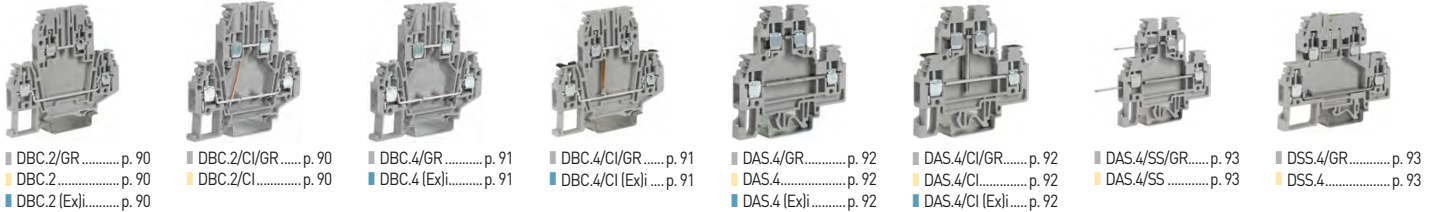

■ DBC.2/GR p. 90 ■ DBC.2/CI/GR p. 90 ■ DBC.4/GR p. 91 ■ DBC.4/CI/GR p. 91 ■ DAS.4/GR p. 92 ■ DAS.4/CI/GR p. 92 ■ DAS.4/SS/GR p. 93 ■ DSS.4/GR p. 93
 ■ DBC.2 p. 90 ■ DBC.2/CI p. 90 ■ DBC.4 (ExI) p. 91 ■ DBC.4/CI (ExI) p. 91 ■ DAS.4 p. 92 ■ DAS.4/CI p. 92 ■ DAS.4/SS p. 93 ■ DSS.4 p. 93
 ■ DBC.2 (ExI) p. 90 ■ DAS.4 (ExI) p. 92 ■ DAS.4/CI (ExI) p. 92

THREE LEVELS TERMINAL BLOCKS

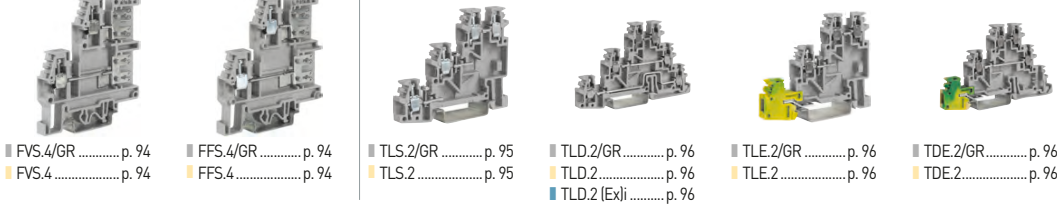

■ FVS.4/GR p. 94 ■ FFS.4/GR p. 94 ■ TLS.2/GR p. 95 ■ TLD.2/GR p. 96 ■ TLE.2/GR p. 96 ■ TDE.2/GR p. 96
 ■ FVS.4 p. 94 ■ FFS.4 p. 94 ■ TLS.2 p. 95 ■ TLD.2 p. 96 ■ TLE.2 p. 96 ■ TDE.2 p. 96
 ■ TLD.2 (ExI) p. 96

FUSE-HOLDER TERMINAL BLOCKS

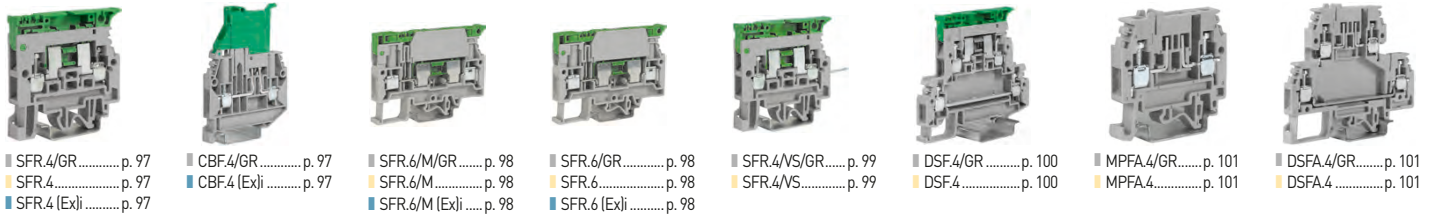

■ SFR.4/GR p. 97 ■ CBF.4/GR p. 97 ■ SFR.6/M/GR p. 98 ■ SFR.6/GR p. 98 ■ SFR.4/VS/GR p. 99 ■ DSF.4/GR p. 100 ■ MPFA.4/GR p. 101 ■ DSFA.4/GR p. 101
 ■ SFR.4 p. 97 ■ CBF.4 (ExI) p. 97 ■ SFR.6/M p. 98 ■ SFR.6 p. 98 ■ SFR.4/VS p. 99 ■ DSF.4 p. 100 ■ MPFA.4 p. 101 ■ DSFA.4 p. 101
 ■ SFR.4 (ExI) p. 97 ■ SFR.6 (ExI) p. 98

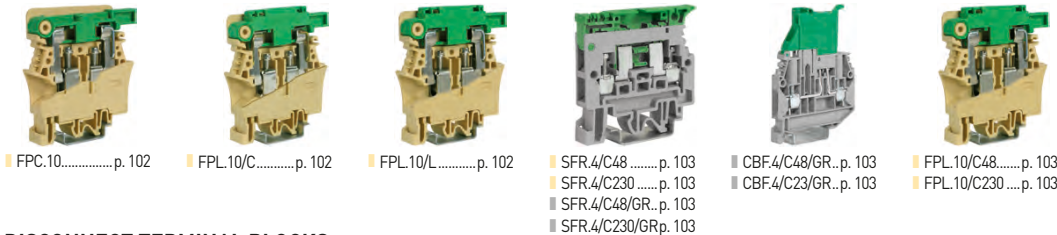

■ FPC.10 p. 102 ■ FPL.10/C p. 102 ■ FPL.10/L p. 102 ■ SFR.4/C48 p. 103 ■ CBF.4/C48/GR p. 103 ■ FPL.10/C48 p. 103
 ■ SFR.4/C230 p. 103 ■ CBF.4/C23/GR p. 103 ■ FPL.10/C230 p. 103
 ■ SFR.4/C48/GR p. 103 ■ SFR.4/C230/GR p. 103

DISCONNECT TERMINAL BLOCKS

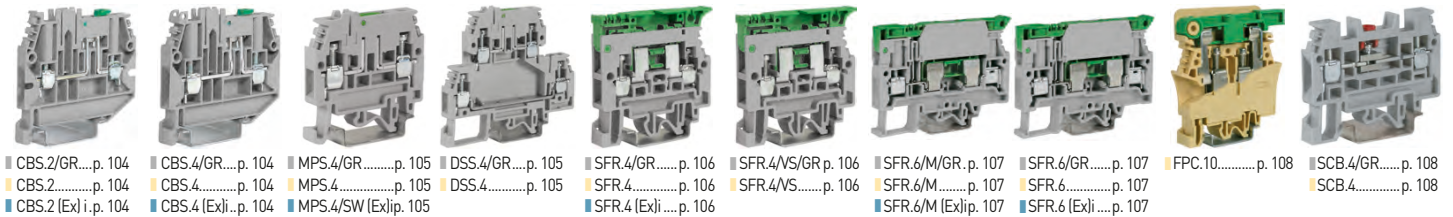

■ CBS.2/GR p. 104 ■ CBS.4/GR p. 104 ■ MPS.4/GR p. 105 ■ DSS.4/GR p. 105 ■ SFR.4/GR p. 106 ■ SFR.4/VS/GR p. 106 ■ SFR.6/M/GR p. 107 ■ SFR.6/GR p. 107 ■ FPC.10 p. 108 ■ SCB.4/GR p. 108
 ■ CBS.2 p. 104 ■ CBS.4 p. 104 ■ MPS.4 p. 105 ■ DSS.4 p. 105 ■ SFR.4 p. 106 ■ SFR.4/VS p. 106 ■ SFR.6/M p. 107 ■ SFR.6 p. 107 ■ SCB.4 p. 108
 ■ CBS.2 (ExI) p. 104 ■ CBS.4 (ExI) p. 104 ■ MPS.4/SW (ExI) p. 105 ■ SFR.4 (ExI) p. 106 ■ SFR.6 (ExI) p. 107

DISCONNECT TERMINAL BLOCKS

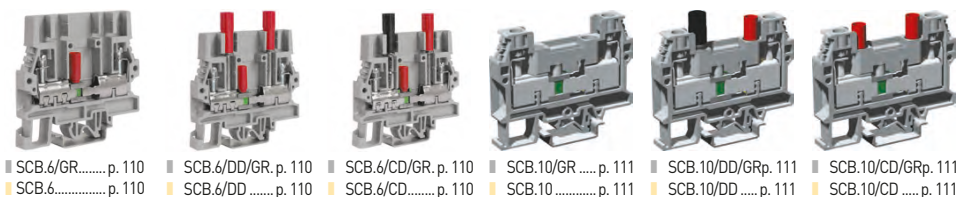

■ SCB.6/GR p. 110 ■ SCB.6/DD/GR p. 110 ■ SCB.6/CD/GR p. 110 ■ SCB.10/GR p. 111 ■ SCB.10/DD/GR p. 111 ■ SCB.10/CD/GR p. 111
 ■ SCB.6 p. 110 ■ SCB.6/DD p. 110 ■ SCB.6/CD p. 110 ■ SCB.10 p. 111 ■ SCB.10/DD p. 111 ■ SCB.10/CD p. 111

DIODE-HOLDER TERMINAL BLOCKS

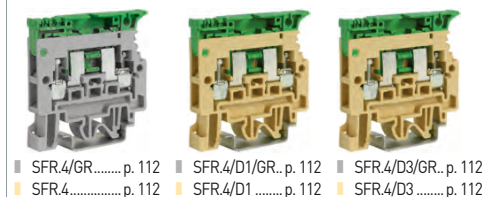

■ SFR.4/GR p. 112 ■ SFR.4/D1/GR p. 112 ■ SFR.4/D3/GR p. 112
 ■ SFR.4 p. 112 ■ SFR.4/D1 p. 112 ■ SFR.4/D3 p. 112

TERMINAL BLOCKS WITH ELECTRONIC COMPONENTS



- DAS.4/D5/GR...p. 114
- DAS.4/D12/GR p. 114
- DAS.4/D24/GR p. 115
- DAS.4/D60/GR p. 115
- DAS.4/V24/GR.p. 116
- DAS.4/V48/GR.p. 116
- DAS.4/V120/GRp. 117
- DAS.4/V230/GRp. 117
- DAS.4/A/GR.....p. 118
- DAS.4/D5.....p. 114
- DAS.4/D12.....p. 114
- DAS.4/D24.....p. 115
- DAS.4/D60.....p. 115
- DAS.4/V24.....p. 116
- DAS.4/V48.....p. 116
- DAS.4/V120.....p. 117
- DAS.4/V230.....p. 117
- DAS.4/A.....p. 118



- DAS.4/B/GR.....p. 118
- DAS.4/C/GR.....p. 119
- DAS.4/D/GR.....p. 119
- DAS.4/E/GR.....p. 120
- DAS.4/I/GR.....p. 120
- DAS.4/L/GR.....p. 121
- DAS.4/DD/GR.....p. 121
- DAS.4/T/GR.....p. 122
- DAS.4/U/GR.....p. 122
- DAS.4/B.....p. 118
- DAS.4/C.....p. 119
- DAS.4/D.....p. 119
- DAS.4/E.....p. 120
- DAS.4/I.....p. 120
- DAS.4/L.....p. 121
- DAS.4/DD.....p. 121
- DAS.4/T.....p. 122
- DAS.4/U.....p. 122

TERMINAL BLOCKS WITH SPECIAL CONNECTIONS AND FOR CONNECTORS



- AFO.2/1+1.....p. 123
- AFO.2/2+2.....p. 123
- PDF.2/GR.....p. 124
- FDP.2/GR.....p. 124
- CVF.4/GR.....p. 124
- VPC.2/GR.....p. 125
- VPD.2/GR.....p. 126
- TC/PO.....p. 127
- MAC.6.....p. 128
- CAM.....p. 128
- PDF.2.....p. 124
- FDP.2.....p. 124
- CVF.4.....p. 124
- VPC.2 [Ex]i.....p. 125
- VPD.2 [Ex]i.....p. 126
- TC/PO/GR.....p. 127
- TC/PO [Ex]i.....p. 127

MINI TERMINAL BLOCKS



- RN.1/GR.....p. 129
- RN.2/GR.....p. 129
- RP.4/GR.....p. 129
- TR.2.....p. 130
- TR.4.....p. 130
- RN.1 [Ex]i.....p. 129
- RN.2 [Ex]i.....p. 129
- RP.4 [Ex]i.....p. 129

MODULAR MULTI POLE TERMINAL BLOCKS



- BPL.4.....p. 131
- TPL.4.....p. 131
- BPL/R.....p. 131
- BPL.4/PS.....p. 132
- TPL.4/PS.....p. 132
- CF.12/1+1.....p. 133
- CF.12/2+2.....p. 133
- CF.12/CPT.....p. 133

DISTRIBUTION TERMINAL BOARDS



- QBLOK.....p. 137-142



- CONTC - CONT - CAMUT - FJ.....p.143-144.2

ACCESSORIES.....p. 145



Spring-Clamp Terminal Blocks with Push-In Technology

Cabur EFC:
Easy Fast Connection

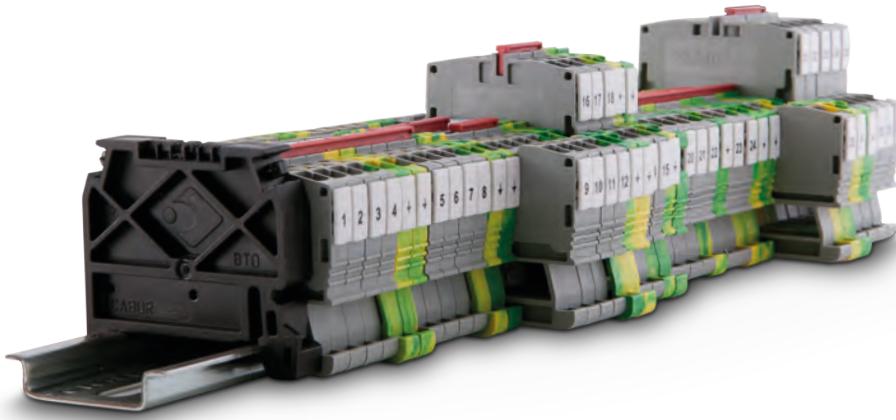

IMQ 18 ATEX 007U	IECEX IMQ 18.0002U
I M2 Ex eb I Mb	Ex eb I Mb
II 2 G Ex eb IIC Gb	Ex eb IIC Gb

The new line of EFC products with Push-in connection technology offers a fast, reliable and efficient wiring of all cable types.

REDUCTION OF INSTALLATION TIME, INCREASED PERFORMANCE

The Push-in technology allows cables and hoses to be wired with or without wire clips. Cables are directly inserted in the terminal, with no tooling required to open the clamp spring: just pressing the wire is sufficient to provide a safe and durable electrical connection.

DIRECT PLUG-IN

Connection is so simple, precise and accurate that a switchboard can be wired with a single hand, without impacting performance. This also improves ergonomics. To connect stiff cables without a wire clip, just push the coloured button to open the spring clip and insert the properly stripped cable.

WIRE RELEASE BUTTONS: SPEED, SIMPLICITY AND SAFETY

To remove the wire from the terminal, just press the release button with any tool to open the spring. Release buttons, highlighted by different colours, prevent operators from making mistakes or coming into contact with potentially live parts, even in settings with a high concentration of links.



Speed

The Push-in technology helps reducing wiring times up to 75%.



Safety

An isolated button, identified with a different colour, protects the operator from indirect electrical contacts.



Quality

Having passed all the ATEX Directives, UL and EN60947-7 standards tests, these devices are suitable for any use and environment.



Simplicity

The stainless-steel spring designed by Cabur ensures optimal connection and prevents accidental removal.



Innovation

A compact and highly-visible design optimizes space in automation and control boards.



Efficiency

At last, one single hand is enough to wire an EFC series clamp, for a smoother workflow.

EFC.2 SERIES

SPRING CLAMP TERMINAL BLOCKS WITH PUSH-IN TECHNOLOGY



- Reduced wiring time
- Wire release button



IMQ 18 ATEX 007U
I M2 Ex eb I Mb
II 2G Ex eb IIC Gb

IECEX IMQ 18.0002U
Ex eb I Mb
Ex eb IIC Gb

[1] See chapter accessories for more details



GREY VERSION	CODE	EFC200GR	EFC.2/GR	EFC210GR	EFC.2/1+2/GR	EFC220GR	EFC.2/2+2/GR
	TYPE	EFC200BL	EFC.2/BL	EFC210BL	EFC.2/1+2/BL	EFC220BL	EFC.2/2+2/BL

TECHNICAL CHARACTERISTICS

Function/type		Feed-through	Feed-through	Feed-through
Rated cross-section	(mm ²)	2.5	2.5	2.5
Connecting capacity	Flexible (mm ²)	0,2 ÷ 4	0,2 ÷ 4	0,2 ÷ 4
	Rigid (mm ²)	0,2 ÷ 4	0,2 ÷ 4	0,2 ÷ 4
	Max.flexible with ferrule - ferrule type (mm ²)	2,5 - WP25/19	2,5 - WP25/19	2,5 - WP25/19
Electrical characteristics According to European standard IEC EN 60947-7-1	Max AC/DC Voltage (V)	800	800	800
	Max current with rated cross-section (A)	24	24	24
	Section Caliber	A3	A3	A3
Electrical characteristics According to UL	Max AC/DC Voltage (V)	600	600	600
	Max current with rated cross-section (A)	20	20	20
	Section Min-Max (AWG)	24 - 12	24 - 12	24 - 12
Electrical characteristics According to ATEX directive and IEC ex standard	Max AC/DC Voltage (V)	500	500	500
	Max current with rated cross-section (A)	20	20	20
	Operating temperature (°C)	-40 +110	-40 +110	-40 +110
Rated impulse withstand voltage/pollution degree		6kV / 3	6kV / 3	6kV / 3
Insulation stripping length (mm)		9	9	9
Width (mm)		5.2	5.2	5.2
Length (mm)		49.6	63.1	76.6
Height mounted on TH35/7,5 (mm)		39.2	39.2	39.2
Height mounted on TH35/15 (mm)		46.7	46.7	46.7
Insulation material temperature index (EN 60216-1) (°C)		130	130	130
Plastic material		polyamide UL94V-0	polyamide UL94V-0	polyamide UL94V-0

APPROVALS

ACCESSORIES				
End section	Grey	EFC.2/PT/GR (cod. EFC201GR)	EFC.2/1+2/PT/GR (cod. EFC211GR)	EFC.2/2+2/PT/GR (cod. EFC221GR)
	Blue	EFC.2/PT/BL (cod. EFC201BL)	EFC.2/1+2/PT/BL (cod. EFC211BL)	EFC.2/2+2/PT/BL (cod. EFC221BL)
	Thickness (mm)	1.5	1.5	1.5
Cross connection	(1)	EFB.2/.../... (cod. EFB02...)	EFB.2/.../... (cod. EFB02...)	EFB.2/.../... (cod. EFB02...)
	Rated current / Rated current ATEX applications (A)	24 / 20	24 / 20	24 / 20
Coloured partition	red	DFE.1+1/R (cod. DFE01R)	DFE.1+2/R (cod. DFE02R)	DFE.2+2/R (cod. DFE03R)
105mm adhesive numbering strip		TMM102105AW (cod. TMM102105AW)	TMM102105AW (cod. TMM102105AW)	TMM102105AW (cod. TMM102105AW)
105mm snap numbering strip		TMM102105W (cod. TMM102105W)	TMM102105W (cod. TMM102105W)	TMM102105W (cod. TMM102105W)
Single marking tag		CNU/10/51 (cod. NU1051S)	CNU/10/51 (cod. NU1051S)	CNU/10/51 (cod. NU1051S)
Single marking tag for pitch insert		CNU/10/51 (cod. NU1051S)	CNU/10/51 (cod. NU1051S)	CNU/10/51 (cod. NU1051S)
End bracket	Screw TH35	BT/3 (cod. BT003)	BT/3 (cod. BT003)	BT/3 (cod. BT003)
	Snap-fit TH35	BTO (cod. BT007)	BTO (cod. BT007)	BTO (cod. BT007)

- Reduced wiring time
- Wire release button

	IMQ 18 ATEX 007U	IECEX IMQ 18.0002U
	I M2 Ex eb I Mb	Ex eb I Mb
	II 2G Ex eb IIC Gb	Ex eb IIC Gb

(1) See chapter accessories for more details



YELLOW/GREEN VERSION	CODE TYPE	EFCE200	EFCE210	EFCE220
----------------------	-----------	---------	---------	---------

TECHNICAL CHARACTERISTICS		EFCE.2	EFCE.2/1+2	EFCE.2/2+2
Function/type		Earth terminal blocks	Earth terminal blocks	Earth terminal blocks
Rated cross-section	(mm ²)	2,5	2,5	2,5
Connecting capacity	Flexible (mm ²)	0,2 ÷ 4	0,2 ÷ 4	0,2 ÷ 4
	Rigid (mm ²)	0,2 ÷ 4	0,2 ÷ 4	0,2 ÷ 4
	Max.flexible with ferrule - ferrule type (mm ²)	2,5 - WP25/19	2,5 - WP25/19	2,5 - WP25/19
Electrical characteristics According to European standard IEC EN 60947-7-2	Max AC/DC Voltage (V)	-	-	-
	Max current with rated cross-section (A)	-	-	-
	Section Caliber	A3	A3	A3
Electrical characteristics According to UL	Max AC/DC Voltage (V)	-	-	-
	Max current with rated cross-section (A)	-	-	-
	Section Min-Max (AWG)	24 - 12	24 - 12	24 - 12
Electrical characteristics According to ATEX directive and IEC ex standard	Max AC/DC Voltage (V)	-	-	-
	Max current with rated cross-section (A)	20	20	20
	Operating temperature (°C)	-40 +110	-40 +110	-40 +110
Rated impulse withstand voltage/pollution degree		6kV / 3	6kV / 3	6kV / 3
Insulation stripping length (mm)		9	9	9
Width (mm)		5.2	5.2	5.2
Length (mm)		51.1	64.6	78.1
Height mounted on TH35/7,5 (mm)		39.2	39.2	39.2
Height mounted on TH35/15 (mm)		46.7	46.7	46.7
Insulation material temperature index (EN 60216-1) (°C)		130	130	130
Plastic material		polyamide UL94V-0	polyamide UL94V-0	polyamide UL94V-0

APPROVALS



ACCESSORIES				
End section	Grey	EFC.2/PT/GR (cod. EFC201GR)	EFC.2/1+2/PT/GR (cod. EFC211GR)	EFC.2/2+2/PT/GR (cod. EFC221GR)
	Blue	EFC.2/PT/BL (cod. EFC201BL)	EFC.2/1+2/PT/BL (cod. EFC211BL)	EFC.2/2+2/PT/BL (cod. EFC221BL)
Cross connection	Thickness (mm)	1.5	1.5	1.5
	{1}	EFB.2/.../... (cod. EFB02...)	EFB.2/.../... (cod. EFB02...)	EFB.2/.../... (cod. EFB02...)
Coloured partition	Rated current / Rated current ATEX applications (A)	24 / 20	24 / 20	24 / 20
	red	DFE.1+1/R (cod. DFE01R)	DFE.1+2/R (cod. DFE02R)	DFE.2+2/R (cod. DFE03R)
105mm adhesive numbering strip		TMM102105AW (cod. TMM102105AW)	TMM102105AW (cod. TMM102105AW)	TMM102105AW (cod. TMM102105AW)
105mm snap numbering strip		TMM102105W (cod. TMM102105W)	TMM102105W (cod. TMM102105W)	TMM102105W (cod. TMM102105W)
Single marking tag		CNU/10/51 (cod. NU1051S)	CNU/10/51 (cod. NU1051S)	CNU/10/51 (cod. NU1051S)
Single marking tag for pitch insert		CNU/10/51 (cod. NU1051S)	CNU/10/51 (cod. NU1051S)	CNU/10/51 (cod. NU1051S)
End bracket	Screw TH35	BT/3 (cod. BT003)	BT/3 (cod. BT003)	BT/3 (cod. BT003)
	Snap-fit TH35	BTO (cod. BT007)	BTO (cod. BT007)	BTO (cod. BT007)

EFC.4 SERIES

SPRING CLAMP TERMINAL BLOCKS WITH PUSH-IN TECHNOLOGY



- Reduced wiring time
- Wire release button



IMQ 18 ATEX 007U
I M2 Ex eb I Mb
II 2G Ex eb IIC Gb

IECEX IMQ 18.0002U
Ex eb I Mb
Ex eb IIC Gb

[1] See chapter accessories for more details



GREY VERSION	CODE	EFC400GR	EFC410GR	EFC420GR
	TYPE	EFC.4/GR	EFC.4/1+2/GR	EFC.4/2+2/GR
BLUE VERSION	CODE	EFC400BL	EFC410BL	EFC420BL
	TYPE	EFC.4/BL	EFC.4/1+2/BL	EFC.4/2+2/BL

TECHNICAL CHARACTERISTICS

Function/type		Feed-through	Feed-through	Feed-through
Rated cross-section	(mm ²)	4	4	4
Connecting capacity	Flexible (mm ²)	0,2 ÷ 6	0,2 ÷ 6	0,2 ÷ 6
	Rigid (mm ²)	0,2 ÷ 6	0,2 ÷ 6	0,2 ÷ 6
	Max.flexible with ferrule - ferrule type (mm ²)	4 - WP40/16	4 - WP40/16	4 - WP40/16
Electrical characteristics According to European standard IEC EN 60947-7-1	Max AC/DC Voltage (V)	800	800	800
	Max current with rated cross-section (A)	32	32	32
	Section Caliber	A4	A4	A4
Electrical characteristics According to UL	Max AC/DC Voltage (V)	600	600	600
	Max current with rated cross-section (A)	30	30	30
	Section Min-Max (AWG)	24 - 12	24 - 12	24 - 12
Electrical characteristics According to ATEX directive and IEC ex standard	Max AC/DC Voltage (V)	500	500	500
	Max current with rated cross-section (A)	26	26	26
	Operating temperature (°C)	-40 +110	-40 +110	-40 +110
Rated impulse withstand voltage/pollution degree		6kV / 3	6kV / 3	6kV / 3
Insulation stripping length (mm)		10	10	10
Width (mm)		6.2	6.2	6.2
Length (mm)		55.2	71.8	88.4
Height mounted on TH35/7,5 (mm)		39.2	39.2	39.2
Height mounted on TH35/15 (mm)		46.7	46.7	46.7
Insulation material temperature index (EN 60216-1) (°C)		130	130	130
Plastic material		polyamide UL94V-0	polyamide UL94V-0	polyamide UL94V-0

APPROVALS

ACCESSORIES

End section	Grey	EFC.4/PT/GR (cod. EFC401GR)	EFC.4/1+2/PT/GR (cod. EFC411GR)	EFC.4/2+2/PT/GR (cod. EFC421GR)
	Blue	EFC.4/PT/BL (cod. EFC401BL)	EFC.4/1+2/PT/BL (cod. EFC411BL)	EFC.4/2+2/PT/BL (cod. EFC421BL)
	Thickness (mm)	1,5	1,5	1,5
Cross connection	(1)	EFB.4/.../... (cod. EFB04...)	EFB.4/.../... (cod. EFB04...)	EFB.4/.../... (cod. EFB04...)
	Rated current / Rated current ATEX applications (A)	32 / 26	32 / 26	32 / 26
Coloured partition	red	DfE.1+1/R (cod. DfE01R)	DfE.1+2/R (cod. DfE02R)	DfE.2+2/R (cod. DfE03R)
105mm adhesive numbering strip		TMM102105AW (cod. TMM102105AW)	TMM102105AW (cod. TMM102105AW)	TMM102105AW (cod. TMM102105AW)
105mm snap numbering strip		TMM102105W (cod. TMM102105W)	TMM102105W (cod. TMM102105W)	TMM102105W (cod. TMM102105W)
Single marking tag		CNU/10/51 (cod. NU1051S)	CNU/10/51 (cod. NU1051S)	CNU/10/51 (cod. NU1051S)
Single marking tag for pitch insert		CNU/10/51 (cod. NU1051S)	CNU/10/51 (cod. NU1051S)	CNU/10/51 (cod. NU1051S)
End bracket	Screw TH35	BT/3 (cod. BT003)	BT/3 (cod. BT003)	BT/3 (cod. BT003)
	Snap-fit TH35	BTO (cod. BT007)	BTO (cod. BT007)	BTO (cod. BT007)

- Reduced wiring time
- Wire release button

	IMQ 18 ATEX 007U	IECEX IMQ 18.0002U
	I M2 Ex eb I Mb	Ex eb I Mb
	II 2G Ex eb IIC Gb	Ex eb IIC Gb

(1) See chapter accessories for more details



GREY VERSION	CODE	EFCE400	EFCE410	EFCE420
	TYPE	EFCE.4	EFCE.4/1+2	EFCE.4/2+2

TECHNICAL CHARACTERISTICS

Function/type		Earth terminal blocks	Earth terminal blocks	Earth terminal blocks
Rated cross-section	(mm ²)	4	4	4
Connecting capacity	Flexible (mm ²)	0,2 ÷ 6	0,2 ÷ 6	0,2 ÷ 6
	Rigid (mm ²)	0,2 ÷ 6	0,2 ÷ 6	0,2 ÷ 6
	Max.flexible with ferrule - ferrule type (mm ²)	4 - WP40/16	4 - WP40/16	4 - WP40/16
Electrical characteristics According to European standard IEC EN 60947-7-1	Max AC/DC Voltage (V)	-	-	-
	Max current with rated cross-section (A)	-	-	-
	Section Caliber	A4	A4	A4
Electrical characteristics According to UL	Max AC/DC Voltage (V)	-	-	-
	Max current with rated cross-section (A)	-	-	-
	Section Min-Max (AWG)	24 - 10	24 - 10	24 - 10
Electrical characteristics According to ATEX directive and IEC ex standard	Max AC/DC Voltage (V)	-	-	-
	Max current with rated cross-section (A)	26	26	26
	Operating temperature (°C)	-40 +110	-40 +110	-40 +110
Rated impulse withstand voltage/pollution degree		6kV / 3	6kV / 3	6kV / 3
Insulation stripping length (mm)		10	10	10
Width (mm)		6.2	6.2	6.2
Length (mm)		55.2	71.8	88.4
Height mounted on TH35/7,5 (mm)		39.2	39.2	39.2
Height mounted on TH35/15 (mm)		46.7	46.7	46.7
Insulation material temperature index (EN 60216-1) (°C)		130	130	130
Plastic material		polyamide UL94V-0	polyamide UL94V-0	polyamide UL94V-0

APPROVALS

ACCESSORIES

End section	Grey	EFC.4/PT/GR (cod. EFC401GR)	EFC.4/1+2/PT/GR (cod. EFC411GR)	EFC.4/2+2/PT/GR (cod. EFC421GR)
	Blue	EFC.4/PT/BL (cod. EFC401BL)	EFC.4/1+2/PT/BL (cod. EFC411BL)	EFC.4/2+2/PT/BL (cod. EFC421BL)
Cross connection	Thickness (mm)	1.5	1.5	1.5
	(1)	EFB.4/.../... (cod. EFB04...)	EFB.4/.../... (cod. EFB04...)	EFB.4/.../... (cod. EFB04...)
Coloured partition	Rated current / Rated current ATEX applications (A)	32 / 26	32 / 26	32 / 26
	red	DFE.1+1/R (cod. DFE01R)	DFE.1+2/R (cod. DFE02R)	DFE.2+2/R (cod. DFE03R)
105mm adhesive numbering strip		TMM102105AW (cod. TMM102105AW)	TMM102105AW (cod. TMM102105AW)	TMM102105AW (cod. TMM102105AW)
105mm snap numbering strip		TMM102105W (cod. TMM102105W)	TMM102105W (cod. TMM102105W)	TMM102105W (cod. TMM102105W)
Single marking tag		CNU/10/51 (cod. NU1051S)	CNU/10/51 (cod. NU1051S)	CNU/10/51 (cod. NU1051S)
Single marking tag for pitch insert		CNU/10/51 (cod. NU1051S)	CNU/10/51 (cod. NU1051S)	CNU/10/51 (cod. NU1051S)
End bracket	Screw TH35	BT/3 (cod. BT003)	BT/3 (cod. BT003)	BT/3 (cod. BT003)
	Snap-fit TH35	BTO (cod. BT007)	BTO (cod. BT007)	BTO (cod. BT007)

EFD.2 SERIES

SPRING CLAMP TERMINAL BLOCKS WITH 2 LEVELS AND PUSH-IN TECHNOLOGY



- Reduced wiring time
- Wire release button

	IMQ 18 ATEX 007U	IECEX IMQ 18.0002U
	I M2 Ex eb I Mb	Ex eb I Mb
	II 2G Ex eb IIC Gb	Ex eb IIC Gb

(1) See chapter accessories for more details

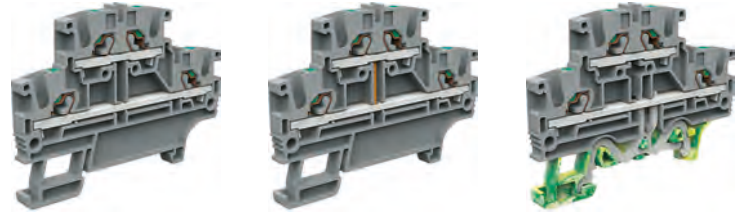

GREY VERSION	CODE	EFD200GR	EFD.2/GR	EFD210GR	EFD.2/CI/GR	EFD220GR	EFD.2/E/GR
	TYPE						
BLUE VERSION	CODE	EFD200BL		EFD210BL			
	TYPE		EFD.2/BL		EFD.2/CI/BL		

TECHNICAL CHARACTERISTICS

Function/type		2 levels	2 levels and internal connection	2 feed-through levels + earth	
Rated cross-section	(mm ²)	2.5	2.5	2.5	
Connecting capacity	Flexible	0,2 ÷ 4	0,2 ÷ 4	0,2 ÷ 4	
	Rigid	0,2 ÷ 4	0,2 ÷ 4	0,2 ÷ 4	
	Max.flexible with ferrule - ferrule type	(mm ²)	2,5 - WP25/19	2,5 - WP25/19	2,5 - WP25/19
Electrical characteristics According to European standard IEC EN 60947-7-1	Max AC/DC Voltage	(V)	800	800	800
	Max current with rated cross-section	(A)	22	22	22
	Section	Caliber	A3	A3	A3
Electrical characteristics According to UL	Max AC/DC Voltage	(V)	600	600	600
	Max current with rated cross-section	(A)	20	20	20
	Section Min-Max	(AWG)	24-12	24-12	24-12
Electrical characteristics According to ATEX directive and IEC ex standard	Max AC/DC Voltage	(V)	500	500	500
	Max current with rated cross-section	(A)	18	18	18
	Operating temperature	(°C)	-40 +110	-40 +110	-40 +110
Rated impulse withstand voltage/pollution degree		6kV / 3	6kV / 3	6kV / 3	
Insulation stripping length	(mm)	9	9	9	
Width	(mm)	5.2	5.2	5.2	
Length	(mm)	71.6	71.6	71.6	
Height mounted on TH35/7,5	(mm)	53.8	53.8	53.8	
Height mounted on TH35/15	(mm)	61.3	61.3	61.3	
Insulation material temperature index (EN 60216-1)	(°C)	130	130	130	
Plastic material		polyamide UL94V-0	polyamide UL94V-0	polyamide UL94V-0	

APPROVALS

ACCESSORIES

End section		EFD.2/PT/GR (cod. EFD201GR)	EFD.2/PT/GR (cod. EFD201GR)	EFD.2/PT/GR (cod. EFD201GR)
	Grey			
	Blue	EFD.2/PT/BL (cod. EFD201BL)	EFD.2/PT/BL (cod. EFD201BL)	EFD.2/PT/BL (cod. EFD201BL)
	Thickness	(mm)	1.5	1.5
Cross connection	(1)	EFB.2/.../... (cod. EFB02...)	EFB.2/.../... (cod. EFB02...)	EFB.2/.../... (cod. EFB02...)
	Rated current / Rated current ATEX applications	(A)	22 / 18	22 / 18
Coloured partition	red	DFE.2P/R (cod. DFE04R)	DFE.2P/R (cod. DFE04R)	DFE.2P/R (cod. DFE04R)
105mm adhesive numbering strip		-	-	-
105mm snap numbering strip		-	-	-
Single marking tag		CNU/10/51 (cod. NU1051S)	CNU/10/51 (cod. NU1051S)	CNU/10/51 (cod. NU1051S)
Single marking tag for pitch insert		CNU/10/51 (cod. NU1051S)	CNU/10/51 (cod. NU1051S)	CNU/10/51 (cod. NU1051S)
End bracket	Screw TH35	BT/3 (cod. BT003)	BT/3 (cod. BT003)	BT/3 (cod. BT003)
	Snap-fit TH35	BTO (cod. BT007)	BTO (cod. BT007)	BTO (cod. BT007)



EFD.4 SERIES

SPRING CLAMP TERMINAL BLOCKS WITH 2 LEVELS AND PUSH-IN TECHNOLOGY



- Reduced wiring time
- Wire release button

	IMQ 18 ATEX 007U	IECEX IMQ 18.0002U
	I M2 Ex eb I Mb	Ex eb I Mb
	II 2G Ex eb IIC Gb	Ex eb IIC Gb

(1) See chapter accessories for more details

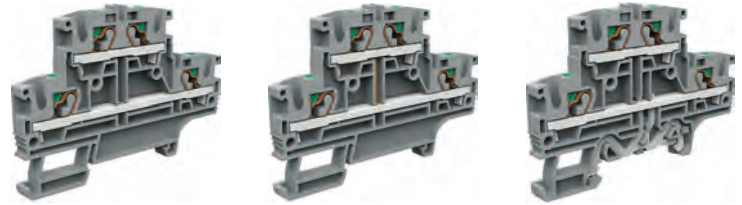

GREY VERSION	CODE	EFD400GR	EFD410GR	EFD420GR
	TYPE	EFD.4/GR	EFD.4/CI/GR	EFD.4/E/GR
BLUE VERSION	CODE	EFD400BL	EFD410BL	
	TYPE	EFD.4/BL	EFD.4/CI/BL	

TECHNICAL CHARACTERISTICS

Function/type		2 levels	2 levels and internal connection	2 levels (Feed-through + terra)
Rated cross-section	(mm ²)	4	4	4
Connecting capacity	Flexible	0,2 ÷ 6	0,2 ÷ 6	0,2 ÷ 6
	Rigid	0,2 ÷ 6	0,2 ÷ 6	0,2 ÷ 6
	Max.flexible with ferrule - ferrule type	4 - WP40/16	4 - WP40/16	4 - WP40/16
Electrical characteristics According to European standard IEC EN 60947-7-1	Max AC/DC Voltage	800	800	800
	Max current with rated cross-section	29	29	29
	Section	Caliber A4	A4	A4
Electrical characteristics According to UL	Max AC/DC Voltage	600	600	600
	Max current with rated cross-section	30	30	30
	Section Min-Max	24-10	24-10	24-10
Electrical characteristics According to ATEX directive and IEC ex standard	Max AC/DC Voltage	500	500	500
	Max current with rated cross-section	25	25	25
	Operating temperature	-40 +110	-40 +110	-40 +110
Rated impulse withstand voltage/pollution degree		6kV / 3	6kV / 3	6kV / 3
Insulation stripping length	(mm)	10	10	10
Width	(mm)	6.2	6.2	6.2
Length	(mm)	81.7	81.7	81.7
Height mounted on TH35/7,5	(mm)	57.7	57.7	57.7
Height mounted on TH35/15	(mm)	65.2	65.2	65.2
Insulation material temperature index (EN 60216-1)	(°C)	130	130	130
Plastic material		polyamide UL94V-0	polyamide UL94V-0	polyamide UL94V-0

APPROVALS

ACCESSORIES		EFD400GR	EFD410GR	EFD420GR
End section	Grey	EFD.4/PT/GR (cod. EFD401GR)	EFD.4/PT/GR (cod. EFD401GR)	EFD.4/PT/GR (cod. EFD401GR)
	Blue	EFD.4/PT/BL (cod. EFD401BL)	EFD.4/PT/BL (cod. EFD401BL)	EFD.4/PT/BL (cod. EFD401BL)
	Thickness	(mm) 1,5	1,5	1,5
Cross connection	(1)	EFB.4/.../... (cod. EFB04...)	EFB.4/.../... (cod. EFB04...)	EFB.4/.../... (cod. EFB04...)
	Rated current / Rated current ATEX applications	(A) 29 / 25	29 / 25	29 / 25
Coloured partition	red	DFE.2P/R (cod. DFE04R)	DFE.2P/R (cod. DFE04R)	DFE.2P/R (cod. DFE04R)
105mm adhesive numbering strip		-	-	-
105mm snap numbering strip		-	-	-
Single marking tag		CNU/10/51 (cod. NU1051S)	CNU/10/51 (cod. NU1051S)	CNU/10/51 (cod. NU1051S)
Single marking tag for pitch insert		CNU/10/51 (cod. NU1051S)	CNU/10/51 (cod. NU1051S)	CNU/10/51 (cod. NU1051S)
End bracket	Screw TH35	BT/3 (cod. BT003)	BT/3 (cod. BT003)	BT/3 (cod. BT003)
	Snap-fit TH35	BTO (cod. BT007)	BTO (cod. BT007)	BTO (cod. BT007)



- Reduced wiring time
- Wire release button

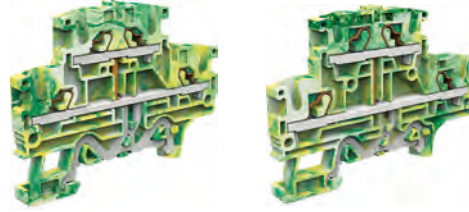

	IMQ 18 ATEX 007U	IECEX IMQ 18.0002U
	I M2 Ex eb I Mb	Ex eb I Mb
	II 2G Ex eb IIC Gb	Ex eb IIC Gb

(1) See chapter accessories for more details

YELLOW/GREEN VERSION	CODE TYPE	EFDE200 EFDE.2	EFDE400 EFDE.4
----------------------	-----------	----------------	----------------

TECHNICAL CHARACTERISTICS

Function/type		2 levels earth terminal blocks	2 levels earth terminal blocks
Rated cross-section	(mm ²)	2,5	4
Connecting capacity	Flexible (mm ²)	0,2 ÷ 4	0,2 ÷ 6
	Rigid (mm ²)	0,2 ÷ 4	0,2 ÷ 6
	Max.flexible with ferrule - ferrule type (mm ²)	2,5 - WP25/19	4 - WP40/16
Electrical characteristics According to European standard IEC EN 60947-7-2	Max AC/DC Voltage (V)	-	-
	Max current with rated cross-section (A)	-	-
	Section Caliber	A3	A4
Electrical characteristics According to UL	Max AC/DC Voltage (V)	-	-
	Max current with rated cross-section (A)	-	-
	Section Min-Max (AWG)	25-12	24-10
Electrical characteristics According to ATEX directive and IEC ex standard	Max AC/DC Voltage (V)	-	-
	Max current with rated cross-section (A)	18	25
	Operating temperature (°C)	-40+110	-40+110
Rated impulse withstand voltage/pollution degree		6kV / 3	6kV / 3
Insulation stripping length (mm)		9	10
Width (mm)		5.2	6.2
Length (mm)		71.6	81.7
Height mounted on TH35/7,5 (mm)		53.8	57.7
Height mounted on TH35/15 (mm)		61.3	65.2
Insulation material temperature index (EN 60216-1) (°C)		130	130
Plastic material		polyamide UL94V-0	polyamide UL94V-0

APPROVALS



ACCESSORIES			
End section	Grey	EFD.2/PT/GR (cod. EFD2016R)	EFD.4/PT/GR (cod. EFD4016R)
	Blue	EFD.2/PT/BL (cod. EFD201BL)	EFD.4/PT/BL (cod. EFD401BL)
	Thickness (mm)	1.5	1.5
Cross connection	(1)	EFB.2/.../... (cod. EFB02...)	EFB.4/.../... (cod. EFB04...)
	Rated current / Rated current ATEX applications (A)	22 / 18	29 / 25
Coloured partition	red	DFE.2P/R (cod. DFE04R)	DFE.2P/R (cod. DFE04R)
105mm adhesive numbering strip		-	-
105mm snap numbering strip		-	-
Single marking tag		CNU/10/51 (cod. NU1051S)	CNU/10/51 (cod. NU1051S)
Single marking tag for pitch insert		CNU/10/51 (cod. NU1051S)	CNU/10/51 (cod. NU1051S)
End bracket	Screw TH35	BT/3 (cod. BT003)	BT/3 (cod. BT003)
	Snap-fit TH35	BTO (cod. BT007)	BTO (cod. BT007)

- Reduced wiring time
- Wire release button

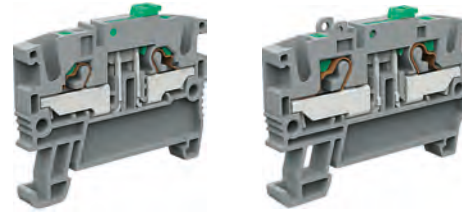

[1] See chapter accessories for more details

GREY VERSION	CODE	EFS200GR	EFS.2/GR	EFS400GR	EFS.4/GR
	TYPE				
BLUE VERSION	CODE	EFS200BL	EFS.2/BL	EFS400BL	EFS.4/BL
	TYPE				

TECHNICAL CHARACTERISTICS

Function/type		disconnectable with blade	disconnectable with blade
Rated cross-section	(mm ²)	2.5	4
Connecting capacity	Flexible (mm ²)	0,2 ÷ 4	0,2 ÷ 6
	Rigid (mm ²)	0,2 ÷ 4	0,2 ÷ 6
	Max.flexible with ferrule - ferrule type (mm ²)	2,5 - WP25/19	4 - WP40/16
Electrical characteristics According to European standard IEC EN 60947-7-1	Max AC/DC Voltage (V)	630	630
	Max current with rated cross-section (A)	13	26
	Section Caliber	A3	A4
Electrical characteristics According to UL	Max AC/DC Voltage (V)	300	600
	Max current with rated cross-section (A)	12	18.5
	Section Min-Max (AWG)	24-12	24-10
Electrical characteristics According to ATEX directive and IEC ex standard	Max AC/DC Voltage (V)	-	-
	Max current with rated cross-section (A)	-	-
	Operating temperature (°C)	-	-
Rated impulse withstand voltage/pollution degree		4kV / 3	4kV / 3
Insulation stripping length (mm)		9	10
Width (mm)		5.2	6.2
Length (mm)		49.6	55.2
Height mounted on TH35/7,5 (mm)		41.2	41.2
Height mounted on TH35/15 (mm)		48.7	48.7
Insulation material temperature index (EN 60216-1) (°C)		130	130
Plastic material		polyamide UL94V-0	polyamide UL94V-0

APPROVALS



ACCESSORIES			
End section	Grey	EFC.2/PT/GR (cod. EFC201GR)	EFC.4/PT/GR (cod. EFC401GR)
	Blue	EFC.2/PT/BL (cod. EFC201BL)	EFC.4/PT/BL (cod. EFC401BL)
	Thickness (mm)	1,5	1,5
Cross connection	[1]	EFB.2/.../... (cod. EFB02...)	EFB.4/.../... (cod. EFB04...)
	Rated current / Rated current ATEX applications (A)	24	32
Coloured partition	red	DFE.1+1/R (cod. DFE01R)	DFE.1+1/R (cod. DFE01R)
105mm adhesive numbering strip		-	-
105mm snap numbering strip		-	-
Single marking tag		CNU/10/51 (cod. NU1051S)	CNU/10/51 (cod. NU1051S)
Single marking tag for pitch insert		CNU/10/51 (cod. NU1051S)	CNU/10/51 (cod. NU1051S)
End bracket	Screw TH35	BT/3 (cod. BT003)	BT/3 (cod. BT003)
	Snap-fit TH35	BTO (cod. BT007)	BTO (cod. BT007)

EFT.2 SERIES

SPRING CLAMP TERMINAL BLOCKS WITH 3 LEVELS AND PUSH-IN TECHNOLOGY



- Reduced wiring time
- Wire release button

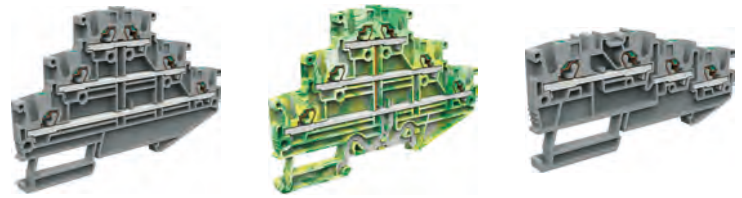

	IMQ 18 ATEX 007U	IECEX IMQ 18.0002U
	I M2 Ex eb I Mb	Ex eb I Mb
	II 2G Ex eb IIC Gb	Ex eb IIC Gb

(1) See chapter accessories for more details

GREY VERSION	CODE	EFT200GR	EFT.2/GR	EFT250GR	EFT.2/S/GR
BLUE VERSION	TYPE	EFT200BL	EFT.2/BL		
YELLOW/GREEN VERSION	TYPE			EFTE200	EFTE.2

TECHNICAL CHARACTERISTICS

Function/type		3 levels	3 levels + earth	3 levels – for sensors	
Rated cross-section	(mm ²)	2,5	2,5	2,5	
Connecting capacity	Flexible	0,2 ÷ 4	0,2 ÷ 4	0,2 ÷ 4	
	Rigid	0,2 ÷ 4	0,2 ÷ 4	0,2 ÷ 4	
	Max.flexible with ferrule - ferrule type	(mm ²)	2,5 - WP25/19	2,5 - WP25/19	2,5 - WP25/19
Electrical characteristics According to European standard IEC EN 60947-7-1	Max AC/DC Voltage	(V)	800	800	250
	Max current with rated cross-section	(A)	24	-	23
Electrical characteristics According to UL	Section	Caliber	A3	A3	A3
	Max AC/DC Voltage	(V)	600	600	300
	Max current with rated cross-section	(A)	20	-	20
Electrical characteristics According to ATEX directive and IEC ex standard	Section Min-Max	[AWG]	24-12	24-12	24-12
	Max AC/DC Voltage	(V)	320	-	200
Rated impulse withstand voltage/pollution degree	Max current with rated cross-section	(A)	20	20	21
	Operating temperature	(°C)	-40+110	-40+110	-40+110
Insulation stripping length	(mm)	9	9	9	
Width	(mm)	5.2	5.2	5.2	
Length	(mm)	106.2	106.2	89	
Height mounted on TH35/7,5	(mm)	68.4	68.4	43.9	
Height mounted on TH35/15	(mm)	75.9	75.9	51.4	
Insulation material temperature index (EN 60216-1)	(°C)	130	130	130	
Plastic material		polyamide UL94V-0	polyamide UL94V-0	polyamide UL94V-0	

APPROVALS



ACCESSORIES		EFT.2/PT/GR (cod. EFT201GR)	EFT.2/S/PT/GR (cod. EFT251GR)
End section	Grey	EFT.2/PT/GR (cod. EFT201GR)	EFT.2/S/PT/GR (cod. EFT251GR)
	Blue	EFT.2/PT/BL (cod. EFT201BL)	-
Cross connection	Thickness (mm)	1.5	1.5
	(1)	EFB.2/.../... (cod. EFB02...)	EFB.2/.../... (cod. EFB02...)
Coloured partition	Rated current / Rated current ATEX applications (A)	24 / 18	24 / 18
	red	-	-
105mm adhesive numbering strip		-	-
105mm snap numbering strip		-	-
Single marking tag		CNU/10/51 (cod. NU1051S)	CNU/10/51 (cod. NU1051S)
Single marking tag for pitch insert		CNU/10/51 (cod. NU1051S)	CNU/10/51 (cod. NU1051S)
End bracket	Screw TH35	BT/3 (cod. BT003)	BT/3 (cod. BT003)
	Snap-fit TH35	BTO (cod. BT007)	BTO (cod. BT007)

- Reduced wiring time
- Wire release button

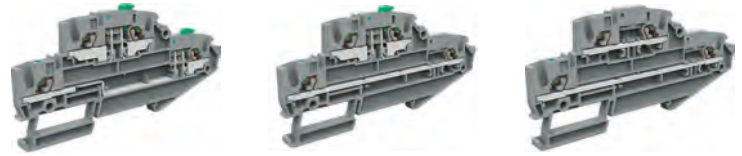

(1) See chapter accessories for more details

GREY VERSION		CODE TYPE	EFDS200GR EFDS.2/GR	EFDS210GR EFDS.2/1S/GR	EFDS220GR EFDS.2/P/GR
TECHNICAL CHARACTERISTICS					
Function/type			2 levels disconnect	2 levels disconnect (disconnectable upper level + feed-trough on lower)	2 levels Feed-through
Rated cross-section		(mm ²)	2.5	2.5	2.5
Connecting capacity		Flexible	0,2 ÷ 4	0,2 ÷ 4	0,2 ÷ 4
		Rigid	0,2 ÷ 4	0,2 ÷ 4	0,2 ÷ 4
		Max.flexible with ferrule - ferrule type	2,5 - WP25/19	2,5 - WP25/19	2,5 - WP25/19
Electrical characteristics According to European standard IEC EN 60947-7-1		Max AC/DC Voltage	630	630	630
		Max current with rated cross-section	17	17	20
		Section	Caliber A3	A3	A3
Electrical characteristics According to UL		Max AC/DC Voltage	300	300	300
		Max current with rated cross-section	12	12	20
		Section Min-Max	[AWG] 24-12	24-12	24-12
Electrical characteristics According to ATEX directive and IEC ex standard		Max AC/DC Voltage	-	-	-
		Max current with rated cross-section	-	-	-
		Operating temperature	-	-	-
Rated impulse withstand voltage/pollution degree			6kV / 3	6kV / 3	6kV / 3
Insulation stripping length		(mm)	9	9	9
Width		(mm)	5.2	5.2	5.2
Length		(mm)	110	110	110
Height mounted on TH35/7,5		(mm)	54	54	54.5
Height mounted on TH35/15		(mm)	61.5	61.5	62
Insulation material temperature index (EN 60216-1)		(°C)	130	130	130
Plastic material			polyamide UL94V-0	polyamide UL94V-0	polyamide UL94V-0
APPROVALS					
ACCESSORIES					
End section		Grey	EFDS.2/PT/GR (cod. EFDS201GR)	EFDS.2/PT/GR (cod. EFDS201GR)	EFDS.2/PT/GR (cod. EFDS201GR)
		Blue	-	-	-
		Thickness	(mm) 1.5	1.5	1.5
Cross connection		(1)	EFB.2/.../... (cod. EFB02...)	EFB.2/.../... (cod. EFB02...)	EFB.2/.../... (cod. EFB02...)
		Rated current / Rated current ATEX applications	[A] 17/-	17/-	20/-
Coloured partition		red	-	-	-
105mm adhesive numbering strip			-	-	-
105mm snap numbering strip			-	-	-
Single marking tag			CNU/10/51 (cod. NU1051S)	CNU/10/51 (cod. NU1051S)	CNU/10/51 (cod. NU1051S)
Single marking tag for pitch insert			CNU/10/51 (cod. NU1051S)	CNU/10/51 (cod. NU1051S)	CNU/10/51 (cod. NU1051S)
End bracket		Screw TH35	BT/3 (cod. BT003)	BT/3 (cod. BT003)	BT/3 (cod. BT003)
		Snap-fit TH35	BTO (cod. BT007)	BTO (cod. BT007)	BTO (cod. BT007)

EFF.4

FUSE-HOLDER TERMINAL BLOCKS WITH PUSH-IN TECHNOLOGY



- Reduced wiring time
- Wire release button



[1] See chapter accessories for more details

GREY VERSION	CODE	EFF400GR	EFF448GR	EFF423GR
	TYPE	EFF.4/GR	EFF.4/C48/GR	EFF.4/C230/GR
BLUE VERSION	CODE	EFF400BL		
	TYPE	EFF.4/BL		

TECHNICAL CHARACTERISTICS

Function/type		Fuse-holders 5x20	Fuse-holders 5x20 with led	Fuse-holders 5x20 with led
Rated cross-section	(mm ²)	4	4	4
Connecting capacity	Flexible	0,2 ÷ 6	0,2 ÷ 6	0,2 ÷ 6
	Rigid	0,2 ÷ 6	0,2 ÷ 6	0,2 ÷ 6
	Max.flexible with ferrule - ferrule type	4 - WP40/16	4 - WP40/16	4 - WP40/16
Electrical characteristics According to European standard IEC EN 60947-7-1	Max AC/DC Voltage	(V) 630	48	230
	Max current with rated cross-section	(A) 6.3	6.3	6.3
	Section	Caliber A4	A4	A4
Electrical characteristics According to UL	Max AC/DC Voltage	(V) 600	48	230
	Max current with rated cross-section	(A) 6.3	6.3	6.3
	Section Min-Max	(AWG) 24-10	24-10	24-10
Rated impulse withstand voltage/pollution degree		4kV / 3	4kV / 3	4kV / 3
Insulation stripping length	(mm)	10	10	10
Width	(mm)	6.2	6.2	6.2
Length	(mm)	55.2	55.2	55.2
Height mounted on TH35/7,5	(mm)	67.1	67.1	67.1
Height mounted on TH35/15	(mm)	74.6	74.6	74.6
Insulation material temperature index (EN 60216-1)	(°C)	130	130	130
Plastic material		polyamide UL94V-0	polyamide UL94V-0	polyamide UL94V-0

APPROVALS



ACCESSORIES				
End section	Grey	EFD.4/PT/GR (cod. EFD401GR)	EFD.4/PT/GR (cod. EFD401GR)	EFD.4/PT/GR (cod. EFD401GR)
	Blue	EFD.4/PT/BL (cod. EFD401BL)	EFD.4/PT/BL (cod. EFD401BL)	EFD.4/PT/BL (cod. EFD401BL)
	Thickness	(mm) 1.5	1.5	1.5
Cross connection	Rated current	(A) 32A	32A	32A
		EFB.4/.../... (cod. EFB04...)	EFB.4/.../... (cod. EFB04...)	EFB.4/.../... (cod. EFB04...)
Coloured partition	red	DFF.1+1/R (cod. DFF01R)	DFF.1+1/R (cod. DFF01R)	DFF.1+1/R (cod. DFF01R)
Miniature fuse		F5/... (cod. FN...)	F5/... (cod. FN...)	F5/... (cod. FN...)
Led circuit (contains 2 contact slats, 1 led microcircuits)	For voltage 12V 24V 48V AC/DC	CIL/12-24-48 (cod. CB518)	already installed	-
	For voltage 115V 230V AC/DC	CIL/115-230 (cod. CB523)	-	already installed
Single marking tag		CNU/10/51 (cod. NU1051S)	CNU/10/51 (cod. NU1051S)	CNU/10/51 (cod. NU1051S)
Single marking tag for pitch insert		CNU/10/61 (cod. NU1061S)	CNU/10/61 (cod. NU1061S)	CNU/10/61 (cod. NU1061S)
End bracket	Screw TH35	BT/3 (cod. BT003)	BT/3 (cod. BT003)	BT/3 (cod. BT003)
	Snap-fit TH35	BTO (cod. BT007)	BTO (cod. BT007)	BTO (cod. BT007)

Blank lined area for notes.

Spring-Clamp Terminal Blocks

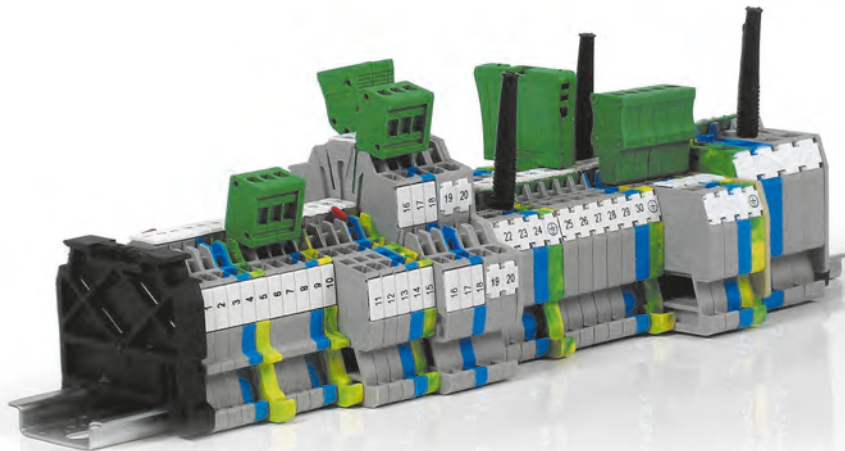

SPRING CLAMP



INERIS 16 ATEX 9002 UI	IECEx INE 16.0032U
I M2 Ex e I Mb	Ex e I Mb
II 2 G Ex E IIC Gb	Ex e IIC Gb

For the creation of high harness volumes, for conductors from 0.2 to 25 mm² and reduced current intensity values, CABUR proposes its range of spring-clamp terminal blocks.

To protect the clamping system, the insulating body includes a stopper which prevents the spring from going beyond the threshold of its elastic field, if is activated by inexperienced hands.

Adequate sizing of the wire introduction chamber, responding to the requirements of the IEC 60947-1 Standard, guarantees insertion of any type of conductor of the nominal size, also butted with a terminal.

The connection that results from this, in relation to the technology adopted, has the maximum reliability and safety thanks to the quality of the materials used and to the particular conformation of the components needed

for the purpose, avoiding damage to the strands of the conductors in the presence of unprepared flexible wires.

The wire entry is perpendicular to the installation surface determining a further reduction of times and costs of the wiring operations above all where the spaces are particularly limited.

To connect together several contiguous elements, a practical and safe bridging system is available.

Terminal blocks with rated cross-sections of between 1.5 and 16 mm² have the possibility of being connected together in the most disparate ways thanks to our exclusive "Easy Bridge" rapid connection system (PTC), which combines efficiency, rapidity and flexibility providing at the same time a exceptional economic result; these characteristics together with the resulting **IPXXB intrinsic installation without the aid of further insulation protections** (of wires, terminal blocks and parallel connections), guarantees better connectivity than that offered by the competitors.

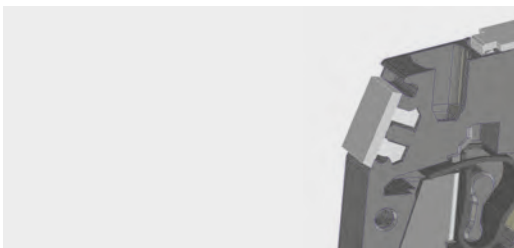

CNU/8

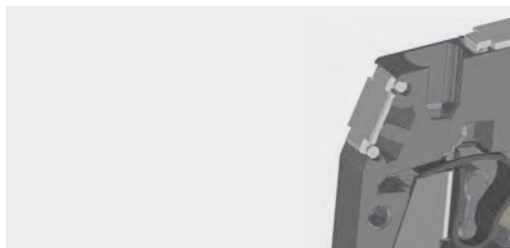

SHZ

MARKING SYSTEMS

In our marking system the same multiple numbering strip (SHZ) can be inserted on the sides of the terminal block or in the specific seats present in the upper part of the terminal block itself.

This means easy identification of each terminal block from every viewing angle within the electrical panel. The numbering can be done also with the single standard-type **CNU/8** tags.

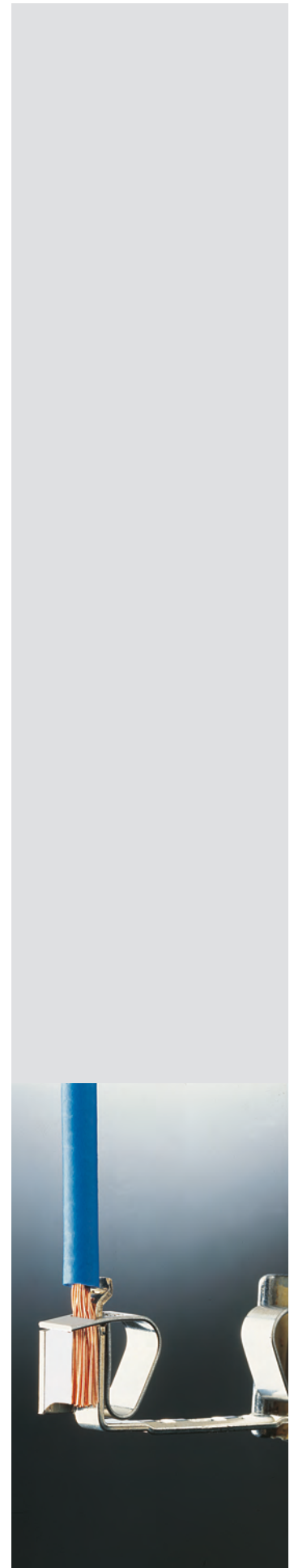



INERIS 16 ATEX 9002 U
I M2 Ex e I Mb
II 2 G Ex E IIC Gb

IECEX I NE 16.0032U
Ex e I Mb
Ex e IIC Gb

(1) See chapter accessories for more details

GREY VERSION	CODE	HM400GR	HM410GR	HM420GR
	TYPE	HMM.1/GR	HMM.1/1+2/GR	HMM.1/2+2/GR
BLUE VERSION	CODE	HI400	HI410	HI420
	TYPE	HMM.1 (EX)I	HMM.1/1+2 (EX)I	HMM.1/2+2 (EX)I

TECHNICAL CHARACTERISTICS

Function/type		feed-through	feed-through	feed-through
Rated cross-section	(mm ²)	1.5	1.5	1.5
Connecting capacity	Flexible (mm ²)	0.2-2.5	0.2-2.5	0.2-2.5
	Rigid (mm ²)	0.2-2.5	0.2-2.5	0.2-2.5
	Max. flexible with ferrule - ferrule type (mm ²)	1.5-WP15/14	1.5-WP15/14	1.5-WP15/14
Electrical characteristics According to European standard IEC EN 60947-7-1	Max AC/DC Voltage (V)	500	500	500
	Max current with rated cross-section (A)	17.5	17.5	17.5
	Section (Caliber)	B2	B2	B2
Electrical characteristics According to UL	Max AC/DC Voltage (V)	600	600	600
	Max current with rated cross-section (A)	15	15	15
	Section Min - Max (AWG)	26-14	26-14	26-14
Electrical characteristics According to ATEX directive and IEC ex standard	Max AC/DC voltage (V)	400	400	400
	Max current with rated cross-section (A)	17.5	17.5	17.5
	Operating temperature (°C)	-40 +80	-40 +80	-40 +80
Rated impulse withstand voltage/pollution degree		8 KV / 3	8 KV / 3	8 KV / 3
Insulation stripping length (mm)		10	10	10
Width (mm)		45	56	65
Length (mm)		4.2	4.2	4.2
Height mounted on TH35/7.5 (mm)		43	43	43
Height mounted on TH35/15 (mm)		51	51	51
Insulation material temperature index (EN 60216-1) (°C)		130	130	130
Plastic material		polyamide UL94V-0	polyamide UL94V-0	polyamide UL94V-0

APPROVALS



ACCESSORIES

End section	Grey	HMT.1/PT/GR (cod. HM401GR)	HMT.1/1+2/PT/GR (cod. HM411GR)	HMT.1/2+2/PT/GR (cod. HM421GR)
	Blue	HMT.1/PT (Ex)i (cod. HI401)	HMT.1/1+2/PT (Ex)i (cod. HI411)	HMT.1/2+2/PT (Ex)i (cod. HI421)
	Thickness (mm)	1.5	1.5	1.5
Cross connection	PTC version (1)	PTC/1/... (cod. PTC01...)	PTC/1/... (cod. PTC01...)	PTC/1/... (cod. PTC01...)
	PTP version (1)	-	-	-
	Rated current (A)	17.5	17.5	17.5
Cross-connection identification strip	green	PTC/SP (cod. PTC0990)	PTC/SP (cod. PTC0990)	PTC/SP (cod. PTC0990)
Coloured partition	red	DFH/1/R (cod. DH01R)	DFH/2/R (cod. DH02R)	DFH/3/R (cod. DH03R)
Cross connection barrier	red	DFM/500 (cod. DF500)	DFM/500 (cod. DF500)	DFM/500 (cod. DF500)
Test plug		-	-	-
Modular test plug		SDH/4 (cod. DH004)	SDH/4 (cod. DH004)	SDH/4 (cod. DH004)
End section for modular test plug		SH4/PT (cod. DH401)	SH4/PT (cod. DH401)	SH4/PT (cod. DH401)
Numbering strip		SHZ/1 (cod. SH004)	SHZ/1 (cod. SH004)	SHZ/1 (cod. SH004)
Screwdriver for activation of the spring		CCH/2.5-4 (cod. CCH02)	CCH/2.5-4 (cod. CCH02)	CCH/2.5-4 (cod. CCH02)
Marking tag		SHZ/1 (cod. SH004)	SHZ/1 (cod. SH004)	SHZ/1 (cod. SH004)
End bracket	Snap-fit TH35 and G32	BTU (cod. BT005)	BTU (cod. BT005)	BTU (cod. BT005)
	Snap-fit TH35	BTO (cod. BT007)	BTO (cod. BT007)	BTO (cod. BT007)
	Screw TH35	BT/3 (cod. BT003)	BT/3 (cod. BT003)	BT/3 (cod. BT003)



INERIS 16 ATEX 9002 U
I M2 Ex e I Mb
II 2 G Ex E IIC Gb

IECEX I NE 16.0032U
Ex e I Mb
Ex e IIC Gb

(1) See chapter accessories for more details

GREY VERSION	CODE	HM500GR	HM510GR	HM520GR
	TYPE	HMM.2/GR	HMM.2/1+2/GR	HMM.2/2+2/GR
BLUE VERSION	CODE	HI500	HI510	HI520
	TYPE	HMM.2 (EX)I	HMM.2/1+2 (EX)I	HMM.2/2+2 (EX)I

TECHNICAL CHARACTERISTICS

Function/type		feed-through	feed-through	feed-through
Rated cross-section	(mm ²)	2.5	2.5	2.5
Connecting capacity	Flexible (mm ²)	0.2-4	0.2-4	0.2-4
	Rigid (mm ²)	0.2-4	0.2-4	0.2-4
	Max. flexible with ferrule - ferrule type (mm ²)	2.5-WP25/14	2.5-WP25/14	2.5-WP25/14
Electrical characteristics According to European standard IEC EN 60947-7-1	Max AC/DC Voltage (V)	800	800	800
	Max current with rated cross-section (A)	24	24	24
	Section (Caliber)	A3	A3	A3
Electrical characteristics According to UL	Max AC/DC Voltage (V)	600	600	600
	Max current with rated cross-section (A)	20	20	20
	Section Min - Max (AWG)	24-12	24-12	24-12
Electrical characteristics According to ATEX directive and IEC ex standard	Max AC/DC voltage (V)	500	500	500
	Max current with rated cross-section (A)	24	24	24
	Operating temperature (°C)	-40 +80	-40 +80	-40 +80
Rated impulse withstand voltage/pollution degree		8 KV / 3	8 KV / 3	8 KV / 3
Insulation stripping length (mm)		10	10	10
Width (mm)		50	66	82
Length (mm)		5.2	5.2	5.2
Height mounted on TH35/7.5 (mm)		41	41	41
Height mounted on TH35/15 (mm)		49	49	49
Insulation material temperature index (EN 60216-1) (°C)		130	130	130
Plastic material		polyamide UL94V-0	polyamide UL94V-0	polyamide UL94V-0

APPROVALS



ACCESSORIES				
End section	Grey	HMT.2/PT/GR (cod. HM501GR)	HMT.2/1+2/PT/GR (cod. HM511GR)	HMT.2/2+2/PT/GR (cod. HM521GR)
	Blue	HMT.2/PT (Ex)i (cod. HI501)	HMT.2/1+2/PT (Ex)i (cod. HI511)	HMT.2/2+2/PT (Ex)i (cod. HI521)
	Thickness (mm)	1.5	1.5	1.5
Cross connection	PTC version (1)	PTC/03/... (cod. PTC03...)	PTC/03/... (cod. PTC03...)	PTC/03/... (cod. PTC03...)
	PTP version (1)	PTP/03/... (cod. PTP03...)	PTP/03/... (cod. PTP03...)	PTP/03/... (cod. PTP03...)
	Rated current (A)	24	24	24
Cross-connection identification strip	green	PTC/SP (cod. PTC0990)	PTC/SP (cod. PTC0990)	PTC/SP (cod. PTC0990)
Coloured partition	red	DFH/1/R (cod. DH01R)	DFH/2/R (cod. DH02R)	DFH/3/R (cod. DH03R)
Cross connection barrier	red	-	-	-
Test plug		SDD/1 (cod. DD001)	SDD/1 (cod. DD001)	SDD/1 (cod. DD001)
Modular test plug		SDH/5 (cod. DH005)	SDH/5 (cod. DH005)	SDH/5 (cod. DH005)
End section for modular test plug		SH5/PT (cod. DH501)	SH5/PT (cod. DH501)	SH5/PT (cod. DH501)
Numbering strip		CNU/8/51 (cod. NU0851S)	CNU/8/51 (cod. NU0851S)	CNU/8/51 (cod. NU0851S)
Screwdriver for activation of the spring		CCH/2.5-4 (cod. CCH02)	CCH/2.5-4 (cod. CCH02)	CCH/2.5-4 (cod. CCH02)
Marking tag		CNU/8/51 (cod. NU0851S)	CNU/8/51 (cod. NU0851S)	CNU/8/51 (cod. NU0851S)
End bracket	Snap-fit TH35 and G32	BTU (cod. BT005)	BTU (cod. BT005)	BTU (cod. BT005)
	Snap-fit TH35	BTO (cod. BT007)	BTO (cod. BT007)	BTO (cod. BT007)
	Screw TH35	BT/3 (cod. BT003)	BT/3 (cod. BT003)	BT/3 (cod. BT003)



[1] See chapter accessories for more details

GREY VERSION	CODE	HMS20GR	HM170GR	HMS10GR
BLUE VERSION	TYPE	HMM.2/1+2/S/GR	HMM.2/2+2/A/GR	HMM.2/2+2/S/GR

TECHNICAL CHARACTERISTICS					
Function/type		disconnect	disconnect (open version)	disconnect	
Rated cross-section	(mm ²)	2.5	2.5	2.5	
Connecting capacity	Flexible (mm ²)	0.2-4	0.2-4	0.2-4	
	Rigid (mm ²)	0.2-4	0.2-4	0.2-4	
	Max. flexible with ferrule - ferrule type (mm ²)	2.5-WP25/14	2.5-WP25/14	2.5-WP25/14	
Electrical characteristics According to European standard IEC EN 60947-7-1	Max AC/DC Voltage (V)	400	400	400	
	Max current with rated cross-section (A)	16	16	16	
	Section (Caliber)	A3	A3	A3	
Electrical characteristics According to UL	Max AC/DC Voltage (V)	-	-	-	
	Max current with rated cross-section (A)	-	-	-	
	Section Min - Max (AWG)	-	-	-	
Electrical characteristics According to ATEX directive and IEC ex standard	Max AC/DC voltage (V)	-	-	-	
	Max current with rated cross-section (A)	-	-	-	
	Operating temperature (°C)	-	-	-	
Rated impulse withstand voltage/pollution degree		6 KV / 3	6 KV / 3	6 KV / 3	
Insulation stripping length (mm)		10	10	10	
Width (mm)		66	82	82	
Length (mm)		5.2	5.2	5.2	
Height mounted on TH35/7.5 (mm)		48	37	48	
Height mounted on TH35/15 (mm)		56	45	56	
Insulation material temperature index (EN 60216-1) (°C)		130	130	130	
Plastic material		polyamide UL94V-0	polyamide UL94V-0	polyamide UL94V-0	

APPROVALS				
-----------	--	--	--	--

ACCESSORIES				
End section	Grey	HMT.2/1+2/PT/GR (cod. HM511GR)	HMT.2/2+2/PT/GR (cod. HM521GR)	HMT.2/2+2/PT/GR (cod. HM521GR)
	Blue	-	-	-
Cross connection	Thickness (mm)	1.5	1.5	1.5
	PTC version [1]	-	-	-
	PTP version [1]	-	-	-
Cross-connection identification strip	Rated current (A)	-	-	-
	green	-	-	-
Coloured partition	red	DFH/2/R (cod. DH02R)	DFH/3/R (cod. DH03R)	DFH/3/R (cod. DH03R)
Cross connection barrier	red	-	-	-
Test plug		SDD/1 (cod. DD001)	SDD/1 (cod. DD001)	SDD/1 (cod. DD001)
Modular test plug		SDH/5 (cod. DH005)	SDH/5 (cod. DH005)	SDH/5 (cod. DH005)
End section for modular test plug		SH5/PT (cod. DH501)	SH5/PT (cod. DH501)	SH5/PT (cod. DH501)
Numbering strip		CNU/8/51 (cod. NU0851S)	CNU/8/51 (cod. NU0851S)	CNU/8/51 (cod. NU0851S)
Screwdriver for activation of the spring		CCH/2.5-4 (cod. CCH02)	CCH/2.5-4 (cod. CCH02)	CCH/2.5-4 (cod. CCH02)
Marking tag		CNU/8/51 (cod. NU0851S)	CNU/8/51 (cod. NU0851S)	CNU/8/51 (cod. NU0851S)
End bracket	Snap-fit TH35 and G32	BTU (cod. BT005)	BTU (cod. BT005)	BTU (cod. BT005)
	Snap-fit TH35	BTO (cod. BT007)	BTO (cod. BT007)	BTO (cod. BT007)
	Screw TH35	BT/3 (cod. BT003)	BT/3 (cod. BT003)	BT/3 (cod. BT003)



INERIS 16 ATEX 9002 U
I M2 Ex e I Mb
II 2 G Ex E IIC Gb

IECEX I NE 16.0032U
Ex e I Mb
Ex e IIC Gb

(1) See chapter accessories for more details

GREY VERSION	CODE	HM250GR	HM210GR	HM220GR
	TYPE	HMM.4/GR	HMM.4/1+2/GR	HMM.4/2+2/GR
BLUE VERSION	CODE	HI250	HI210	HI220
	TYPE	HMM.4 (EX)I	HMM.4/1+2 (EX)I	HMM.4/2+2 (EX)I

TECHNICAL CHARACTERISTICS

Function/type		feed-through	feed-through	feed-through
Rated cross-section	(mm ²)	4	4	4
Connecting capacity	Flexible (mm ²)	0.2-6	0.2-6	0.2-6
	Rigid (mm ²)	0.2-6	0.2-6	0.2-6
	Max. flexible with ferrule - ferrule type (mm ²)	4-WP40/16	4-WP40/16	4-WP40/16
Electrical characteristics According to European standard IEC EN 60947-7-1	Max AC/DC Voltage (V)	800	800	800
	Max current with rated cross-section (A)	32	32	32
	Section (Caliber)	A4	A4	A4
Electrical characteristics According to UL	Max AC/DC Voltage (V)	600	600	600
	Max current with rated cross-section (A)	30	30	30
	Section Min - Max (AWG)	28 -10	28 -10	28 -10
Electrical characteristics According to ATEX directive and IEC ex standard	Max AC/DC voltage (V)	500	500	500
	Max current with rated cross-section (A)	32	32	32
	Operating temperature (°C)	-40 +80	-40 +80	-40 +80
Rated impulse withstand voltage/pollution degree		8 KV / 3	8 KV / 3	8 KV / 3
Insulation stripping length (mm)		12	12	12
Width (mm)		58	78	98
Length (mm)		6.2	6.2	6.2
Height mounted on TH35/7.5 (mm)		45	45	45
Height mounted on TH35/15 (mm)		52	52	52
Insulation material temperature index (EN 60216-1) (°C)		130	130	130
Plastic material		polyamide UL94V-0	polyamide UL94V-0	polyamide UL94V-0

APPROVALS



ACCESSORIES

End section	Grey	HMT.4/PT/GR (cod. HM251GR)	HMT.4/1+2/PT/GR (cod. HM211GR)	HMT.4/1+2/PT/GR (cod. HM211GR)
	Blue	HMT.4/PT (Ex)i (cod. HI251)	HMT.4/1+2/PT (Ex)i (cod. HI211)	HMT.4/1+2/PT (Ex)i (cod. HI211)
	Thickness (mm)	1.5	1.5	1.5
Cross connection	PTC version (1)	PTC/5/... (cod. PTC05...)	PTC/5/... (cod. PTC05...)	PTC/5/... (cod. PTC05...)
	PTP version (1)	PTP/5/... (cod. PTP05...)	PTP/5/... (cod. PTP05...)	PTP/5/... (cod. PTP05...)
	Rated current (A)	32	32	32
Cross-connection identification strip	green	PTC/SP (cod. PTC0990)	PTC/SP (cod. PTC0990)	PTC/SP (cod. PTC0990)
Coloured partition	red	DFH/1/R (cod. DH01R)	DFH/4/R (cod. DH04R)	DFH/4/R (cod. DH04R)
Cross connection barrier	red	-	-	-
Test plug		SDD/1 (cod. DD001)	SDD/1 (cod. DD001)	SDD/1 (cod. DD001)
Modular test plug		SDH/6 (cod. DH006)	SDH/6 (cod. DH006)	SDH/6 (cod. DH006)
End section for modular test plug		SH6/PT (cod. DH601)	SH6/PT (cod. DH601)	SH6/PT (cod. DH601)
Numbering strip		CNU/8/61 (cod. NU0861S)	CNU/8/61 (cod. NU0861S)	CNU/8/61 (cod. NU0861S)
Screwdriver for activation of the spring		CCH/2.5-4 (cod. CCH02)	CCH/2.5-4 (cod. CCH02)	CCH/2.5-4 (cod. CCH02)
Marking tag		CNU/8/61 (cod. NU0861S)	CNU/8/51 (cod. NU0851S)	CNU/8/61 (cod. NU0861S)
End bracket	Snap-fit TH35 and G32	BTU (cod. BT005)	BTU (cod. BT005)	BTU (cod. BT005)
	Snap-fit TH35	BTO (cod. BT007)	BTO (cod. BT007)	BTO (cod. BT007)
	Screw TH35	BT/3 (cod. BT003)	BT/3 (cod. BT003)	BT/3 (cod. BT003)



INERIS 16 ATEX 9002 U
I M2 Ex e I Mb
II 2 G Ex E IIC Gb

IECEX INE 16.0032U
Ex e I Mb
Ex e IIC Gb

(1) See chapter accessories for more details

GREY VERSION	CODE	HM320GR	HM330GR	HM340GR
	TYPE	HMM.6/GR	HMM.10/GR	HMM.16/GR
BLUE VERSION	CODE	HI320	HI330	HI340
	TYPE	HMM.4 (EX)I	HMM.10 (EX)I	HMM.16 (EX)I

TECHNICAL CHARACTERISTICS

Function/type		feed-through	feed-through	feed-through
Rated cross-section	(mm ²)	6	10	16
Connecting capacity	Flexible (mm ²)	0.2-10	1.5-16	1.5-25
	Rigid (mm ²)	0.2-10	1.5-16	1.5-25
	Max. flexible with ferrule - ferrule type (mm ²)	6-WP60/20	10-WP100/21	16-WP160/22
Electrical characteristics According to European standard IEC EN 60947-7-1	Max AC/DC Voltage (V)	800	1000	1000
	Max current with rated cross-section (A)	41	57	76
	Section (Caliber)	A5	A6	A7
Electrical characteristics According to UL	Max AC/DC Voltage (V)	600	600	600
	Max current with rated cross-section (A)	41	57	85
	Section Min - Max (AWG)	24 - 8	20 - 6	18 - 4
Electrical characteristics According to ATEX directive and IEC ex standard	Max AC/DC voltage (V)	500	500	630
	Max current with rated cross-section (A)	41	57	76
	Operating temperature (°C)	-40 +80	-40 +80	-40 +80
Rated impulse withstand voltage/pollution degree		8 KV / 3	8 KV / 3	12 KV / 3
Insulation stripping length (mm)		13	18	18
Width (mm)		62	71	80
Length (mm)		8.2	10	12
Height mounted on TH35/7.5 (mm)		48	53	56
Height mounted on TH35/15 (mm)		56	61	64
Insulation material temperature index (EN 60216-1) (°C)		130	130	130
Plastic material		polyamide UL94V-0	polyamide UL94V-0	polyamide UL94V-0

APPROVALS



ACCESSORIES

End section	Grey	HMT.6/PT/GR (cod. HM321GR)	HMT.10/PT/GR (cod. HM331GR)	HMT.16/PT/GR (cod. HM341GR)
	Blue	HMT.6/PT (Ex)i (cod. HI321)	HMT.10/PT (Ex)i (cod. HI331)	HMT.16/PT (Ex)i (cod. HI341)
	Thickness (mm)	1.5	1.5	1.5
Cross connection	PTC version (1)	PTC/8/... (cod.PTC08...)	PTC/11/... (cod. PTC11...)	PTC/16/... (cod. PTC16...)
	PTP version (1)	-	-	-
	Rated current (A)	41	57	76
Cross-connection identification strip	green	PTC/SP (cod. PTC0990)	-	-
Coloured partition	red	DFH/1/R (cod. DH01R)	DFH/4/R (cod. DH04R)	DFH/4/R (cod. DH04R)
Cross connection barrier	red	-	-	-
Test plug		SDD/1 (cod. DD001)	SDD/1 (cod. DD001)	SDD/1 (cod. DD001)
Modular test plug		-	-	-
End section for modular test plug		-	-	-
Numbering strip		-	-	-
Screwdriver for activation of the spring		CCH/6 (cod. CCH06)	CCH/6 (cod. CCH06)	CCH/6 (cod. CCH06)
Marking tag		CNU/8/51 (cod. NU0851S)	CNU/8/51 (cod. NU0851S)	CNU/8/51 (cod. NU0851S)
		-	-	-
		-	-	-
End bracket	Snap-fit TH35 and G32	BTU (cod. BT005)	BTU (cod. BT005)	BTU (cod. BT005)
	Snap-fit TH35	BTO (cod. BT007)	BTO (cod. BT007)	BTO (cod. BT007)
	Screw TH35	BT/3 (cod. BT003)	BT/3 (cod. BT003)	BT/3 (cod. BT003)

- connectable with the terminal blocks: HMM.2/GR, HMM.2/1+2/GR, HMM.2/2+2/GR, HMS.2/GR, HMFA.2/GR, HMM.4/GR, HMM.4/1+2/GR, HMM.4/2+2/GR, HMM.6/GR

- (1) value referred to the terminal and not to the potential distributor
 (2) See chapter accessories for more details
 (3) The number of poles to be used shall be equal to the number of terminal blocks to be connected, including the distribution terminal block +1 to allow the connection to the distribution terminal block the second pin of the PTC jumper shall be trimmed off.

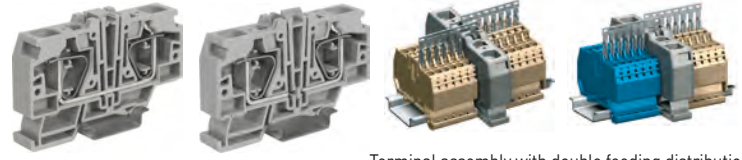

Terminal assembly with double feeding distribution

SINGLE POWER SUPPLY VERSION	CODE	HM350GR	
	TYPE		HMR.16/GR
DOUBLE SUPPLY VERSION	CODE	HM360GR	
	TYPE		HMR.16/D/GR

TECHNICAL CHARACTERISTICS

Function/type		feed-through
Rated cross-section	(mm ²)	16
Connecting capacity	Flexible (mm ²)	1.5-25
	Rigid (mm ²)	1.5-25
	Max.flexible with ferrule - ferrule type (mm ²)	16-WP160/22
Electrical characteristics According to European standard IEC EN 60947-7-1	Max AC/DC Voltage (V)	800
	Max current with rated cross-section (A)	76 (1)
	Section Caliber	A7
Electrical characteristics According to UL	Max AC/DC Voltage (V)	600
	Max current with rated cross-section (A)	30
	Section Min-Max (AWG)	18-4
Rated impulse withstand voltage/pollution degree		12 KV / 3
Insulation stripping length (mm)		18
Width (mm)		80
Length (mm)		12.8
Height mounted on TH35/7,5 (mm)		50
Height mounted on TH35/15 (mm)		57
Insulation material temperature index (EN 60216-1) (°C)		130
Plastic material		polyamide UL94V-0



CONNECTION DIAGRAM DISTRIBUTOR TERMINAL BLOCKS HMR.16/GR A HMR.16/D/GR

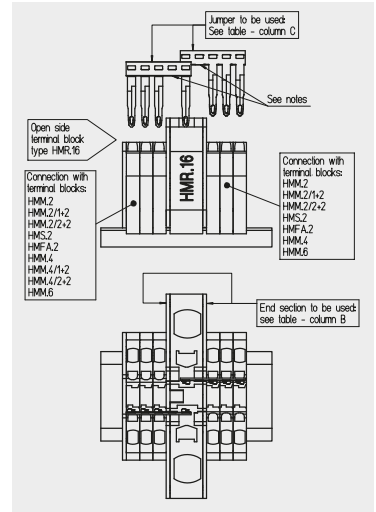

Connection on 2 sides

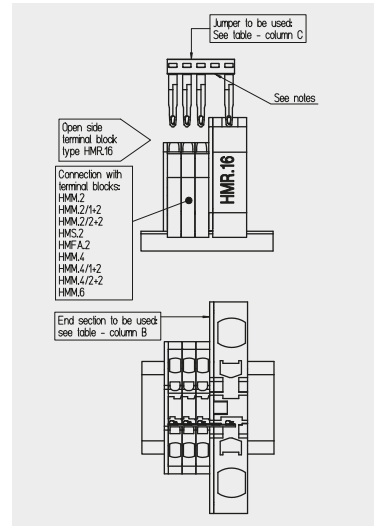

Connection on open sides

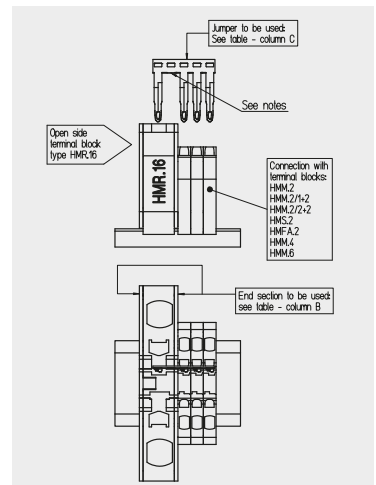

Connection on closed side of distributor

APPROVALS

ACCESSORIES

End section	Thickness (mm)	see table
Cross connection	PTC version [2] (3)	see table
	PTP version [2] (3)	see table
	Rated current (A)	see table
Cross-connection identification strip (100 mm)		-
Coloured partition	red	DFH/4/R (cod. DH04R)
Cross connection barrier	red	-
Test plug		SDD/1 (cod. DD001)
Modular test plug		-
Numbering strip		-
Screwdriver for activation of the spring		CCH/6 (cod. CCH06)
Marking tag		CNU/8/51 (cod. NU0851S)
End bracket	Snap-fit TH35 and G32	BTU (cod. BT005)
	Snap-fit TH35	BTO (cod. BT007)
	Screw TH35	BT/3 (cod. BT003)

TERMINAL BLOCK CONNECTED TO THE DISTRIBUTOR	HMM.2/GR	HMM.4/GR	HMM.6/GR
	HMM.2/1+2/GR	HMM.4/1+2/GR	-
	HMM.2/2+2/GR	HMM.4/2+2/GR	-
	HMS.2/GR	-	-
	HMFA.2/GR	-	-
End section	HMR.16-2/PT/GR (cod. HM352GR)	HMR.16-4/PT/GR (cod. HM354GR)	HMR.16-6/PT/GR (cod. HM356GR)
Thickness (mm)	1.5	1.5	1.5
Permanent cross connection PTC	PTC/03/... (cod. PTC03...)	PTC/05/... (cod. PTC05...)	PTC/08/... (cod. PTC08...)
Permanent cross connection PTP	PTP/03/... (cod. PTP03...)	PTP/05/... (cod. PTP05...)	-
Total current carrying capacity (A)	24	32	41



INERIS 16 ATEX 9002 U
I M2 Ex e I Mb
II 2 G Ex E IIC Gb

IECEX I NE 16.0032U
Ex e I Mb
Ex e IIC Gb

(1) See chapter accessories for more details

YELLOW/GREEN VERSION		CODE	HT400	HT410	HT420
		TYPE	HTE.1	HTE.1/1+2	HTE.1/2+2
TECHNICAL CHARACTERISTICS					
Function/type			earth	earth	earth
Rated cross-section		(mm ²)	1.5	1.5	1.5
Connecting capacity	Flexible	(mm ²)	0.2-2.5	0.2-2.5	0.2-2.5
	Rigid	(mm ²)	0.2-2.5	0.2-2.5	0.2-2.5
	Max. flexible with ferrule - ferrule type	(mm ²)	1.5-WP15/14	1.5-WP15/14	1.5-WP15/14
Electrical characteristics According to European standard IEC EN 60947-7-2	Max AC/DC Voltage	(V)	-	-	-
	Max current with rated cross-section	(A)	-	-	-
	Section	Caliber	B2	B2	B2
Electrical characteristics According to UL	Max AC/DC Voltage	(V)	600	600	600
	Max current with rated cross-section	(A)	-	-	-
	Section Min - Max	(AWG)	26-14	26-14	26-14
Electrical characteristics According to ATEX directive and IEC ex standard	Max AC/DC voltage	(V)	400	400	400
	Max current with rated cross-section	(A)	17.5	17.5	17.5
	Operating temperature	(°C)	-40 +80	-40 +80	-40 +80
Rated impulse withstand voltage/pollution degree			8 KV / 3	8 KV / 3	8 KV / 3
Insulation stripping length		(mm)	10	10	10
Width		(mm)	50	61	65
Length		(mm)	4.2	4.2	4.2
Height mounted on TH35/7.5		(mm)	43	43	43
Height mounted on TH35/15		(mm)	51	51	51
Insulation material temperature index (EN 60216-1)		(°C)	130	130	130
Plastic material			polyamide UL94V-0	polyamide UL94V-0	polyamide UL94V-0
APPROVALS					
ACCESSORIES					
End section	Grey		HMT.1/PT/GR (cod. HM401GR)	HMT.1/1+2/PT/GR (cod. HM411GR)	HMT.1/2+2/PT/GR (cod. HM421GR)
	Blue		-	-	-
Cross connection	Thickness	(mm)	1.5	1.5	1.5
	PTC version [1]		PTC/1/... (cod. PTC01...)	PTC/1/... (cod. PTC01...)	PTC/1/... (cod. PTC01...)
	PTP version [1]		-	-	-
Cross-connection identification strip	Rated current	(A)	17.5	17.5	17.5
	green		PTC/SP (cod. PTC0990)	PTC/SP (cod. PTC0990)	PTC/SP (cod. PTC0990)
Coloured partition	red		DFH/1/R (cod. DH01R)	DFH/2/R (cod. DH02R)	DFH/3/R (cod. DH03R)
Cross connection barrier	red		DFM/500 (cod. DF500)	DFM/500 (cod. DF500)	DFM/500 (cod. DF500)
Test plug			-	-	-
Modular test plug			-	-	-
End section for modular test plug			-	-	-
Numbering strip			SHZ/1 (cod. SH004)	SHZ/1 (cod. SH004)	SHZ/1 (cod. SH004)
Screwdriver for activation of the spring			CCH/2.5-4 (cod. CCH02)	CCH/2.5-4 (cod. CCH02)	CCH/2.5-4 (cod. CCH02)
Marking tag			SHZ/1 (cod. SH004)	SHZ/1 (cod. SH004)	SHZ/1 (cod. SH004)
End bracket	Snap-fit TH35 and G32		BTU (cod. BT005)	BTU (cod. BT005)	BTU (cod. BT005)
	Snap-fit TH35		BTO (cod. BT007)	BTO (cod. BT007)	BTO (cod. BT007)
	Screw TH35		BT/3 (cod. BT003)	BT/3 (cod. BT003)	BT/3 (cod. BT003)



INERIS 16 ATEX 9002 U
I M2 Ex e I Mb
II 2 G Ex E IIC Gb

IECEx I NE 16.0032U
Ex e I Mb
Ex e IIC Gb

(1) See chapter accessories for more details

YELLOW/GREEN VERSION		CODE	HT500	HT510	HT520
		TYPE	HTE.2	HTE.2/1+2	HTE.2/2+2
TECHNICAL CHARACTERISTICS					
Function/type			earth	earth	earth
Rated cross-section		(mm ²)	2.5	2.5	2.5
Connecting capacity	Flexible	(mm ²)	0.2-4	0.2-4	0.2-4
	Rigid	(mm ²)	0.2-4	0.2-4	0.2-4
	Max. flexible with ferrule - ferrule type	(mm ²)	2.5-WP25/14	2.5-WP25/14	2.5-WP25/14
Electrical characteristics According to European standard IEC EN 60947-7-2	Max AC/DC Voltage	(V)	-	-	-
	Max current with rated cross-section	(A)	-	-	-
	Section	Caliber	A3	A3	A3
Electrical characteristics According to UL	Max AC/DC Voltage	(V)	600	600	600
	Max current with rated cross-section	(A)	-	-	-
	Section Min - Max	(AWG)	24-12	24-12	24-12
Electrical characteristics According to ATEX directive and IEC ex standard	Max AC/DC voltage	(V)	500	500	500
	Max current with rated cross-section	(A)	24	24	24
	Operating temperature	(°C)	-40 +80	-40 +80	-40 +80
Rated impulse withstand voltage/pollution degree			8 KV / 3	8 KV / 3	8 KV / 3
Insulation stripping length		(mm)	10	10	10
Width		(mm)	54	70	82
Length		(mm)	5.2	5.2	5.2
Height mounted on TH35/7.5		(mm)	41	41	41
Height mounted on TH35/15		(mm)	49	49	49
Insulation material temperature index (EN 60216-1)		(°C)	130	130	130
Plastic material			polyamide UL94V-0	polyamide UL94V-0	polyamide UL94V-0
APPROVALS					
ACCESSORIES					
End section	Grey		HMT.2/PT/GR (cod. HM501GR)	HMT.2/1+2/PT/GR (cod. HM511GR)	HMT.2/2+2/PT/GR (cod. HM521GR)
	Blue		-	-	-
	Thickness	(mm)	1.5	1.5	1.5
Cross connection	PTC version [1]		PTC/03/... (cod. PTC03...)	PTC/03/... (cod. PTC03...)	PTC/03/... (cod. PTC03...)
	PTP version [1]		PTP/03/... (cod. PTP03...)	PTP/03/... (cod. PTP03...)	PTP/03/... (cod. PTP03...)
	Rated current	(A)	24	24	24
Cross-connection identification strip	green		PTC/SP (cod. PTC0990)	PTC/SP (cod. PTC0990)	PTC/SP (cod. PTC0990)
Coloured partition	red		DFH/1/R (cod. DH01R)	DFH/2/R (cod. DH02R)	DFH/3/R (cod. DH03R)
Cross connection barrier	red		-	-	-
Test plug			SDD/1 (cod. DD001)	SDD/1 (cod. DD001)	SDD/1 (cod. DD001)
Modular test plug			-	-	-
End section for modular test plug			-	-	-
Numbering strip			CNU/8/51 (cod. NU0851S)	CNU/8/51 (cod. NU0851S)	CNU/8/51 (cod. NU0851S)
Screwdriver for activation of the spring			CCH/2.5-4 (cod. CCH02)	CCH/2.5-4 (cod. CCH02)	CCH/2.5-4 (cod. CCH02)
			CNU/8/51 (cod. NU0851S)	CNU/8/51 (cod. NU0851S)	CNU/8/51 (cod. NU0851S)
Marking tag			-	-	-
End bracket	Snap-fit TH35 and G32		BTU (cod. BT005)	BTU (cod. BT005)	BTU (cod. BT005)
	Snap-fit TH35		BTO (cod. BT007)	BTO (cod. BT007)	BTO (cod. BT007)
	Screw TH35		BT/3 (cod. BT003)	BT/3 (cod. BT003)	BT/3 (cod. BT003)



INERIS 16 ATEX 9002 U
I M2 Ex e I Mb
II 2 G Ex E IIC Gb

IECEx I NE 16.0032U
Ex e I Mb
Ex e IIC Gb

(1) See chapter accessories for more details

YELLOW/GREEN VERSION		CODE	HT250	HT260	HT270
		TYPE	HTE.4	HTE.4/1+2	HTE.4/2+2
TECHNICAL CHARACTERISTICS					
Function/type			earth	earth	earth
Rated cross-section		(mm ²)	4	4	4
Connecting capacity	Flexible	(mm ²)	0.2-6	0.2-6	0.2-6
	Rigid	(mm ²)	0.2-6	0.2-6	0.2-6
	Max. flexible with ferrule - ferrule type	(mm ²)	4-WP40/16	4-WP40/16	4-WP40/16
Electrical characteristics According to European standard IEC EN 60947-7-2	Max AC/DC Voltage	(V)	-	-	-
	Max current with rated cross-section	(A)	-	-	-
	Section	Caliber	A4	A4	A4
Electrical characteristics According to UL	Max AC/DC Voltage	(V)	600	600	600
	Max current with rated cross-section	(A)	-	-	-
	Section Min - Max	(AWG)	24-10	24-10	24-10
Electrical characteristics According to ATEX directive and IEC ex standard	Max AC/DC voltage	(V)	500	500	500
	Max current with rated cross-section	(A)	32	32	32
	Operating temperature	(°C)	-40 +80	-40 +80	-40 +80
Rated impulse withstand voltage/pollution degree			8 KV / 3	8 KV / 3	8 KV / 3
Insulation stripping length		(mm)	12	12	12
Width		(mm)	58	78	98
Length		(mm)	6.2	6.2	6.2
Height mounted on TH35/7.5		(mm)	45	45	45
Height mounted on TH35/15		(mm)	52	52	52
Insulation material temperature index (EN 60216-1)		(°C)	130	130	130
Plastic material			polyamide UL94V-0	polyamide UL94V-0	polyamide UL94V-0
APPROVALS					
ACCESSORIES					
End section	Grey		HMT.4/PT/GR (cod. HM251GR)	HMT.4/1+2/PT/GR (cod. HM211GR)	HMT.4/2+2/PT/GR (cod. HM221GR)
	Blue		-	-	-
Cross connection	Thickness	(mm)	1.5	1.5	1.5
	PTC version (1)		PTC/5/... (cod. PTC05...)	PTC/5/... (cod. PTC05...)	PTC/5/... (cod. PTC05...)
	PTP version (1)		PTP/5/... (cod. PTP05...)	PTP/5/... (cod. PTP05...)	PTP/5/... (cod. PTP05...)
Cross-connection identification strip	Rated current	(A)	32	32	32
	green		PTC/SP (cod. PTC0990)	PTC/SP (cod. PTC0990)	PTC/SP (cod. PTC0990)
Coloured partition	red		DFH/1/R (cod. DH01R)	DFH/1/R (cod. DH01R)	DFH/1/R (cod. DH01R)
Cross connection barrier	red		-	-	-
Test plug			SDD/1 (cod. DD001)	SDD/1 (cod. DD001)	SDD/1 (cod. DD001)
Modular test plug			-	-	-
End section for modular test plug			-	-	-
Numbering strip			CNU/8/61 (cod. NU0861S)	CNU/8/61 (cod. NU0861S)	CNU/8/61 (cod. NU0861S)
Screwdriver for activation of the spring			CCH/2.5-4 (cod. CCH02)	CCH/2.5-4 (cod. CCH02)	CCH/2.5-4 (cod. CCH02)
Marking tag			CNU/8/61 (cod. NU0861S)	CNU/8/61 (cod. NU0861S)	CNU/8/61 (cod. NU0861S)
			-	-	-
			-	-	-
End bracket	Snap-fit TH35 and G32		BTU (cod. BT005)	BTU (cod. BT005)	BTU (cod. BT005)
	Snap-fit TH35		BTO (cod. BT007)	BTO (cod. BT007)	BTO (cod. BT007)
	Screw TH35		BT/3 (cod. BT003)	BT/3 (cod. BT003)	BT/3 (cod. BT003)

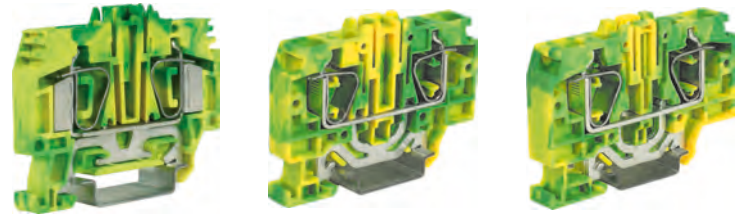

INERIS 16 ATEX 9002 U
I M2 Ex e I Mb
II 2 G Ex E IIC Gb

IECEx I NE 16.0032U
Ex e I Mb
Ex e IIC Gb

(1) See chapter accessories for more details

YELLOW/GREEN VERSION		CODE	HT320	HT330	HT340
		TYPE	HTE.6	HTE.10	HTE.16
TECHNICAL CHARACTERISTICS					
Function/type			earth	earth	earth
Rated cross-section		(mm ²)	6	10	16
Connecting capacity	Flexible	(mm ²)	0.2-10	1.5-16	1.5-25
	Rigid	(mm ²)	0.2-10	1.5-16	1.5-25
	Max. flexible with ferrule - ferrule type	(mm ²)	6-WP60/20	10-WP100/21	16-WP160/22
Electrical characteristics According to European standard IEC EN 60947-7-2	Max AC/DC Voltage	(V)	-	-	-
	Max current with rated cross-section	(A)	-	-	-
	Section	Caliber	A5	A6	A7
Electrical characteristics According to UL	Max AC/DC Voltage	(V)	600	600	600
	Max current with rated cross-section	(A)	-	-	-
	Section Min - Max	(AWG)	24-8	20-6	18-4
Electrical characteristics According to ATEX directive and IEC ex standard	Max AC/DC voltage	(V)	500	500	630
	Max current with rated cross-section	(A)	41	57	76
	Operating temperature	(°C)	-40 +80	-40 +80	-40 +80
Rated impulse withstand voltage/pollution degree			8 KV / 3	12 KV / 3	12 KV / 3
Insulation stripping length		(mm)	13	18	18
Width		(mm)	62	71/70	80
Length		(mm)	8.2	10	12
Height mounted on TH35/7.5		(mm)	44	44	56
Height mounted on TH35/15		(mm)	52	52	64
Insulation material temperature index (EN 60216-1)		(°C)	130	130	130
Plastic material			polyamide UL94V-0	polyamide UL94V-0	polyamide UL94V-0
APPROVALS					
ACCESSORIES					
End section	Grey		HMT.6/PT/GR (cod. HM321GR)	HMT.10/PT (cod. HM331GR)	HMT.16/PT (cod. HM341GR)
	Blue		-	-	-
	Thickness	(mm)	1.5	1.5	1.5
Cross connection	PTC version [1]		PTC/8/... (cod.PTC08...)	PTC/11/... (cod. PTC11...)	PTC/16/... (cod. PTC16...)
	PTP version [1]		-	-	-
	Rated current	(A)	41	57	76
Cross-connection identification strip	green		PTC/SP (cod.PTC0990)	-	-
Coloured partition	red		DFH/1/R (cod. DH01R)	DFH/4/R (cod. DH04R)	DFH/4/R (cod. DH04R)
Cross connection barrier	red		-	-	-
Test plug			SDD/1 (cod. DD001)	SDD/1 (cod. DD001)	SDD/1 (cod. DD001)
Modular test plug			-	-	-
End section for modular test plug			-	-	-
Numbering strip			-	-	-
Screwdriver for activation of the spring			CCH/6 (cod. CCH06)	CCH/6 (cod. CCH06)	CCH/6 (cod. CCH06)
Marking tag			CNU/8/51 (cod. NU0851S)	CNU/8/51 (cod. NU0851S)	CNU/8/51 (cod. NU0851S)
End bracket	Snap-fit TH35 and G32		BTU (cod. BT005)	BTU (cod. BT005)	BTU (cod. BT005)
	Snap-fit TH35		BTO (cod. BT007)	BTO (cod. BT007)	BTO (cod. BT007)
	Screw TH35		BT/3 (cod. BT003)	BT/3 (cod. BT003)	BT/3 (cod. BT003)



INERIS 16 ATEX 9002 U
I M2 Ex e I Mb
II 2 G Ex e IIC Gb

IECEX I NE 16.0032U
Ex e I Mb
Ex e IIC Gb

(1) See chapter accessories for more details



GREY VERSION	CODE	HD200GR	HMD.1/GR	HD120GR	HMD.1/CI/GR
	TYPE	HMD.1 (GR)		HMD.1/CI/GR	
BLUE VERSION	CODE	HD300			
	TYPE	HMD.1 (EX)I			

TECHNICAL CHARACTERISTICS

Function/type		two-level feed-through	two-levels and internal connection
Rated cross-section	(mm ²)	1.5	1.5
Connecting capacity	Flexible (mm ²)	0.2-2.5	0.2-2.5
	Rigid (mm ²)	0.2-2.5	0.2-2.5
	Max. flexible with ferrule - ferrule type (mm ²)	1.5-WP15/14	1.5-WP15/14
Electrical characteristics According to European standard IEC EN 60947-7-1	Max AC/DC Voltage (V)	500	500
	Max current with rated cross-section (A)	17.5	17.5
	Section (Caliber)	B2	B2
Electrical characteristics According to UL	Max AC/DC Voltage (V)	600	600
	Max current with rated cross-section (A)	15	15
	Section Min - Max (AWG)	26-14	26-14
Electrical characteristics According to ATEX directive and IEC ex standard	Max AC/DC voltage (V)	400	400
	Max current with rated cross-section (A)	24	24
	Operating temperature (°C)	-40 +80	-40 +80
Rated impulse withstand voltage/pollution degree		6 KV / 3	6 KV / 3
Insulation stripping length (mm)		10	10
Width (mm)		73	73
Length (mm)		4.2	4.2
Height mounted on TH35/7.5 (mm)		59	59
Height mounted on TH35/15 (mm)		67	67
Insulation material temperature index (EN 60216-1) (°C)		130	130
Plastic material		polyamide UL94V-0	polyamide UL94V-0

APPROVALS

ACCESSORIES

End section	Grey	HMD.1/PT/GR (cod. HD201GR)	HMD.1/PT/GR (cod. HD201GR)
	Blue	HMD.1/PT (Ex)I (cod. HD301)	HMD.1/PT (Ex)I (cod. HD301)
	Thickness (mm)	1.5	1.5
Cross connection	PTC version (1)	PTC/1/... (cod. PTC01...)	PTC/1/... (cod. PTC01...)
	PTP version (1)	-	-
Cross-connection identification strip	Rated current (A)	17.5	17.5
	green	PTC/SP (cod. PTC0990)	PTC/SP (cod. PTC0990)
Internal cross connection (removable)		-	-
Coloured partition	red	DFU/07/R (cod. DU07R)	DFU/07/R (cod. DU07R)
Cross connection barrier	red	DFM/500 (cod. DF500)	DFM/500 (cod. DF500)
Test plug		-	-
Modular test plug		SDH/4 (cod. DH004)	SDH/4 (cod. DH004)
End section for modular test plug		SH4/PT (cod. DH401)	SH4/PT (cod. DH401)
Numbering strip		SHZ/1 (cod. SH004)	SHZ/1 (cod. SH004)
Screwdriver for activation of the spring		CCH/2.5-4 (cod. CCH02)	CCH/2.5-4 (cod. CCH02)
Marking tag		SHZ/1 (cod. SH004)	SHZ/1 (cod. SH004)
		-	-
End bracket	Snap-fit TH35 and G32	BTU (cod. BT005)	BTU (cod. BT005)
	Snap-fit TH35	BTO (cod. BT007)	BTO (cod. BT007)
	Screw TH35	BT/3 (cod. BT003)	BT/3 (cod. BT003)





INERIS 16 ATEX 9002 U
I M2 Ex e I Mb
II 2 G Ex e IIC Gb

IECEX I NE 16.0032U
Ex e I Mb
Ex e IIC Gb

(1) See chapter accessories for more details



GREY VERSION	CODE	HD400GR	HD450GR
	TYPE	HMD.2N/GR	HMD.2N/CI/GR
BLUE VERSION		CODE	
	TYPE	HD410	
		HMD.2N (EX)I	

TECHNICAL CHARACTERISTICS

Function/type		HD400GR	HD450GR
		two-level feed-through	two-levels and internal connection
Rated cross-section	(mm ²)	2.5	2.5
Connecting capacity	Flexible (mm ²)	0.2-2.5	0.2-2.5
	Rigid (mm ²)	0.2-2.5	0.2-2.5
	Max. flexible with ferrule - ferrule type (mm ²)	1.5-WP15/14	1.5-WP15/14
Electrical characteristics According to European standard IEC EN 60947-7-1	Max AC/DC Voltage (V)	630	630
	Max current with rated cross-section (A)	24	24
	Section (Caliber)	B2	B2
Electrical characteristics According to UL	Max AC/DC Voltage (V)	600	600
	Max current with rated cross-section (A)	15	15
	Section Min - Max (AWG)	26-14	26-14
Electrical characteristics According to ATEX directive and IEC ex standard	Max AC/DC voltage (V)	400	400
	Max current with rated cross-section (A)	24	24
	Operating temperature (°C)	-40 +80	-40 +80
Rated impulse withstand voltage/pollution degree		8 KV / 3	8 KV / 3
Insulation stripping length (mm)		10	10
Width (mm)		73	73
Length (mm)		5.2	5.2
Height mounted on TH35/7.5 (mm)		59	59
Height mounted on TH35/15 (mm)		67	67
Insulation material temperature index (EN 60216-1) (°C)		130	130
Plastic material		polyamide UL94V-0	polyamide UL94V-0

APPROVALS

ACCESSORIES

End section	Grey	HMD.1/PT/GR (cod. HD201GR)	HMD.1/PT/GR (cod. HD201GR)
	Blue	HMD.1/PT (Ex)I (cod. HD301)	HMD.1/PT (Ex)I (cod. HD301)
	Thickness (mm)	1.5	1.5
Cross connection	PTC version (1)	PTC/03/... (cod. PTC03...)	PTC/03/... (cod. PTC03...)
	PTP version (1)	PTP/03/... (cod. PTP03...)	PTP/03/... (cod. PTP03...)
	Rated current (A)	24	24
Cross-connection identification strip	green	-	-
Internal cross connection (removable)		-	-
Coloured partition	red	DFU/07/R (cod. DU07R)	DFU/07/R (cod. DU07R)
Cross connection barrier	red	DFM/500 (cod. DF500)	DFM/500 (cod. DF500)
Test plug		-	-
Modular test plug		SDH/7 (cod. DH007)	SDH/7 (cod. DH007)
End section for modular test plug		SH7/PT (cod. DH701)	SH7/PT (cod. DH701)
Numbering strip		CNU/8/51 (cod. NU0851S)	CNU/8/51 (cod. NU0851S)
Screwdriver for activation of the spring		CCH/2.5-4 (cod. CCH02)	CCH/2.5-4 (cod. CCH02)
Marking tag		CNU/8/51 (cod. NU0851S)	CNU/8/51 (cod. NU0851S)
		-	-
End bracket	Snap-fit TH35 and G32	BTU (cod. BT005)	BTU (cod. BT005)
	Snap-fit TH35	BTO (cod. BT007)	BTO (cod. BT007)
	Screw TH35	BT/3 (cod. BT003)	BT/3 (cod. BT003)



SPRING CLAMP



INERIS 16 ATEX 9002 U
I M2 Ex e I Mb
II 2 G Ex e IIC Gb

IECEX I NE 16.0032U
Ex e I Mb
Ex e IIC Gb

[1] See chapter accessories for more details

GREY VERSION	CODE	HD100GR
	TYPE	HMD.2/GR
BLUE VERSION	CODE	
	TYPE	

TECHNICAL CHARACTERISTICS

Function/type		two-level feed-through
Rated cross-section	(mm ²)	2.5
Connecting capacity	Flexible (mm ²)	0.2-4
	Rigid (mm ²)	0.2-4
	Max. flexible with ferrule - ferrule type (mm ²)	1.5-WP15/14
Electrical characteristics According to European standard IEC EN 60947-7-1	Max AC/DC Voltage (V)	630
	Max current with rated cross-section (A)	24
	Section (Caliber)	A3
Electrical characteristics According to UL	Max AC/DC Voltage (V)	600
	Max current with rated cross-section (A)	20
	Section Min - Max (AWG)	24-12
Electrical characteristics According to ATEX directive and IEC ex standard	Max AC/DC voltage (V)	400
	Max current with rated cross-section (A)	24
	Operating temperature (°C)	-40 +80
Rated impulse withstand voltage/pollution degree		8 KV / 3
Insulation stripping length	(mm)	10
Width	(mm)	91
Length	(mm)	5.2
Height mounted on TH35/7.5	(mm)	49
Height mounted on TH35/15	(mm)	56
Insulation material temperature index (EN 60216-1)	(°C)	130
Plastic material		polyamide UL94V-0

APPROVALS



ACCESSORIES

End section	Grey	HMD/PT/GR (cod. HD101GR)
	Blue	-
	Thickness (mm)	1.5
Cross connection	PTC version [1]	PH/2.5-4 (cod. PH100)
	PTP version [1]	PHD/2 (cod. PHD02)
	Rated current (A)	24
Cross-connection identification strip	green	-
Internal cross connection (removable)		PHD/2 (cod. PHD02)
Coloured partition	red	DFH/4/R (cod. DH04R)
Cross connection barrier	red	
Test plug		-
Modular test plug		-
End section for modular test plug		-
Numbering strip		CNU/8/51 (cod. NU0851S)
Screwdriver for activation of the spring		CCH/2.5-4 (cod. CCH02)
Marking tag		CNU/8/51 (cod. NU0851S)(only lower level)
		-
End bracket	Snap-fit TH35 and G32	BTU (cod. BT005)
	Snap-fit TH35	BTO (cod. BT007)
	Screw TH35	BT/3 (cod. BT003)

- versions made ready for housing electronic components



[1] See chapter accessories for more details

GREY VERSION	CODE	HD130GR	HD440GR	HD441GR
BLUE VERSION	TYPE	HMD.1/X/GR	HMD.2N/X/GR	HMD.2N/X1/GR

TECHNICAL CHARACTERISTICS

Function/type		two level, arranged to contain electronic components	two level, arranged to contain electronic components	two-level, upper feed-through and lower disconnect
Rated cross-section	(mm ²)	1.5	2.5	2.5
Connecting capacity	Flexible	0.2-2.5	0.2-2.5	0.2-2.5
	Rigid	0.2-2.5	0.2-2.5	0.2-2.5
	Max. flexible with ferrule - ferrule type	1.5-WP15/14	1.5-WP15/14	1.5-WP15/14
Electrical characteristics According to European standard IEC EN 60947-7-1	Max AC/DC Voltage	500	630	630
	Max current with rated cross-section	16	24	24
	Section	B2	B2	B2
Electrical characteristics According to UL	Max AC/DC Voltage	600	-	-
	Max current with rated cross-section	15	-	-
	Section Min - Max	26-14	-	-
Electrical characteristics According to ATEX directive and IEC ex standard	Max AC/DC voltage	-	-	-
	Max current with rated cross-section	-	-	-
	Operating temperature	°C	-	-
Rated impulse withstand voltage/pollution degree		6 KV / 3	6 KV / 3	8 KV / 3
Insulation stripping length	(mm)	10	10	10
Width	(mm)	73	73	73
Length	(mm)	4.2	5.2	5.2
Height mounted on TH35/7.5	(mm)	59	59	59
Height mounted on TH35/15	(mm)	67	67	67
Insulation material temperature index (EN 60216-1)	(°C)	130	130	130
Plastic material		polyamide UL94V-0	polyamide UL94V-0	polyamide UL94V-0



APPROVALS

ACCESSORIES

End section	Grey	HMD.1/PT/GR (cod. HD201GR)	HMD.1/PT/GR (cod. HD201GR)	HMD.1/PT/GR (cod. HD201GR)	
	Blue	-	-	-	
	Thickness	(mm)	1.5	1.5	1.5
Cross connection	PTC version [1]	PTC/1/... (cod. PTC01...)	PTC/03/... (cod. PTC03...)	PTC/03/... (cod. PTC03...)	
	PTP version [1]	-	-	-	
Cross-connection identification strip	Rated current	(A)	17.5	24	24
	green	PTC/SP (cod. PTC0990)	-	-	
Internal cross connection (removable)		-	-	-	
Coloured partition	red	DFU/07/R (cod. DU07R)	DFU/07/R (cod. DU07R)	DFU/07/R (cod. DU07R)	
Cross connection barrier	red	DFM/500 (cod. DF500)	DFM/500 (cod. DF500)	DFM/500 (cod. DF500)	
Test plug		-	-	-	
Modular test plug		SDH/4 (cod. DH004)	SDH/7 (cod. DH007)	SDH/7 (cod. DH007)	
End section for modular test plug		SH4/PT (cod. DH401)	SH7/PT (cod. DH701)	SH7/PT (cod. DH701)	
Numbering strip		SHZ/1 (cod. SH004)	CNU/8/51 (cod. NU0851S)	CNU/8/51 (cod. NU0851S)	
Screwdriver for activation of the spring		CCH/2.5-4 (cod. CCH02)	CCH/2.5-4 (cod. CCH02)	CCH/2.5-4 (cod. CCH02)	
Marking tag		SHZ/1 (cod. SH004)	CNU/8/51 (cod. NU0851S)	CNU/8/51 (cod. NU0851S)	
		-	-	-	
		-	-	-	
End bracket	Snap-fit TH35 and G32	BTU (cod. BT005)	BTU (cod. BT005)	BTU (cod. BT005)	
	Snap-fit TH35	BTO (cod. BT007)	BTO (cod. BT007)	BTO (cod. BT007)	
	Screw TH35	BT/3 (cod. BT003)	BT/3 (cod. BT003)	BT/3 (cod. BT003)	

- Versions made ready for housing electronic components and modular test plug



[1] See chapter accessories for more details

GREY VERSION	CODE	HD420GR	HD430GR
	TYPE	HMD.2N/DD/GR	HMD.2/3DC/GR
BLUE VERSION	CODE		
	TYPE		

TECHNICAL CHARACTERISTICS

Function/type		version equipped with two 1N4007 diodes in feed-through configuration for each level	version equipped with three 1N4007 diodes and shared cathode
Rated cross-section	(mm ²)	2.5	2.5
Connecting capacity	Flexible (mm ²)	0.2-2.5	0.2-2.5
	Rigid (mm ²)	0.2-2.5	0.2-2.5
	Max. flexible with ferrule - ferrule type (mm ²)	1.5-WP15/14	1.5-WP15/14
Electrical characteristics According to European standard IEC EN 60947-7-1	Max AC/DC Voltage (V)	630	630
	Max current with rated cross-section (A)	24	24
	Section (Caliber)	B2	B2
Electrical characteristics According to UL	Max AC/DC Voltage (V)	-	-
	Max current with rated cross-section (A)	-	-
	Section Min - Max (AWG)	-	-
Electrical characteristics According to ATEX directive and IEC ex standard	Max AC/DC voltage (V)	-	-
	Max current with rated cross-section (A)	-	-
	Operating temperature (°C)	-	-
Rated impulse withstand voltage/pollution degree		6 KV / 3	6 KV / 3
Insulation stripping length (mm)		10	10
Width (mm)		73	73
Length (mm)		5.2	5.2
Height mounted on TH35/7.5 (mm)		59	59
Height mounted on TH35/15 (mm)		67	67
Insulation material temperature index (EN 60216-1) (°C)		130	130
Plastic material		polyamide UL94V-0	polyamide UL94V-0

APPROVALS



ACCESSORIES

End section	Grey	HMD.1/PT/GR (cod. HD201GR)	HMD.1/PT/GR (cod. HD201GR)
	Blue	-	-
	Thickness (mm)	1.5	1.5
Cross connection	PTC version [1]	PTC/03/... (cod. PTC03...)	PTC/03/... (cod. PTC03...)
	PTP version [1]	-	-
	Rated current (A)	24	24
Cross-connection identification strip	green	-	-
Internal cross connection (removable)		-	-
Coloured partition	red	DFU/07/R (cod. DU07R)	DFU/07/R (cod. DU07R)
Cross connection barrier	red	DFM/500 (cod. DF500)	DFM/500 (cod. DF500)
Test plug		-	-
Modular test plug		SDH/7 (cod. DH007)	SDH/7 (cod. DH007)
End section for modular test plug		SH7/PT (cod. DH701)	SH7/PT (cod. DH701)
Numbering strip		CNU/8/51 (cod. NU0851S)	CNU/8/51 (cod. NU0851S)
Screwdriver for activation of the spring		CCH/2.5-4 (cod. CCH02)	CCH/2.5-4 (cod. CCH02)
Marking tag		CNU/8/51 (cod. NU0851S)	CNU/8/51 (cod. NU0851S)
		-	-
End bracket	Snap-fit TH35 and G32	BTU (cod. BT005)	BTU (cod. BT005)
	Snap-fit TH35	BTO (cod. BT007)	BTO (cod. BT007)
	Screw TH35	BT/3 (cod. BT003)	BT/3 (cod. BT003)



INERIS 16 ATEX 9002 U
I M2 Ex e I Mb
II 2 G Ex e IIC Gb

IECEX I NE 16.0032U
Ex e I Mb
Ex e IIC Gb

(1) See chapter accessories for more details



GREY VERSION	CODE	HL200GR	HL210GR	HL500GR
	TYPE	HLD.2/GR	HLD.2/CI/GR	HDE.2/GR
BLUE VERSION	CODE	HD510		
	TYPE	HLD.2 (EX)I		

TECHNICAL CHARACTERISTICS

Function/type		3 levels	3 levels with internal connection	2 levels + earth
Rated cross-section	(mm ²)	2,5	2,5	2,5
Connecting capacity	Flexible (mm ²)	0.2-2.5	0.2-2.5	0.2-2.5
	Rigid (mm ²)	0.2-2.5	0.2-2.5	0.2-2.5
	Max. flexible with ferrule - ferrule type (mm ²)	1.5-WP15/14	1.5-WP15/14	1.5-WP15/14
Electrical characteristics According to European standard IEC EN 60947-7-1	Max AC/DC Voltage (V)	500	500	500
	Max current with rated cross-section (A)	24	24	24
	Section (Caliber)	B2	B2	B2
Electrical characteristics According to UL	Max AC/DC Voltage (V)	-	-	-
	Max current with rated cross-section (A)	-	-	-
	Section Min - Max (AWG)	-	-	-
Electrical characteristics According to ATEX directive and IEC ex standard	Max AC/DC voltage (V)	400	400	400
	Max current with rated cross-section (A)	24	24	24
	Operating temperature (°C)	-40 +80	-40 +80	-40 +80
Rated impulse withstand voltage/pollution degree		8 KV / 3	8 KV / 3	8 KV / 3
Insulation stripping length (mm)		10	10	10
Width (mm)		95	95	95
Length (mm)		5.2	5.2	5.2
Height mounted on TH35/7.5 (mm)		75	75	75
Height mounted on TH35/15 (mm)		83	83	83
Insulation material temperature index (EN 60216-1) (°C)		130	130	130
Plastic material		polyamide UL94V-0	polyamide UL94V-0	polyamide UL94V-0

APPROVALS

ACCESSORIES

End section	Grey	HLD.2/PT/GR (cod. HL201GR)	HLD.2/PT/GR (cod. HL201GR)	HLD.2/PT/GR (cod. HL201GR)
	Blue	-	-	-
	Thickness (mm)	1.5	1.5	1.5
Cross connection	PTC version (1)	PTC/03/... (cod. PTC03...)	PTC/03/... (cod. PTC03...)	PTC/03/... (cod. PTC03...)
	PTP version (1)	PTP/03/... (cod. PTP03...)	PTP/03/... (cod. PTP03...)	PTP/03/... (cod. PTP03...)
	Rated current (A)	24	24	24
Cross-connection identification strip	green	-	-	-
Internal cross connection (removable)		-	-	-
Coloured partition	red	-	-	-
Cross connection barrier	red	DFM/500 (cod. DF500)	DFM/500 (cod. DF500)	DFM/500 (cod. DF500)
Test plug		-	-	-
Modular test plug		-	-	-
End section for modular test plug		-	-	-
Numbering strip		CNU/8/51 (cod. NU0851S)	CNU/8/51 (cod. NU0851S)	CNU/8/51 (cod. NU0851S)
Screwdriver for activation of the spring		CCH/2.5-4 (cod. CCH02)	CCH/2.5-4 (cod. CCH02)	CCH/2.5-4 (cod. CCH02)
Marking tag		CNU/8/51 (cod. NU0851S)	CNU/8/51 (cod. NU0851S)	CNU/8/51 (cod. NU0851S)
		-	-	-
End bracket	Snap-fit TH35 and G32	BTU (cod. BT005)	BTU (cod. BT005)	BTU (cod. BT005)
	Snap-fit TH35	BTO (cod. BT007)	BTO (cod. BT007)	BTO (cod. BT007)
	Screw TH35	BT/3 (cod. BT003)	BT/3 (cod. BT003)	BT/3 (cod. BT003)

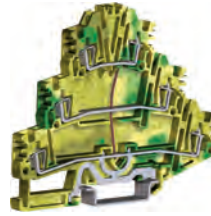

INERIS 16 ATEX 9002 U
I M2 Ex e I Mb
II 2 G Ex e IIC Gb

IECEX I NE 16.0032U
Ex e I Mb
Ex e IIC Gb

[1] See chapter accessories for more details

YELLOW/GREEN VERSION

CODE
TYPE

HLT500

HTTE.2

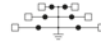

TECHNICAL CHARACTERISTICS

Function/type		3 levels + earth
Rated cross-section	(mm ²)	2.5
Connecting capacity	Flexible (mm ²)	0.2-2.5
	Rigid (mm ²)	0.2-2.5
	Max. flexible with ferrule - ferrule type (mm ²)	1.5-WP15/14
Electrical characteristics According to European standard IEC EN 60947-7-2	Max AC/DC Voltage (V)	-
	Max current with rated cross-section (A)	-
	Section Caliber	B2
Electrical characteristics According to UL	Max AC/DC Voltage (V)	-
	Max current with rated cross-section (A)	-
	Section Min - Max (AWG)	-
Electrical characteristics According to ATEX directive and IEC ex standard	Max AC/DC voltage (V)	400
	Max current with rated cross-section (A)	24
	Operating temperature (°C)	-40 +80
Rated impulse withstand voltage/pollution degree		8 KV / 3
Insulation stripping length (mm)		10
Width (mm)		95
Length (mm)		5.2
Height mounted on TH35/7.5 (mm)		75
Height mounted on TH35/15 (mm)		83
Insulation material temperature index (EN 60216-1) (°C)		130
Plastic material		polyamide UL94V-0

APPROVALS



ACCESSORIES

End section	Grey	HLT.2/PT/GR (cod. HL2016R)
	Blue	-
	Thickness (mm)	1.5
Cross connection	PTC version [1]	PTC/03/... (cod. PTC03...)
	PTP version [1]	PTP/03/... (cod. PTP03...)
	Rated current (A)	24
Cross-connection identification strip	green	-
Internal cross connection (removable)		-
Coloured partition	red	-
Cross connection barrier	red	DFM/500 (cod. DF500)
Test plug		-
Modular test plug		-
End section for modular test plug		-
Numbering strip		CNU/8/51 (cod. NU0851S)
Screwdriver for activation of the spring		CCH/2.5-4 (cod. CCH02)
Marking tag		CNU/8/51 (cod. NU0851S)
		-
End bracket	Snap-fit TH35 and G32	BTU (cod. BT005)
	Snap-fit TH35	BTO (cod. BT007)
	Screw TH35	BT/3 (cod. BT003)

- disconnect by lever and by slide link
- for test and measurement circuits

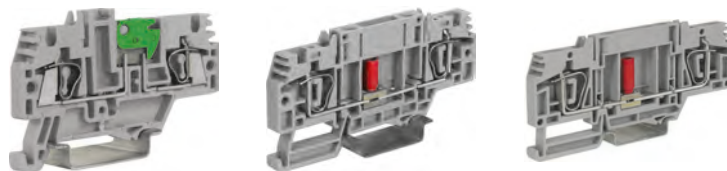

[1] See chapter accessories for more details

GREY VERSION		CODE TYPE	HS200GR HMS.2/GR	HB100GR HSCB.4/GR	HB200GR HSCB.6/GR
TECHNICAL CHARACTERISTICS					
Function/type			disconnect by lever	disconnect by slide link	disconnect by slide link
Rated cross-section		(mm ²)	2.5	4	6
Connecting capacity	Flexible	(mm ²)	0.2-4	0.2-6	0.2-10
	Rigid	(mm ²)	0.2-4	0.2-6	0.2-10
	Max. flexible with ferrule - ferrule type	(mm ²)	2.5-WP25/14	4-WP40/16	6-WP60/20
Electrical characteristics According to European standard IEC EN 60947-7-1	Max AC/DC Voltage	(V)	400	800	800
	Max current with rated cross-section	(A)	16	32	41
	Section	Caliber	A3	A4	A5
Electrical characteristics According to UL	Max AC/DC Voltage	(V)	600	600	600
	Max current with rated cross-section	(A)	24	30	35
	Section Min - Max	(AWG)	24-12	28-10	24-8
Rated impulse withstand voltage/pollution degree			6 KV / 3	6 KV / 3	6 KV / 3
Insulation stripping length		(mm)	10	12	13
Width		(mm)	66	86	97
Length		(mm)	5.2	6.2	8.2
Height mounted on TH35/7.5		(mm)	37	45	48
Height mounted on TH35/15		(mm)	45	53	56
Insulation material temperature index (EN 60216-1)		(°C)	130	130	130
Plastic material			polyamide UL94V-0	polyamide UL94V-0	polyamide UL94V-0
APPROVALS					
ACCESSORIES					
End section	Grey		HMT.2/1+2/PT/GR (cod. HM511GR)	HSCB.4/PT/GR (cod. HB101GR)	HSCB.6/PT/GR (cod. HB201GR)
	Blue		-	-	-
	Thickness	(mm)	1.5	1.5	1.5
Cross connection	PTC version [1]		PTC/03/... (cod. PTC03...)	PTC/05/... (cod. PTC05...)	PTC/8/... (cod. PTC08...)
	PTP version [1]		PTP/03/... (cod. PTP03...)	PTP/05/... (cod. PTP05...)	-
	Rated current	(A)	24	32	41
Cross-connection identification strip	green		-	PTC/SP (cod. PTC0990)	PTC/SP (cod. PTC0990)
Coloured partition	red		DFH/2/R (cod. DH02R)	DFH/4/R (cod. DH04R)	-
Cross connection barrier	red		-	-	DFM/500 (cod. DF500)
Test plug			SDD/1 (cod. DD001)	-	SDD/1 (cod. DD001)
Modular test plug			SDH/5 (cod. DH005)	SDH/6 (cod. DH006)	-
End section for modular test plug			SH5/PT (cod. DH501)	SH6/PT (cod. DH601)	-
Numbering strip			CNU/8/51 (cod. NU0851)	-	-
Screwdriver for activation of the spring			CCH/2.5-4 (cod. CCH02)	CCH/2.5-4 (cod. CCH02)	CCH/6 (cod. CCH06)
Screw and sleeve for short-circuit plates (with socket)			-	HSCB/4/CPM (cod. HB405)	HSCB/6/CPM (cod. HB205)
Short-circuit plate	2 poles		-	HSCB/4/PO/2 (cod. HB403)	HSCB/6/PO/2 (cod. HB203)
	4 poles		-	HSCB/4/PO/4 (cod. HB404)	HSCB/6/PO/4 (cod. HB204)
Marking tag			-	CNU/8/51 (cod. NU0851S)	CNU/8/51 (cod. NU0851S)
End bracket	Snap-fit TH35 and G32		BTU (cod. BT005)	BTU (cod. BT005)	BTU (cod. BT005)
	Snap-fit TH35		BTO (cod. BT007)	BTO (cod. BT007)	BTO (cod. BT007)
	Screw TH35		BT/3 (cod. BT003)	BT/3 (cod. BT003)	BT/3 (cod. BT003)

- for “blade” fuse according to DIN 72581/3F – ISO 8820 and for Ø 5 x 20 mm fuses (all supplied separately)
- modular with component-holder cartridge CPF05, this one should be provided empty or already composed with electronic circuits (for more details see accessories chapter)



[1] See chapter accessories for more details

GREY VERSION		CODE	HF300GR
		TYPE	HMFA.2/GR
TECHNICAL CHARACTERISTICS			
Function/type		for blade fuse and component-holder cartridge	
Rated cross-section	(mm ²)	2.5	
Connecting capacity	Flexible (mm ²)	0.2-4	
	Rigid (mm ²)	0.2-4	
	Max. flexible with ferrule - ferrule type (mm ²)	2.5-WP25/14	
Electrical characteristics According to European standard IEC EN 60947-7-1	Max AC/DC Voltage (V)	400	
	Max current with rated cross-section (A)	6.3	
	Section Caliber	A3	
Electrical characteristics According to UL	Max AC/DC Voltage (V)	-	
	Max current with rated cross-section (A)	-	
	Section Min-Max (AWG)	-	
Rated impulse withstand voltage/pollution degree		4 KV / 3	
Insulation stripping length	(mm)	10	
Width	(mm)	66	
Length	(mm)	5.2	
Height mounted on TH35/7,5	(mm)	41	
Height mounted on TH35/15	(mm)	49	
Insulation material temperature index (EN 60216-1)	(°C)	130	
Plastic material		polyamide UL94V-0	
APPROVALS			
ACCESSORIES			
End section	Grey	HMT.2/1+2/PT/GR [cod. HM511GR]	
	Blue	-	
	Thickness (mm)	1.5	
Cross connection	PTC version [1]	PTC/03/... [cod. PTC03...]	
	PTP version [1]	PTP/03/... [cod. PTP03...]	
	Rated current (A)	24	
Cross connection identification strip	[100mm]	-	
Coloured partition	Red	DFH/2/R [cod. DH02R]	
Cross connection barrier	Red		
Test plug		SDD/1 [cod. DD001]	
Modular test plug		SDH/5 [cod. DH005]	
End section for modular test plug		SH5/PT [cod. DH501]	
Screwdriver for activation of the spring		CCH/2.5-4 [cod. CCH02]	
Component-holder cartridge	[1]	CPF/5 [CPF05]	
Blade-type fuses according to DIN 72581/3F ISO 8820 max voltage 32 V In = 2 A, 5A, 7.5A, 15A		F32/... [cod. FN032...]	
Numbering strip		CNU/8/51 [cod. NU0851S]	
Marking tag		CNU/8/51 [cod. NU0851S]	
End bracket	Snap-fit TH35	BTU [cod. BT005]	
	Snap-fit TH35	BTO [cod. BT007]	
	Snap TH35	BT/3 [cod. BT003]	

MAX. DISSIPATED POWER IN CONF. WITH IEC 60947-7-3				
Terminal block	MPFA.4 + CPF/5	DSFA.4 + CPF/5	HMFA.2 + CPF/5	
Voltage (V)	250	250	250	
Current (A)	6.3	6.3	6.3	
Protection against overload and short circuit	Single configuration (PV) - (W)	1.6	1.6	1.6
	Composite configuration (PV) - (W)	1.6	1.6	1.6
Only protection against short circuit	Single configuration (PVK) - (W)	4	4	4
	Composite configuration (PVK) - (W)	1.6	1.6	1.6

- for $\varnothing 5 \times 20$ mm or $\varnothing 6.3 \times 32$ mm fuses (supplied separately), with possible warning of any broken fuse through LED microcircuit (CIL/...) or [only HFR.4/GR] neon light (LSN)
- available in grey (RAL 7042)
- can be coupled with all HMM.4/... terminal blocks

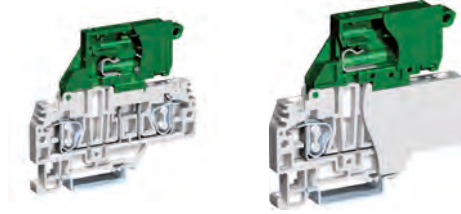

[1] See chapter accessories for more details

GREY VERSION		CODE TYPE	HF310GR HFR.4/M/GR	HF210GR HFR.4/GR
TECHNICAL CHARACTERISTICS				
Function/type			for $\varnothing 5 \times 20$ mm fuse	for $\varnothing 6.3 \times 32$ mm fuse
Rated cross-section		(mm ²)	4	4
Connecting capacity	Flexible	(mm ²)	0.2-6	0.2-6
	Rigid	(mm ²)	0.2-6	0.2-6
	Max. flexible with ferrule - ferrule type	(mm ²)	4-WP40/16	4-WP40/16
Electrical characteristics According to European standard IEC EN 60947-7-1	Max AC/DC Voltage	(V)	500	500
	Max current with rated cross-section	(A)	6.3 A (10 A with CO/5)	10
	Section	Caliber	A4	A4
Electrical characteristics According to UL	Max AC/DC Voltage	(V)	600	600
	Max current with rated cross-section	(A)	10	15
	Section Min-Max	(AWG)	28 - 10	28 - 10
Rated impulse withstand voltage/pollution degree			4 KV / 3	4 KV / 3
Insulation stripping length		(mm)	12	12
Width		(mm)	78	78
Length		(mm)	6.2	8.2
Height mounted on TH35/7,5		(mm)	70	70
Height mounted on TH35/15		(mm)	78	78
Insulation material temperature index (EN 60216-1)		(°C)	130	130
Plastic material			polyamide UL94V-0	polyamide UL94V-0
APPROVALS				
ACCESSORIES				
End section	Grey		HFR.4/PT/GR (cod. HF211GR)	-
	Blue		-	-
	Thickness	(mm)	1.5	-
Cross connection	PTC version [1]		PTC/5/... (cod. PTC05...)	PTC/51/... (cod. PTC51...)
	PTP version [1]		-	-
	Rated current	(A)	32	32
Cross connection identification strip		(100mm)	PTC/SP (cod. PTC0990)	PTC/SP (cod. PTC0990)
Coloured partition		Red	DFH/4/R (cod. DH04R)	DFH/4/R (cod. DH04R)
Cross connection barrier		Red	-	-
Test plug			SDD/1 (cod. DD001)	SDD/1 (cod. DD001)
Miniature fuse		$\varnothing 5 \times 20$ mm	F5/... (cod. FN...)	-
Conductive element		$\varnothing 5 \times 20$ mm	CO/5 (cod. VL103)	-
Neon lamp		$\varnothing 6 \times 26$ mm	-	LSN (cod. FL202)
Warning circuit			CIL/HFR/M/12-48 (cod. HF518M)	CIL/HFR/12-48 (cod. HF518)
Warning circuit			CIL/HFR/M/115-230 (cod. HF510M)	CIL/HFR/115-230 (cod. HF510)
Terminal block with 12-48 V non-polarized LED circuit			HFR.4/M/GR/C12-48 (cod. HF918MGR)	HFR.4/GR/C115-230 (cod. HF910GR)
Terminal block with 115-230 V non-polarized LED circuit			HFR.4/M/GR/C115-230 (cod. HF910MGR)	HFR.4/M/GR/C115-230 (cod. HF910MGR)
Numbering strip			CNU/8/61 (cod. NU0861S)	-
Screwdriver for activation of the spring			CCH/2.5-4 (cod. CCH02)	CCH/2.5-4 (cod. CCH02)
Marking tag			CNU/8/51 (cod. NU0851S)	CNU/8/51 (cod. NU0851S)
			CNU/8/51 (cod. NU1051S)	CNU/8/51 (cod. NU1051S)
			-	-
End bracket	Snap-fit TH35		BTU (cod. BT005)	BTU (cod. BT005)
	Snap-fit TH35		BTO (cod. BT007)	BTO (cod. BT007)
	Snap TH35		BT/3 (cod. BT003)	BT/3 (cod. BT003)

- for female connectors pitch 5.08 mm – on two levels



[1] See chapter accessories for more details

GREY VERSION	CODE	HC200GR
	TYPE	HCD.1/GR
BLUE VERSION	CODE	HC210
	TYPE	HCD.1 (EX)I

TECHNICAL CHARACTERISTICS

Function/type	2 level feed-through with 2 screw connections and 2 pins for connectors	
Rated cross-section	(mm ²)	1.5
Connecting capacity	Flexible (mm ²)	0.2–2.5
	Rigid (mm ²)	0.2–2.5
	Max. flexible with ferrule - ferrule type (mm ²)	1.5–WP15/14
Electrical characteristics According to European standard IEC EN 60947-7-1	Max AC/DC Voltage (V)	320
	Max current with rated cross-section (A)	12
	Section Caliber	B2
Electrical characteristics According to UL	Max AC/DC Voltage (V)	300
	Max current with rated cross-section (A)	12
	Section Min-Max (AWG)	26 - 14
Rated impulse withstand voltage/pollution degree		6 KV / 3
Insulation stripping length	(mm)	10
Width	(mm)	72
Length	(mm)	5.08
Height mounted on TH35/7,5	(mm)	59
Height mounted on TH35/15	(mm)	67
Insulation material temperature index (EN 60216-1)	(°C)	130
Plastic material		polyamide UL94V-0



APPROVALS



ACCESSORIES

End section	Grey	HCD.1/PT/GR (cod. HC201GR)
	Blue	HCD.1/PT(Ex)i (cod. HC211)
	Thickness (mm)	1.5
Cross connection	PTC version [1]	PTC/2/... (cod. PTC02...)
	PTP version [1]	-
	Rated current (A)	24
Cross connection identification strip	(100mm)	-
Coloured partition	Red	DFU/7/R (cod. DU07R)
Cross connection barrier	Red	DFM/500 (cod. DF500)
Test plug		-
Modular test plug		-
End section for modular test plug		-
Protection cover for 10-pole shanks		VPC/VT (cod. VP102)
Numbering strip		CNU/8/51 (cod. NU0851S)
Screwdriver for activation of the spring		CCH/2.5-4 (cod. CCH02)
Marking tag		CNU/8/51 (cod. NU0851S)
Marking tag		CNU/10/51 (cod. NU1051S)
End bracket	Snap-fit TH35	BT0 (cod. BT007)
End bracket	Screw TH35	BT/3 (cod. BT003)

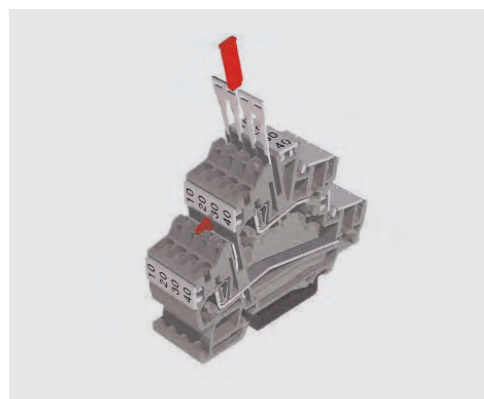

Detail of PTC jumper with DFM/500 barriers, CNU/8/51 numbering strips and VPC/VT lug protection covers

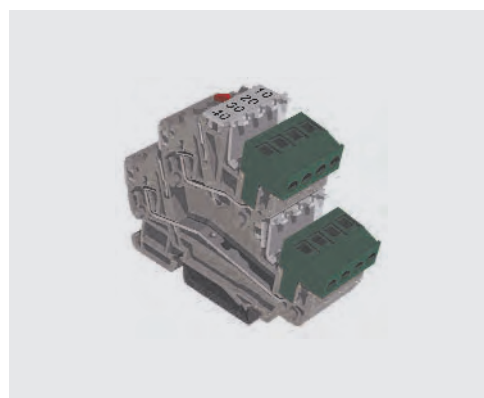

Detail with 5.08 mm female connectors inserted on the two levels and the lug protection covers raised

Female connectors, 90°–5.08 mm pitch and with a number of poles from 2 to 16, are available. The connector can be easily inserted until it reaches its blocking position, guaranteeing optimum connection onto the male contact. In this position the connector is hooked onto the insulating body with the holding tooth with which it is fitted.

VPC/F02	2 poles	Cat. No.	VP902
VPC/F03	3 poles	Cat. No.	VP903
VPC/F04	4 poles	Cat. No.	VP904
VPC/F05	5 poles	Cat. No.	VP905
VPC/F06	6 poles	Cat. No.	VP906
VPC/F07	7 poles	Cat. No.	VP907
VPC/F08	8 poles	Cat. No.	VP908
VPC/F09	9 poles	Cat. No.	VP909
VPC/F10	10 poles	Cat. No.	VP910
VPC/F11	11 poles	Cat. No.	VP911
VPC/F12	12 poles	Cat. No.	VP912
VPC/F13	13 poles	Cat. No.	VP913
VPC/F14	14 poles	Cat. No.	VP914
VPC/F15	15 poles	Cat. No.	VP915
VPC/F16	16 poles	Cat. No.	VP916

- spring system with connector plug



(1) See chapter accessories for more details
(2) dimensions with inserted connector

GREY VERSION	CODE	HVP300GR	HVP900GR	HVP910GR
	TYPE	HVPC.2/GR	CHP.2/GR	CHP.2D/GR
BLUE VERSION	CODE	HVP305	HVP905	HVP915
	TYPE	HVPC.2 (EX)I	CHP.2 (EX)I	CHP.2D (EX)I

TECHNICAL CHARACTERISTICS

Function/type		feed trough for connectors	female connector for one conductor	female connector for two conductors
Rated cross-section	(mm ²)	2.5	2.5	2.5
Connecting capacity	Flexible (mm ²)	0.2-4	0.2-4	0.2-4
	Rigid (mm ²)	0.2-4	0.2-4	0.2-4
	Max. flexible with ferrule - ferrule type (mm ²)	2.5-WP25/14	2.5-WP25/14	2.5-WP25/14
Electrical characteristics According to European standard IEC EN 60947-7-1	Max AC/DC Voltage (V)	800	500	500
	Max current with rated cross-section (A)	24	24	24
	Section Caliber	A3	A3	A3
Electrical characteristics According to UL	Max AC/DC Voltage (V)	-	-	-
	Max current with rated cross-section (A)	-	-	-
	Section Min-Max (AWG)	-	-	-
Electrical characteristics According to ATEX directive and IEC ex standard	Max AC/DC Voltage (V)	-	-	-
	Max current with rated cross-section (A)	-	-	-
	Operating temperature (°C)	-	-	-
Rated impulse withstand voltage/pollution degree		8 KV / 3	8 KV / 3	8 KV / 3
Insulation stripping length	(mm)	10	10	10
Width	(mm)	50	58 [2]	58 [2]
Length	(mm)	5.2	5.2	5.2
Height mounted on TH35/7,5	(mm)	41	67 [2]	67 [2]
Height mounted on TH35/15	(mm)	49	75 [2]	75 [2]
Insulation material temperature index (EN 60216-1)	(°C)	130	130	130
Plastic material		polyamide UL94V-0	polyamide UL94V-0	polyamide UL94V-0

APPROVALS



ACCESSORIES

End section	Grey	HVPC.2/PT/GR (cod. HVP301GR)	CHP.2/PT/GR (cod. HVP901GR)	CHP.2D/PT/GR (cod. HVP911GR)
	Blue	-	-	-
	Thickness (mm)	1.5	1.5	1.5
Cross connection	PTC version (1)	PTC/03/... (cod. PTC03...)	PTC/03/... (cod. PTC03...)	PTC/03/... (cod. PTC03...)
	PTP version (1)	PTP/03/... (cod. PTC03...)	PTP/03/... (cod. PTC03...)	PTP/03/... (cod. PTC03...)
	Rated current (A)	24	24	24
Cross connection identification strip	(100mm) Green	PTC/SP (cod. PTC0990)	PTC/SP (cod. PTC0990)	PTC/SP (cod. PTC0990)
Coloured partition	Red	DFH/1/R (cod. DH01R)	DFH/1/R (cod. DH01R)	DFH/1/R (cod. DH01R)
Cross connection barrier	Red	-	-	-
Test plug		SDD/1 (cod. DD001)	SDD/1 (cod. DD001)	SDD/1 (cod. DD001)
Modular test plug		SDH/5 (cod. DH005)	SDH/5 (cod. DH005)	SDH/5 (cod. DH005)
End section for modular test plug		SH5/PT (cod. DH501)	SH5/PT (cod. DH501)	SH5/PT (cod. DH501)
Screwdriver for activation of the spring		CCH/2.5-4 (cod. CCH02)	CCH/2.5-4 (cod. CCH02)	CCH/2.5-4 (cod. CCH02)
Numbering strip		CNU/8/51 (cod. NU0851S)	CNU/8/51 (cod. NU0851S)	CNU/8/51 (cod. NU0851S)
Marking tag		CNU/8/51 (cod. NU0851S)	CNU/8/51 (cod. NU0851S)	CNU/8/51 (cod. NU0851S)
Marking tag		CNU/10/51 (cod. NU1051S)	CNU/10/51 (cod. NU1051S)	CNU/10/51 (cod. NU1051S)
End bracket	Snap-fit TH35 and G32	BTU (cod. BT005)	-	-
End bracket	Snap-fit TH35	BTO (cod. BT007)	-	-
End bracket	Screw TH35	BT/3 (cod. BT003)	-	-

- spring system with connector plug for earth connections



(1) See chapter accessories for more details
(2) dimensions with inserted connector

YELLOW/GREEN VERSION		CODE TYPE	HVT500 HVTE.2	HVT900 CHTE.2	HVT910 CHTE.2D
TECHNICAL CHARACTERISTICS					
Function/type			earth type for connectors	female connector for one conductor	female connector for two conductors
Rated cross-section		(mm ²)	2.5	2.5	2.5
Connecting capacity	Flexible	(mm ²)	0.2-4	0.2-4	0.2-4
	Rigid	(mm ²)	0.2-4	0.2-4	0.2-4
	Max. flexible with ferrule - ferrule type	(mm ²)	2.5-WP25/14	2.5-WP25/14	2.5-WP25/14
Electrical characteristics According to European standard IEC EN 60947-7-2	Max AC/DC Voltage	(V)	-	-	-
	Max current with rated cross-section	(A)	-	-	-
	Section	Caliber	A3	A3	A3
Electrical characteristics According to UL	Max AC/DC Voltage	(V)	600	600	600
	Max current with rated cross-section	(A)	-	-	-
	Section Min-Max	(AWG)	28-12	28-12	28-12
Electrical characteristics According to ATEX directive and IEC ex standard	Max AC/DC Voltage	(V)	-	-	-
	Max current with rated cross-section	(A)	-	-	-
	Operating temperature	(°C)	-	-	-
Rated impulse withstand voltage/pollution degree			8 KV / 3	8 KV / 3	8 KV / 3
Insulation stripping length		(mm)	10	10	10
Width		(mm)	50	58 [2]	58 [2]
Length		(mm)	5.2	5.2	5.2
Height mounted on TH35/7,5		(mm)	41	67 [2]	67 [2]
Height mounted on TH35/15		(mm)	49	75 [2]	75 [2]
Insulation material temperature index (EN 60216-1)		(°C)	130	130	130
Plastic material			polyamide UL94V-0	polyamide UL94V-0	polyamide UL94V-0

APPROVALS



ACCESSORIES			HVT500	HVT900	HVT910
End section	Grey		HVPC.2/PT/GR (cod. HVP301GR)	CHP.2/PT/GR (cod. HVP901GR)	CHP.2D/PT/GR (cod. HVP911GR)
	Blue		-	-	-
	Thickness	(mm)	1.5	1.5	1.5
Cross connection	PTC version [1]		PTC/03/... (cod. PTC03...)	PTC/03/... (cod. PTC03...)	PTC/03/... (cod. PTC03...)
	PTP version [1]		PTP/03/... (cod. PTC03...)	PTP/03/... (cod. PTC03...)	PTP/03/... (cod. PTC03...)
	Rated current	(A)	24	24	24
Cross connection identification strip		(100mm) Green	PTC/SP (cod. PTC0990)	PTC/SP (cod. PTC0990)	PTC/SP (cod. PTC0990)
Coloured partition		Red	DFH/1/R (cod. DH01R)	DFH/1/R (cod. DH01R)	DFH/1/R (cod. DH01R)
Cross connection barrier		Red	-	-	-
Test plug			SDD/1 (cod. DD001)	SDD/1 (cod. DD001)	SDD/1 (cod. DD001)
Modular test plug			SDH/5 (cod. DH005)	SDH/5 (cod. DH005)	SDH/5 (cod. DH005)
End section for modular test plug			SH5/PT (cod. DH501)	SH5/PT (cod. DH501)	SH5/PT (cod. DH501)
Screwdriver for activation of the spring			CCH/2.5-4 (cod. CCH02)	CCH/2.5-4 (cod. CCH02)	CCH/2.5-4 (cod. CCH02)
Numbering strip			CNU/8/51 (cod. NU0851S)	CNU/8/51 (cod. NU0851S)	CNU/8/51 (cod. NU0851S)
Marking tag			CNU/8/51 (cod. NU0851S)	CNU/8/51 (cod. NU0851S)	CNU/8/51 (cod. NU0851S)
Marking tag			CNU/10/51 (cod. NU1051S)	CNU/10/51 (cod. NU1051S)	CNU/10/51 (cod. NU1051S)
End bracket		Snap-fit TH35 and G32	BTU (cod. BT005)	-	-
End bracket		Snap-fit TH35	BTO (cod. BT007)	-	-
End bracket		Screw TH35	BT/3 (cod. BT003)	-	-

- space saving
- mounting only on PR/2 TH/15

	INERIS 16 ATEX 9002 U	IECEX INE 16.0032U
	I M2 Ex e I Mb	Ex e I Mb
	II 2 G Ex E IIC Gb	Ex e IIC Gb

[1] See chapter accessories for more details

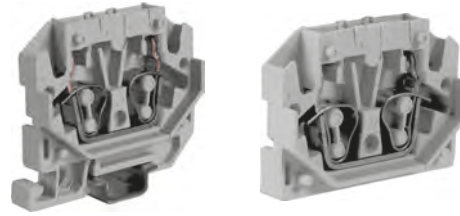

GREY VERSION	CODE	HP170GR	HP150GR
	TYPE	HPP.2/GR	HP.2/GR
BLUE VERSION	CODE	HI132	HI130
	TYPE	HPP.2 (EX)II	HP.2 (EX)II

TECHNICAL CHARACTERISTICS

Function/type		feed-through	feed-through
Rated cross-section	(mm ²)	2.5	2.5
Connecting capacity	Flexible (mm ²)	0.2-4	0.2-4
	Rigid (mm ²)	0.2-4	0.2-4
	Max. flexible with ferrule - ferrule type (mm ²)	2.5-WP25/14	2.5-WP25/14
Electrical characteristics According to European standard IEC EN 60947-7-1	Max AC/DC Voltage (V)	800	800
	Max current with rated cross-section (A)	24	24
	Section Caliber	A3	A3
Electrical characteristics According to UL	Max AC/DC Voltage (V)	600	600
	Max current with rated cross-section (A)	20 / 24	20 / 24
	Section Min-Max (AWG)	28-12	28-12
Electrical characteristics According to ATEX directive and IEC ex standard	Max AC/DC Voltage (V)	630	630
	Max current with rated cross-section (A)	24	24
	Operating temperature (°C)	-40 +80	-40 +80
Rated impulse withstand voltage/pollution degree		8 KV / 3	8 KV / 3
Insulation stripping length (mm)		10	10
Width (mm)		36	36
Length (mm)		5.2	5.2
Height mounted on TH35/7,5 (mm)		35	30
Insulation material temperature index (EN 60216-1) (°C)		130	130
Plastic material		polyamide UL94V-0	polyamide UL94V-0

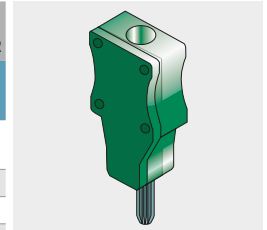

Modular test plug

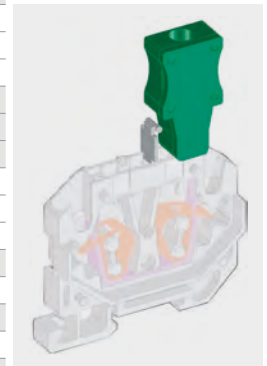

In electrical panels where the spaces are particularly limited and in any case when a high wiring density is required, Cabur proposes, also for the connection with spring technology, a series of mini terminal blocks, for conductors up to 4 mm². The range comprises three versions, for panel mounting (fixing with screw or clip) and for mounting on 15 mm PR/2 guide, according to IEC 60715. The particular conformation of the insulating body of the three types of terminal blocks enables snap-in coupling of each of them, including between terminal blocks of different types, in order to ensure the maximum flexibility of use.

SUGGESTED COMPOSITION: for mounting terminal boards made up of **HPP.2/GR** terminal blocks a conformation of the terminal board of four **HP.2/GR** for every **HPP.2/GR** is recommended. If instead it is necessary to remove the terminal board thus made up from the guide, it is recommended to separate units made up of a **HPP.2/GR** and remove one at a time, with the aid of an opportune screwdriver [CCH/2,5-4], acting in the specific slots.

APPROVALS



ACCESSORIES

End section	Grey	HP/PT/GR (cod. HP101GR)	HPV/PT/GR (cod. HV111GR)
	Blue	-	-
Cross connection	Thickness (mm)	1.5	1.5
	PTC version [1]	PTC/03/... (cod. PTC03...)	PTC/03/... (cod. PTC03...)
	PTP version [1]	-	-
Cross connection identification strip	Rated current (A)	24	24
	green	PTC/SP (cod. PTC0990)	PTC/SP (cod. PTC0990)
Coloured partition	Red	DFP/2/R (cod. DFP2R)	DFP/2/R (cod. DFP2R)
Test plug		SDD/1 (cod. DD001)	SDD/1 (cod. DD001)
Modular test plug		SDH/5 (cod. DH005)	SDH/5 (cod. DH005)
End section for modular test plug		SH5/PT (cod. DH501)	SH5/PT (cod. DH501)
Screwdriver for activation of the spring		CCH/2.5-4 (cod. CCH02)	CCH/2.5-4 (cod. CCH02)
Marking tag		SHZ/2 (cod. SH001)	SHZ/2 (cod. SH001)
End bracket	Screw TH35	BT/2 (cod. BT006)	BT/2 (cod. BT006)

- panel mount by means of clips
- fixing hole Ø 3.5 mm
- panel thickness 0.6 – 1.2 mm



	INERIS 16 ATEX 9002 U	IECEX I NE 16.0032U
	I M2 Ex e I Mb	Ex e I Mb
	II 2 G Ex E IIC Gb	Ex e IIC Gb

[1] See chapter accessories for more details

GREY VERSION	CODE	HP160GR
	TYPE	HPC.2/GR
BLUE VERSION	CODE	HI131
	TYPE	HPC.2 (EX)I

TECHNICAL CHARACTERISTICS

Function/type		feed-through
Rated cross-section	(mm ²)	2.5
Connecting capacity	Flexible (mm ²)	0.2-4
	Rigid (mm ²)	0.2-4
	Max. flexible with ferrule - ferrule type (mm ²)	2.5-WP25/14
Electrical characteristics According to European standard IEC EN 60947-7-1	Max AC/DC Voltage (V)	800
	Max current with rated cross-section (A)	24
	Section Caliber	A3
Electrical characteristics According to UL	Max AC/DC Voltage (V)	600
	Max current with rated cross-section (A)	20 / 24
	Section Min-Max (AWG)	28-12
Electrical characteristics According to ATEX directive and IEC ex standard	Max AC/DC Voltage (V)	630
	Max current with rated cross-section (A)	24
	Operating temperature (°C)	-40 +80
Rated impulse withstand voltage/pollution degree		8 KV / 3
Insulation stripping length	(mm)	10
Width	(mm)	36
Length	(mm)	5.2
Height mounted on TH35/7,5	(mm)	30
Insulation material temperature index (EN 60216-1)	(°C)	130
Plastic material		polyamide UL94V-0

APPROVALS

ACCESSORIES

End section	Grey	HPV/PT/GR (cod. HV111GR)
	Blue	-
Thickness	(mm)	1.5
Cross connection	PTC version [1]	PTC/03/... (cod. PTC03...)
	PTP version [1]	-
	Rated current (A)	24
Cross connection identification strip	green	PTC/SP (cod. PTC0990)
Coloured partition	Red	DFP/2/R (cod. DFP2R)
Test plug		SDD/1 (cod. DD001)
Modular test plug		SDH/5 (cod. DH005)
End section for modular test plug		SH5/PT (cod. DH501)
Screwdriver for activation of the spring		CCH/2.5-4 (cod. CCH02)
Marking tag		SHZ/2 (cod. SH001)
End bracket	Screw TH35	BT/2 (cod. BT006)

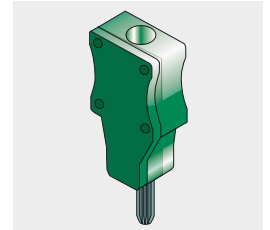

Modular test plug

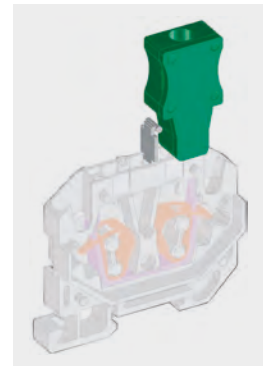

In electrical panels where the spaces are particularly limited and in any case when a high wiring density is required, Cabur proposes, also for the connection with spring technology, a w of mini terminal blocks, for conductors up to 4 mm². The range comprises three versions, for panel mounting (fixing with screw or clip) and for mounting on 15 mm PR/2 guide. The particular conformation of the insulating body of the three types of terminal blocks enables snap-in coupling of each of them, including between terminal blocks of different types, in order to ensure the maximum flexibility of use.

Blank lined area for notes.

Screw-Clamp Terminal Blocks

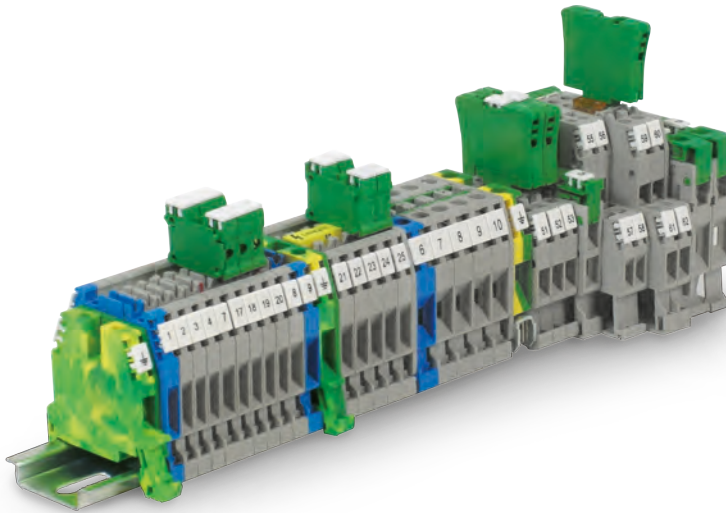

CESI 08 ATEX 061 U
I M2 Ex eb I Mb
II 2 G Ex eb IIC Gb

IECEx CES 09.0002U
Ex eb I Mb
Ex eb IIC Gb

- Reduced overall dimensions
- Mounting on PR/3 rails according IEC 60715, TH/35 type
- Nominal voltage 1000 V
- Maximum continual operating temperature 130°C

- Double possibility of inserting multi-pole PTC cross connections, with no need for additional insulating covers, thanks to the patented "Easy Bridge" (PTC) system and to the new "Easy Bridge Plus" (PTP)
- Available in grey and blue; for other available colours refer to the single versions

Easy Bridge System

The Cross connection can be supplied in "standard" size, for 2-3-5-10 poles, or in 250-mm-long bars. The "Easy Bridge" connection system guarantees the widest possibility of transversal connection, including offset.

The cross connections can also be used to connect in parallel terminal blocks of the same section with the first of the following unit with a different section.

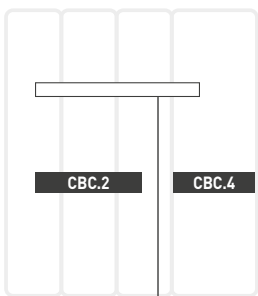
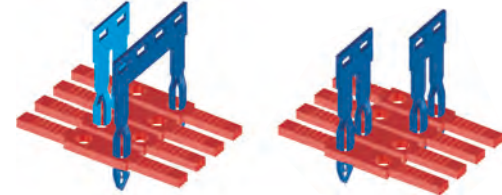

Multi-pole CBC.2 cross-connection

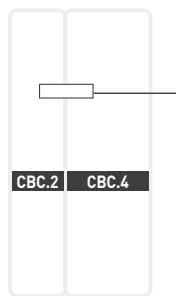

2 pole CBC.2 cross-connection

SDC
mounted

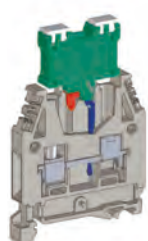

SDC/P
mounted

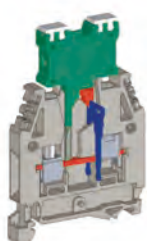

SDC - SDC/P
with conductors

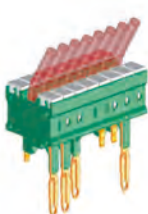

DFM/900



DFM/800

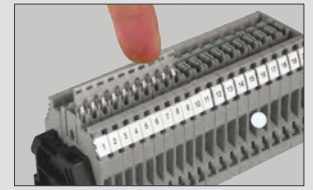

After cutting the bar for the number of poles necessary, insert the cross connection in the special cavity of the terminal block.

At this point working with the tip of a screwdriver, push the cross connection up to the locking point. The cross connection will be completely isolated and intrinsically IPXXB protected.

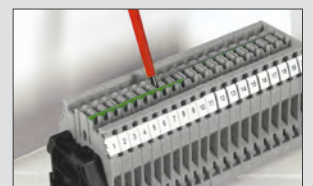

After inserting the cross connection, the poles connected can be highlighted with the aid of the green insert, PTC/SP. This accessory is supplied in the standard length of 100 mm and can easily be sliced with the aid of a simple cutter.



To remove the cross connection it is sufficient to remove the PTC/SP insert, insert the tip of the screwdriver in the slot of the cross connection itself, lever it and pull it out.



CESI 08 ATEX 061 U
I M2 Ex eb I Mb
II 2 G Ex eb IIC Gb

IECEX CES 09.0002U
Ex eb I Mb
Ex eb IIC Gb

(1) See chapter accessories for more details



GREY VERSION	CODE TYPE	CBC02GR	CBC04GR	CBC06GR
		CBC.2/GR	CBC.4/GR	CBC.6/GR
BLUE VERSION	CODE TYPE	CBI02	CBI04	CBI06
		CBC.2 (EX)I	CBC.4 (EX)I	CBC.6 (EX)I

TECHNICAL CHARACTERISTICS

Function/type		feed-through	feed-through	feed-through
Rated cross-section	(mm ²)	2.5	4	6
Connecting capacity	Flexible	0,2 ÷ 4	0,2 ÷ 6	0,2 ÷ 10
	Rigid	0,2 ÷ 4	0,2 ÷ 6	0,2 ÷ 10
	Max.flexible with ferrule - ferrule type	2.5 - WP25 / 14	4 - WP40 / 16	6 - WP60 / 20
Electrical characteristics According to European standard IEC EN 60947-7-1	Max AC/DC Voltage	(V) 1000	1000	1000
	Max current with rated cross-section	(A) 24	32	41
	Max current with Max cross-section	(A) 37	45	64
Electrical characteristics According to UL	Section	Caliber A3	A4	A5
	Max AC/DC Voltage	(V) 600	600	600
	Max current with rated cross-section/Factory wiring only	(A) 20 / 24	30 / 32	50
	Section Min-Max	(AWG) 20-12	20-10	20-8
Electrical characteristics According to ATEX directive and IEC ex standard	Tightening torque	(lb.in) 3.5	4.4	15
	Max AC/DC Voltage	(V) 500	500	500
	Max current with rated cross-section	(A) 24	32	41
Operating temperature	(°C) -40 ÷ +110	-40 ÷ +110	-40 ÷ +110	
Rated impulse withstand voltage/pollution degree		12 KV / 3	12 KV / 3	8 KV / 3
Insulation stripping length	(mm)	9	10	10
Tightening torque nominal/max	(Nm)	0,4 / 0,8	0,5 / 1,2	0,8 / 1,4
Width	(mm)	5	6	8
Length	(mm)	44	44	44
Height mounted on TH35/7,5	(mm)	52	52	52
Height mounted on TH35/15	(mm)	60	60	60
Insulation material temperature index (EN 60216-1)	(°C)	130	130	130
Plastic material		polyamide UL94V-0	polyamide UL94V-0	polyamide UL94V-0

APPROVALS



ACCESSORIES

End section	Grey	CBC.2-10/PT/GR (cod. CB061GR)	CBC.2-10/PT/GR (cod. CB061GR)	CBC.2-10/PT/GR (cod. CB061GR)
	Blue	CBC.2-10/PT (Ex)I (cod. CBI061)	CBC.2-10/PT (Ex)I (cod. CBI061)	CBC.2-10/PT (Ex)I (cod. CBI061)
	Thickness	(mm) 1.5	1.5	1.5
Cross connection	PTC version (1)	PTC/2/... (cod. PTC02...)	PTC/4/... (cod. PTC04...)	PTC/6/... (cod. PTC06...)
	PTP version (1)	PTP/2/... (cod. PTP02...)	PTP/4/... (cod. PTP04...)	PTP/6/... (cod. PTP06...)
	Rated current / Rated current ATEX applications	(A) 24 / 21	32 / 25	41 / 35
Cross connection identification strip	green	PTC/SP (cod. PTC0990)	PTC/SP (cod. PTC0990)	PTC/SP (cod. PTC0990)
Disconnectable parallel bridge		-	-	-
Multiple common bar	250 mm	-	-	-
Shunting screw and sleeve	Standard / Ex e version	-	-	-
Coloured partition	red	DFU/4/R (cod. DU04R)	DFU/4/R (cod. DU04R)	DFU/4/R (cod. DU04R)
Cross connection barrier	red	DFM/800 (cod. DF800) - DFM/900 (cod. DF900)	DFM/800 (cod. DF800) - DFM/900 (cod. DF900)	DFM/800 (cod. DF800) - DFM/900 (cod. DF900)
Test plug socket		-	-	-
Test plug		-	-	-
Polarization insert		SDC/POL (cod. DCPOL)	SDC/POL (cod. DCPOL)	-
Modular test plug		SDC/5 (cod. DC005) - SDC/5P (cod. DC05P)	SDC/6 (cod. DC006) - SDC/6P (cod. DC06P)	-
Numbering strip		CNU/8/61 (cod. NU0861S)	CNU/8/61 (cod. NU0861S)	-
Marking tag		CNU/8/51 (cod. NU0851S)	CNU/8/51 (cod. NU0851S)	CNU/8/51 (cod. NU0851S)
Warning plate	on adjacent terminal blocks	PRP/7/G (cod. PRP070G)	PRP/7/G (cod. PRP070G)	PRP/7/G (cod. PRP070G)
Cover for cross-connection		-	-	-
End bracket	Snap-fit TH35 and G32	BTU (cod. BT005)	BTU (cod. BT005)	BTU (cod. BT005)
	Snap-fit TH35	BTO (cod. BT007)	BTO (cod. BT007)	BTO (cod. BT007)
	Screw TH35	BT/3 (cod. BT003)	BT/3 (cod. BT003)	BT/3 (cod. BT003)



CESI 08 ATEX 061 U
I M2 Ex eb I Mb
II 2 G Ex eb IIC Gb

IECEX CES 09.0002U
Ex eb I Mb
Ex eb IIC Gb

(1) See chapter accessories for more details



GREY VERSION	CODE TYPE	CBC10GR	CBC16GR	CBC35GR
		CBC.10/GR	CBC.16/GR	CBC.35/GR
BLUE VERSION	CODE TYPE	CBI10	CBI16	CBI35
		CBC.10 (EX)I	CBC.16 (EX)I	CBC.35 (EX)I

TECHNICAL CHARACTERISTICS

Function/type		feed-through	feed-through	feed-through
Rated cross-section	(mm ²)	10	16	35
Connecting capacity	Flexible	1,5 ÷ 16	1,5 ÷ 25	2,5 ÷ 50
	Rigid	1,5 ÷ 16	1,5 ÷ 25	2,5 ÷ 50
	Max.flexible with ferrule - ferrule type	10 - WP100 / 21	16 - WP160 / 22	35 - WP350 / 30
Electrical characteristics According to European standard IEC EN 60947-7-1	Max AC/DC Voltage	1000	1000	1000
	Max current with rated cross-section	57	76	101
	Max current with Max cross-section	85	114	160
Electrical characteristics According to UL	Section	Caliber B6	B7	B9
	Max AC/DC Voltage	600	600	600
	Max current with rated cross-section/Factory wiring only	65	100	125
Electrical characteristics According to ATEX directive and IEC ex standard	Section Min-Max	[AWG] 14-6	16-3	12-1
	Tightening torque	(lb.in) 17	25	75
	Max AC/DC Voltage	400	500	630
Rated impulse withstand voltage/pollution degree	Max current with rated cross-section	57	76	125
	Operating temperature	(°C) -40 ÷ +110	-40 ÷ +110	-40 ÷ +110
Insulation stripping length	(mm)	8 KV / 3	12 KV / 3	12 KV / 3
Tightening torque nominal/max	(Nm)	12	15	18
Width	(mm)	1,2 / 1,9	2 / 3	2,5 / 5
Length	(mm)	10	12	16
Height mounted on TH35/7,5	(mm)	44	47	56
Height mounted on TH35/15	(mm)	52	56	63
Insulation material temperature index (EN 60216-1)	(°C)	60	64	71
Plastic material		130	130	130
		polyamide UL94V-0	polyamide UL94V-0	polyamide UL94V-0

APPROVALS



ACCESSORIES

End section	Grey	CBC.2-10/PT/GR (cod. CB061GR)	CBC.16/PT/GR (cod. CB161GR)	CBC.35/PT/GR (cod. CB351GR)
	Blue	CBC.2-10/PT (Ex)I (cod. CBI061)	CBC.16/PT (Ex)I (cod. CBI161)	CBC.35/PT (Ex)I (cod. CBI351)
	Thickness	(mm) 1.5	1.5	1.5
Cross connection	PTC version (1)	PTC/10/... (cod. PTC10...)	POF/53 (cod. POF53) - PFX/53 (cod. PFX53)	POF/53 (cod. POF53) - PFX/53 (cod. PFX53)
	PTP version (1)	PTP/10/... (cod. PTP10...)	-	-
Cross connection identification strip	Rated current / Rated current ATEX applications (A)	57 / 47	76 / 76	125 / 125
Disconnectable parallel bridge	green	PTC/SP (cod. PTC0990)	-	-
Multiple common bar	250 mm	-	POS/53 (cod. POS53)	-
Shunting screw and sleeve	Standard / Ex e version	-	PMP/05 (cod. PMP05) 21 poles	PMP/35 (cod. PMP35) 16 poles
Coloured partition	red	DFU/4/R (cod. DU04R)	CPM/53 (cod. CPM53) - CPX/53 (cod. CPX53)	CPM/53 (cod. CPM53) - CPX/53 (cod. CPX53)
Cross connection barrier	red	DFM/800 (cod. DF800) - DFM/900 (cod. DF900)	DFU/4/R (cod. DU04R)	DFU/5/R (cod. DU05R)
Test plug socket		DFM/700 (cod. DF700)	DFM/700 (cod. DF700)	DFM/700 (cod. DF700)
Test plug		-	PSD/B (cod. PD002)	PSD/B (cod. PD002)
Polarization insert		-	SDD/2 (cod. DD002)	SDD/2 (cod. DD002)
Modular test plug		-	-	-
Numbering strip		-	-	-
Marking tag		CNU/8/51 (cod. NU0851S)	CNU/8/51 (cod. NU0851S)	CNU/8/51 (cod. NU0851S)
Warning plate	on adjacent terminal blocks	PRP/7/G (cod. PRP070G)	TUM/16 (cod. TUM16)	TUM/16 (cod. TUM16)
Cover for cross-connection		-	PRP/7 (cod. PRP07)	PRP/8 (cod. PRP08)
End bracket	Snap-fit TH35 and G32	BTU (cod. BT005)	BTU (cod. BT005)	BTU (cod. BT005)
	Snap-fit TH35	BTO (cod. BT007)	BTO (cod. BT007)	BTO (cod. BT007)
	Screw TH35	BT/3 (cod. BT003)	BT/3 (cod. BT003)	BT/3 (cod. BT003)

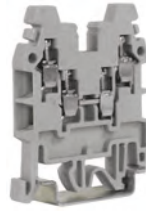

(1) See chapter accessories for more details

GREY VERSION	CODE	CR110GR
	TYPE	CBR.2/GR
BEIGE VERSION	CODE	CR110
	TYPE	CBR.2
BLUE VERSION	CODE	CI110
	TYPE	CBR.2 [EXI]

TECHNICAL CHARACTERISTICS



Function/type		distributor feed-through (2 inputs / 2 outputs)
Rated cross-section	(mm ²)	2.5
Connecting capacity	Flexible (mm ²)	0.2÷4
	Rigid (mm ²)	0.2÷4
	Max.flexible with ferrule - ferrule type (mm ²)	2.5 - WP25/14
Electrical characteristics According to European standard IEC EN 60947-7-1	Max AC/DC Voltage (V)	800
	Max current with rated cross-section (A)	24
	Section Caliber	A3
Electrical characteristics According to UL	Max AC/DC Voltage (V)	600
	Max current with rated cross-section (A)	15
	Section Min-Max (AWG)	20 - 14
	Tightening torque ((lb.in)	5,5
Rated impulse withstand voltage/pollution degree		8kV / 3
Insulation stripping length	(mm)	8
Tightening torque nominal/max	(Nm)	0,4 / 0,5
Width	(mm)	5
Length	(mm)	43
Height mounted on TH35/7,5	(mm)	52
Height mounted on TH35/15	(mm)	60
Height mounted on G32	(mm)	56
Insulation material temperature index (EN 60216-1)	(°C)	130
Plastic material		Polyamide UL94 V0

APPROVALS



ACCESSORIES		
End section	Grey	CBR/PT/GR (cod. CR111GR)
	Beige	CBR/PT (cod. CR111)
	Blue	-
	Thickness (mm)	1,5
Cross connection	(1)	PM/25/... (cod. PM25...)
	Rated current / Rated current ATEX applications (A)	24
Multiple common bar	250 mm	PMP/25 (cod. PMP25)
Shunting screw and sleeve		CPM/25 (cod. CPM25)
Coloured partition	red	DFU/4/R (cod. DU04R)
Test plug socket		PSD/K (cod. PD011)
Test plug		SDD/1 (cod. DD001)
Marking tag		CNU/8/51 (cod. NU0851S)
Cover for cross-connection		PRP/5 (cod. PRP05)
End bracket	Snap-fit TH35 and G32	BTU (cod. BT005)
	Snap-fit TH35	BTO (cod. BT007)
	Screw TH35	BT/3 (cod. BT003)
	Screw G32	BT/DIN/PO (cod. BT001)

- panel mount version - M6 screws
- possible to create parallel connections (GPA.70)



GREY VERSION	CODE	GA400GR	GF400GR
	TYPE	GPA.70/GR	GPA.70/FIX/GR
BEIGE VERSION	CODE	GA400	GF400
	TYPE	GPA.70	GPA.70/FIX
BLUE VERSION	CODE	GA410	
	TYPE	GPA.70 [EXI]	

TECHNICAL CHARACTERISTICS

Function/type		feed-through	feed-through
Rated cross-section	(mm ²)	70	70
Connecting capacity	Flexible (mm ²)	10 ÷ 95	10 ÷ 95
	Rigid (mm ²)	10 ÷ 95	10 ÷ 95
Electrical characteristics According to European standard IEC EN 60947-7-1	Max AC/DC Voltage (V)	1000	1000
	Max current with rated cross-section (A)	192	192
	Section Caliber	B11	B11
Electrical characteristics According to UL	Max AC/DC Voltage (V)	600	600
	Max current with rated cross-section (A)	215	215
	Section Min-Max (AWG)	8 ÷ 4/0	8 ÷ 4/0
	Tightening torque (lb.in)	79,5	79,5
Rated impulse withstand voltage/pollution degree		12 kV / 3	12 kV / 3
Insulation stripping length	(mm)	25	25
Tightening torque nominal/max	(Nm)	6 / 9 (Allen screw, 4 mm wrench)	6 / 9 (Allen screw, 4 mm wrench)
Width	(mm)	20,5	20,5
Length	(mm)	91	-
Height mounted on TH35/7,5	(mm)	70	-
Height mounted on TH35/15	(mm)	78	-
Height mounted on G32	(mm)	75	-
Length mounted on panel	(mm)	-	102
Fixing distance between centers	(mm)	-	88
Insulation material temperature index (EN 60216-1)	(°C)	130	130
Plastic material		Polyamide UL94 V0	Polyamide UL94 V0

APPROVALS

ACCESSORIES

Cross connection	2 poles preassembled	POF/70 (cod. POF70)	POF/70 (cod. POF70)
	Rated current (A)	192	192
Cover for cross-connection		PRP/08 (cod. PRP08)	PRP/08 (cod. PRP08)
Multiple common bar	250 mm	PMP/08 (cod. PMP08)	PMP/08 (cod. PMP08)
Shunting screw and sleeve		CPM/70 (cod. CPM70) 12 poles	CPM/70 (cod. CPM70) 12 poles
Coloured partition	red	DF/GPA/70/R (cod. DU070R)	DF/GPA/70/R (cod. DU070R)
Test plug socket		PSD/C (cod. PD003)	PSD/C (cod. PD003)
Test plug		SDD/2 (cod. DD002)	SDD/2 (cod. DD002)
Marking tag		CNU/08/51 (cod. NU0851S)	CNU/08/51 (cod. NU0851S)
		CNU/10/61 (cod. NU1061S)	CNU/10/61 (cod. NU1061S)
End bracket	Screw TH35	BT/3 (cod. BT003)	BT/3 (cod. BT003)
	Snap-fit TH35	BTO (cod. BT007)	BTO (cod. BT007)
	Snap-fit TH35 and G32	BTU (cod. BT005)	BTU (cod. BT005)



SCREW CLAMP

- panel mount version - M6 screws
- possible to create parallel connections (GPA.70)



GREY VERSION	CODE	GA100GR	GF100GR
	TYPE	GPA.95/GR	GPA.95/FIX/GR
BEIGE VERSION	CODE	GA100	GF100
	TYPE	GPA.95	GPA.95/FIX
BLUE VERSION	CODE	GA110	
	TYPE	GPA.95 [EX]	

TECHNICAL CHARACTERISTICS

Function/type		feed-through	feed-through
Rated cross-section	(mm ²)	95	95
Connecting capacity	Flexible (mm ²)	10 ÷ 95	10 ÷ 95
	Rigid (mm ²)	10 ÷ 120	10 ÷ 120
Electrical characteristics According to European standard IEC EN 60947-7-1	Max AC/DC Voltage (V)	1000	1000
	Max current with rated cross-section (A)	232	232
	Section Caliber	B12	B12
Electrical characteristics According to UL	Max AC/DC Voltage (V)	600	600
	Max current with rated cross-section (A)	232	232
	Section Min-Max (AWG)	2 ÷ 250 MCM	2 ÷ 250 MCM
Tightening torque (lb.in)	90	90	
Rated impulse withstand voltage/pollution degree		12 kV / 3	12 kV / 3
Insulation stripping length (mm)		30	30
Tightening torque nominal/max (Nm)		6 / 9 (Allen screw, 4 mm wrench)	6 / 9 (Allen screw, 4 mm wrench)
Width (mm)		26	26
Length (mm)		98	-
Height mounted on TH35/7,5 (mm)		87	-
Height mounted on TH35/15 (mm)		95	-
Height mounted on G32 (mm)		91	-
Length mounted on panel (mm)		-	111
Fixing distance between centers (mm)		-	97
Insulation material temperature index (EN 60216-1) (°C)		130	130
Plastic material		Polyamide UL94 V0	Polyamide UL94 V0

APPROVALS



ACCESSORIES			
Cross connection	2 poles preassembled	-	-
	Rated current (A)	-	-
Cover for cross-connection		-	-
Multiple common bar	250 mm	-	-
Shunting screw and sleeve		-	-
Coloured partition	red	-	-
Test plug socket		-	-
Test plug		-	-
Marking tag		CNU/08/51 (cod. NU0851S)	CNU/08/51 (cod. NU0851S)
		CNU/10/61 (cod. NU1061S)	CNU/10/61 (cod. NU1061S)
End bracket	Screw TH35	BT/3 (cod. BT003)	BT/3 (cod. BT003)
	Snap-fit TH35	BTO (cod. BT007)	BTO (cod. BT007)
	Snap-fit TH35 and G32	BTU (cod. BT005)	BTU (cod. BT005)

- panel mount version - M6 screws
- possible to create parallel connections (GPA.70)



GREY VERSION	CODE TYPE	GA200GR GPA.150/GR	GF200GR GPA.150/FX/GR
BEIGE VERSION	CODE TYPE	GA200 GPA.150	GF200 GPA.150/FIX
BLUE VERSION	CODE TYPE		

TECHNICAL CHARACTERISTICS

Function/type		feed-through	feed-through
Rated cross-section	(mm ²)	150	150
Connecting capacity	Flexible (mm ²)	50 ÷ 150	50 ÷ 150
	Rigid (mm ²)	50 ÷ 185	50 ÷ 185
Electrical characteristics According to European standard IEC EN 60947-7-1	Max AC/DC Voltage (V)	1000	1000
	Max current with rated cross-section (A)	309	309
	Section Caliber	B14	B14
Electrical characteristics According to UL	Max AC/DC Voltage (V)	600	600
	Max current with rated cross-section (A)	309	309
	Section Min-Max (AWG)	1/0 ÷ 350 MCM	1/0 ÷ 350 MCM
	Tightening torque (lb.in)	142	142
Rated impulse withstand voltage/pollution degree		12 kV / 3	12 kV / 3
Insulation stripping length	(mm)	35	35
Tightening torque nominal/max	(Nm)	10 / 15 (Allen screw, 5 mm wrench)	10 / 15 (Allen screw, 5 mm wrench)
Width	(mm)	31	31
Length	(mm)	108	-
Height mounted on TH35/7,5	(mm)	99	-
Height mounted on TH35/15	(mm)	103	-
Height mounted on G32	(mm)	106	-
Length mounted on panel	(mm)	-	122
Fixing distance between centers	(mm)	-	106
Insulation material temperature index (EN 60216-1)	(°C)	130	130
Plastic material		Polyamide UL94 V0	Polyamide UL94 V0

APPROVALS



ACCESSORIES			
Cross connection	2 poles preassembled	-	-
	Rated current (A)	-	-
Cover for cross-connection		-	-
Multiple common bar	250 mm	-	-
Shunting screw and sleeve		-	-
Coloured partition	red	-	-
Test plug socket		-	-
Test plug		-	-
Marking tag		CNU/08/51 (cod. NU0851S)	CNU/08/51 (cod. NU0851S)
		CNU/10/61 (cod. NU1061S)	CNU/10/61 (cod. NU1061S)
End bracket	Screw TH35	BT/3 (cod. BT003)	BT/3 (cod. BT003)
	Snap-fit TH35	BTO (cod. BT007)	BTO (cod. BT007)
	Snap-fit TH35 and G32	BTU (cod. BT005)	BTU (cod. BT005)

- panel mount version - M6 screws
- possible to create parallel connections (GPA.70)



GREY VERSION	CODE TYPE	GA300GR GPA.240/GR	GF300GR GPA.240/FIX/GR
BEIGE VERSION	CODE TYPE	GA300 GPA.240	GF300 GPA.240/FIX
BLUE VERSION	CODE TYPE		

TECHNICAL CHARACTERISTICS

Function/type		feed-through	feed-through
Rated cross-section	(mm ²)	240	240
Connecting capacity	Flexible (mm ²)	95 ÷ 240	95 ÷ 240
	Rigid (mm ²)	50 ÷ 300	50 ÷ 300
Electrical characteristics According to European standard IEC EN 60947-7-1	Max AC/DC Voltage (V)	1000	1000
	Max current with rated cross-section (A)	415	415
	Section Caliber	B16	B16
Electrical characteristics According to UL	Max AC/DC Voltage (V)	600	600
	Max current with rated cross-section (A)	415	415
	Section Min-Max (AWG)	3/0 ÷ 600 MCM	3/0 ÷ 600 MCM
	Tightening torque (lb.in)	300	300
Rated impulse withstand voltage/pollution degree		12 kV / 3	12 kV / 3
Insulation stripping length	(mm)	40	40
Tightening torque nominal/max	(Nm)	14 / 21 (Allen screw, 6 mm wrench)	14 / 21 (Allen screw, 6 mm wrench)
Width	(mm)	37	37
Length	(mm)	119	-
Height mounted on TH35/7,5	(mm)	120	-
Height mounted on TH35/15	(mm)	124	-
Height mounted on G32	(mm)	128	-
Length mounted on panel	(mm)	-	134
Fixing distance between centers	(mm)	-	118
Insulation material temperature index (EN 60216-1)	(°C)	130	130
Plastic material		Polyamide UL94 V0	Polyamide UL94 V0

APPROVALS



ACCESSORIES			
Cross connection	2 poles preassembled	-	-
	Rated current (A)	-	-
Cover for cross-connection		-	-
Multiple common bar	250 mm	-	-
Shunting screw and sleeve		-	-
Coloured partition	red	-	-
Test plug socket		-	-
Test plug		-	-
Marking tag		CNU/08/51 (cod. NU0851S)	CNU/08/51 (cod. NU0851S)
		CNU/10/61 (cod. NU1061S)	CNU/10/61 (cod. NU1061S)
End bracket	Screw TH35	BT/3 (cod. BT003)	BT/3 (cod. BT003)
	Snap-fit TH35	BTO (cod. BT007)	BTO (cod. BT007)
	Snap-fit TH35 and G32	BTU (cod. BT005)	BTU (cod. BT005)

- same profile and dimensions of the corresponding terminal blocks of the CBC and GPA Series
- No end plates required, already closed in yellow/green shells



YELLOW/GREEN VERSION	CODE TYPE	T0120 TEC.6/0	T0510 TEC.10/0	T0220 TEC.16/0
----------------------	-----------	------------------	-------------------	-------------------

TECHNICAL CHARACTERISTICS				
Function/type		earth terminal block	earth terminal block	earth terminal block
Rated cross-section	(mm ²)	6	10	16
Connecting capacity	Flexible (mm ²)	0.5÷10	1,5 ÷ 16	1,5 ÷ 25
	Rigid (mm ²)	0.5÷10	1,5 ÷ 16	1,5 ÷ 25
	Max. flexible with ferrule - ferrule type (mm ²)	6 - WP60/20	10 - WP100/21	16 - WP160/22
Electrical characteristics According to European standard IEC EN 60947-7-2	Max AC/DC Voltage (V)	-	-	-
	Max current with rated cross-section (A)	41	57	76
	Section Caliber	A5	B6	B7
Electrical characteristics According to UL	Max AC/DC Voltage (V)	600	-	-
	Max current with rated cross-section (A)	-	-	-
	Section Min-Max (AWG)	24-8	-	-
	Tightening torque (lb.in)	15	-	-
Rated impulse withstand voltage/pollution degree		8kV / 3	8kV / 3	8kV / 3
Insulation stripping length	(mm)	10	12	15
Tightening torque nominal/max	(Nm)	0,8 / 1,4	1,2 / 1,9	2 / 1,2
Width	(mm)	8	10	12
Length	(mm)	44	44	47
Height mounted on TH35/7,5	(mm)	52	52	56
Height mounted on TH35/15	(mm)	60	60	64
Insulation material temperature index (EN 60216-1)	(°C)	130	130	130
Plastic material		Polyamide UL94 V0	Polyamide UL94 V0	Polyamide UL94 V0

APPROVALS



ACCESSORIES

Marking tag		CNU/08/51 [cod. NU0851S] CNU/10/61 [cod. NU1061S]	CNU/08/51 [cod. NU0851S] CNU/10/61 [cod. NU1061S]	CNU/08/51 [cod. NU0851S] CNU/10/61 [cod. NU1061S]
End bracket	Snap-fit TH35 and G32	BTU (cod. BT005)	BTU (cod. BT005)	BTU (cod. BT005)
	Snap-fit TH35	BTO (cod. BT007)	BTO (cod. BT007)	BTO (cod. BT007)
	Screw TH35	BT/3 (cod. BT003)	BT/3 (cod. BT003)	BT/3 (cod. BT003)

MAXIMUM SHORT-TIME WITHSTAND CURRENTS ALLOCATED TO THE RAIL PROFILE

Rail profile	Material	Equivalent E-cu cross-section mm ²	Short-time withstand current 1s kA	Thermal rated current of a PEN busbar A
Top hat rail IEC 60715/TH 15 - 5.5	Steel	10	1.2	-
	Copper	25	3	101
	Aluminium	16	1.92	76
Top hat rail IEC 60715/TH 35 - 7.5	Steel	16	1.92	-
	Copper	50	6	150
	Aluminium	35	4.2	125
Top hat rail IEC 60715/TH 35 - 15	Steel	50	6	-
	Copper	150	18	309
	Aluminium	95	11.4	232

Taken from CEI EN 60947-7-2 standard

- same profile and dimensions of the corresponding terminal blocks of the CBC and GPA Series
- No end plates required, already closed in yellow/green shells

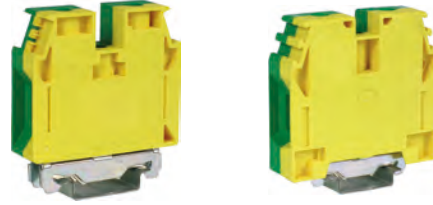

YELLOW/GREEN VERSION		CODE	T0320	T0810
		TYPE	TEC.35/0	TEC.70/0
TECHNICAL CHARACTERISTICS				
Function/type			earth terminal block	earth terminal block
Rated cross-section		(mm ²)	35	70
Connecting capacity	Flexible	(mm ²)	2,5 ÷ 50	10 ÷ 95
	Rigid	(mm ²)	2,5 ÷ 50	10 ÷ 95
	Max. flexible with ferrule - ferrule type	(mm ²)	-	-
Electrical characteristics According to European standard IEC EN 60947-7-2	Max AC/DC Voltage	(V)	-	-
	Max current with rated cross-section	(A)	125	192
	Section	Caliber	B9	B11
Electrical characteristics According to UL	Max AC/DC Voltage	(V)	-	-
	Max current with rated cross-section	(A)	-	-
	Section Min-Max	(AWG)	-	-
	Tightening torque	(lb.in)	-	-
Rated impulse withstand voltage/pollution degree			12kV / 3	8kV / 3
Insulation stripping length		(mm)	18	25
Tightening torque nominal/max		(Nm)	2,5 / 5	6 / 9
Width		(mm)	16	20.5
Length		(mm)	56	70
Height mounted on TH35/7,5		(mm)	63	81.5
Height mounted on TH35/15		(mm)	71	74
Insulation material temperature index (EN 60216-1)		(°C)	130	130
Plastic material			Polyamide UL94 V0	Polyamide UL94 V0

APPROVALS



ACCESSORIES			
Marking tag		CNU/08/51 (cod. NU0851S)	CNU/08/51 (cod. NU0851S)
		CNU/10/61 (cod. NU1061S)	CNU/10/61 (cod. NU1061S)
End bracket	Snap-fit TH35 and G32	BTU (cod. BT005)	BTU (cod. BT005)
	Snap-fit TH35	BTO (cod. BT007)	BTO (cod. BT007)
	Screw TH35	BT/3 (cod. BT003)	BT/3 (cod. BT003)

MAXIMUM SHORT-TIME WITHSTAND CURRENTS ALLOCATED TO THE RAIL PROFILE

Rail profile	Material	Equivalent E-cu cross-section mm ²	Short-time withstand current 1s kA	Thermal rated current of a PEN busbar A
Top hat rail IEC 60715/TH 15 - 5.5	Steel	10	1.2	-
	Copper	25	3	101
	Aluminium	16	1.92	76
Top hat rail IEC 60715/TH 35 - 7.5	Steel	16	1.92	-
	Copper	50	6	150
	Aluminium	35	4.2	125
Top hat rail IEC 60715/TH 35 - 15	Steel	50	6	-
	Copper	150	18	309
	Aluminium	95	11.4	232

Taken from CEI EN 60947-7-2 standard

Blank lined area for notes.

SCREW CLAMP

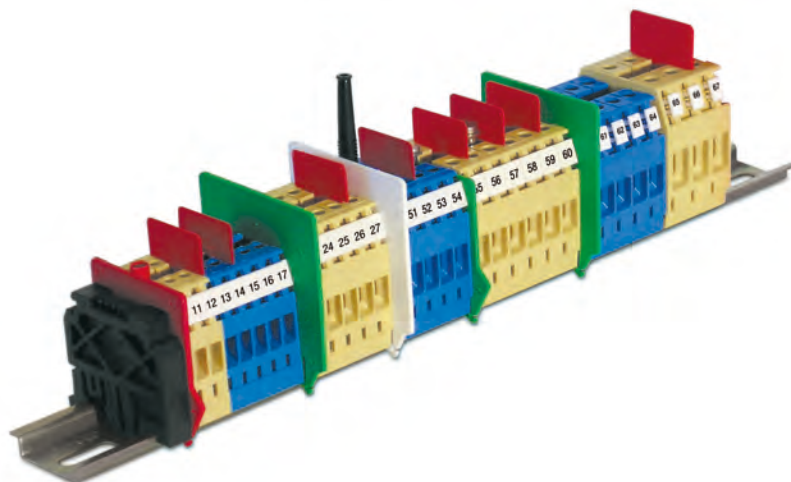

CESI 01 ATEX 090 U
I M2 Ex eb I Mb
II 2 G Ex eb IIC Gb

IECEX CES 09.0009U
Ex eb I Mb
Ex eb IIC Gb

- Behaviour in flame UL94V-0
- Universal mounting on PR/DIN and PR/3 rails in accordance with IEC 60715 standard
- Maximum continual operating temperature 130°C

The CBD Series comprises eight sizes, distinguished by:

- Very small space occupied
- Large connecting capacity
- Effective current capacity higher than established reference values
- Very low contact resistance of the connection
- Materials of excellent quality and, consequently, maximum reliability over time
- Great practicality of use

Cabur has always designated each product mainly with a Code, distinguished by a part in letters (generally 3) and a number, with an interposed dot.

This number defines the **rated cross-section** of the terminal in question; which as laid down in the reference Standard is "the figure, expressed in mm², corresponding to the section of the connectable conductor, declared by the Manufacturer, to which the thermal, mechanical and electrical parameters of the product are referred".

The field of use of the terminal block is however much wider and is defined by its connecting capacity, that is the range of sections of conductors, both rigid and flexible, minimum and maximum, that the terminal block is capable of connecting, in full observance of all the parameters laid down in the reference Standards. In the table provided below, in fact, the "classic" code of each terminal block has been supplemented with the addition, after the existing number, which still indicates the nominal size, of a second numeric value (in reduced character size and in red, separated from the first by a /) which represents the size, in mm², of the maximum flexible conductor effectively connectable to the terminal block. In the event of use of rigid conductors (with single wire or corded) it is necessary to check also what is stated in the technical specifications of each product, under the item "connecting capacity", because in many cases the size of the maximum rigid conductor connectable is even larger.

Considering precisely the confirmed large connecting capacity, some sizes of the CBD Series have been reconsidered; without changing the eight sizes of the Series, the previous CBD.25 and CBD.35 models have been revised and, after the appropriate actions and all the consequent tests, restated respectively as CBD.35 and CBD.50; this latter size, not considered in the past in the range of Cabur terminal blocks, is instead widely used.

Type	Rated cross section (mm ²)	Flexible conductor (mm ²)		Rigid conductor (mm ²)		Gauge	Max. current (A)
		min.	max.	min.	max.		
CBD.2/4	2.5	0.5	4	0.5	4	A3	29
CBD.4/6	4	0.5	6	0.5	6	A4	40
CBD.6/10	6	0.5	10	0.5	10	A5	58
CBD.10/16	10	0.5	16	0.5	16	B6	77
CBD.16/25	16	0.5	25	0.5	25	B7	104
CBD.35/35	35	0.5	35	0.5	50	B8	147
CBD.50/50	50	1.5	50	1.0	70	B9	180
CBD.70/95	70	1.5	95	1.0	95	B11	250

APPROVALS



Type of connection:

It is with a screw, on both sides, indirect and self-locking. The clamping screws are accessible only with a special screwdriver and the particular shape of the head makes them impossible to lose. The screw clamping offers the best guarantees of a mechanical seal and of effective passage of the current and is suitable for the connection, with or without special preparation, of conductors of all sections. The tightening and loosening operations are extremely simple and are carried out with commonly-used tools, namely screwdrivers; it is however important, in any case, to use screwdrivers of the right characteristics and dimensions so as not to cause damage either to the screw itself or to the insulating base.

Conducting body:

of the sleeve type, **made entirely of copper-zinc alloy with nickel-plating treatment**; the characteristics of the material used and the manufacturing methods are such as to avoid the phenomenon of possible breakages, known as "seasoning cracks".

Tightening reliability:

opportune orthogonal ribs, at the bottom of the sleeve and on the lower surface of the clamping platelets, ensure in the various situations perfect electrical contact with the conductors and efficient mechanical locking. The grip on the conductor is made particularly effective by the elastic function performed by the clamping platelet; this, in particular, under the pressure of the screw, tends to bend, thus exercising a reaction applied to the head of the screw itself, which opposes unscrewing, even in the presence of dynamic stresses (vibrations).

Ease of insertion:

Inserting the conductor in the terminal block is facilitated:

- by the inclined invitation surfaces made on the insulating base
- by the rounded shape of the clamping platelet
- by the adequate size of the introduction hole with respect to the diameter of the maximum insertable conductor. The conductor introduction depth is limited by a barrier fitted on the insulating base.

Other functions:

besides their main function of feed-through terminal blocks, the CBD terminal blocks are designed and made so as to be able to perform other functions. In fact, using a hole made in the upper part of the conducting body it is possible:

- to create a fixed or switchable transversal connection (cross connection) between two adjoining terminal blocks
- to create a multiple common bar connection between several adjoining terminal blocks
- to insert a socket for a test plug
- to insert a composable test plug for multiple signal testing.

Marking: all CBD terminal blocks offer the possibility of coding, on both sides, using the CNU/8, SNZ or CSC marking tags (this last system enables the composition of alphanumeric codes up to a maximum of four characters, six with the ADR/6 adapter).

Mounting: the polyamide terminal blocks of the CBD Series are made ready to be mounted indifferently on supporting rails of G32 or TH/35 type (IEC 60715 standard), with evident advantages and facilitations in procuring, managing and in general using the product.



TH/35-7.5 rail



TH/35-15 rail



"G 32"-type rail



SNZ marking

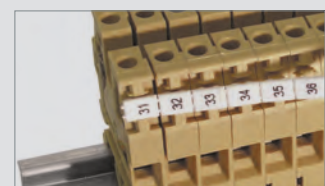

CNU/8 marking



CSC marking

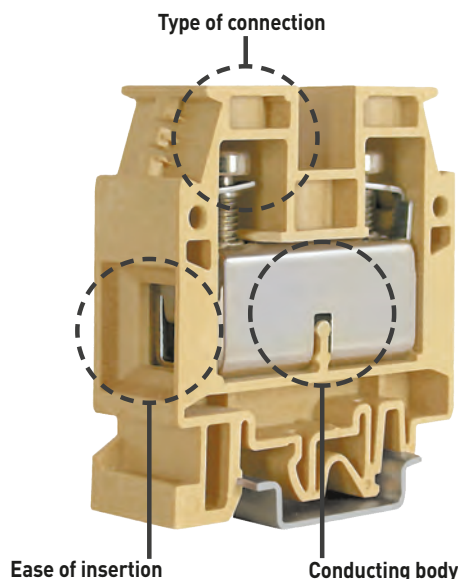

SCREW CLAMP



CESI 01 ATEX 090 U
I M2 Ex eb I Mb
II 2 G Ex eb IIC Gb

IECEX CES 09.0009U
Ex eb I Mb
Ex eb IIC Gb

(1) See chapter accessories for more details

(2) If you need to connect shielded cable with CB009 accessory, the rated voltage is reduce to 200V



BEIGE VERSION	CODE	CB110	CB240	CB340
	TYPE		CBD.2	CBD.4
BLUE VERSION	CODE	CBX12	CBX24	CBX34
	TYPE		CBD.2 (EX)I	CBD.4 (EX)II
GREY VERSION	CODE			
	TYPE			CBD.6

TECHNICAL CHARACTERISTICS

Function/type		Feed-through	Feed-through	Feed-through
Rated cross-section	(mm ²)	2.5	4	6
Connecting capacity	Flexible (mm ²)	0.5 - 4	0.5 - 6	0.5 - 10
	Rigid (mm ²)	0.5 - 4	0.5 - 6	0.5 - 10
	Max. flexible with ferrule - ferrule type (mm ²)	2.5 - WP25/14	4 - WP40/16	6 - WP60/20
Electrical characteristics According to European standard IEC EN 60947-7-1	Max AC/DC Voltage (V)	690	1000	1000
	Max current with rated cross-section (A)	24	32	41
	Section Caliber	A3	A4	A5
Electrical characteristics According to UL	Max AC/DC Voltage (V)	600	600	600
	Max current with rated cross-section (A)	20 / 25	30 / 32	50
	Section Min-Max (AWG)	20 - 12	20 - 10	20 - 8
	Tightening torque (lb.in)	5.5	8.9	13.3
Electrical characteristics According to ATEX directive and IEC ex standard	Max AC/DC voltage with G32 rail / TH35 rail (V)	400 / 630	500 / 630	500 / 630
	Max current with rated cross-section (A)	24	32	41
Operating Temperature (°C)		-40 ÷ +110	-40 ÷ +110	-40 ÷ +110
Rated impulse withstand voltage/pollution degree		8kV/3	12kV/3	12kV/3
Insulation stripping length (mm)		13	14	14
Tightening torque nominal/max (Nm)		0.4 / 0.8	0.5 / 1.2	0.8 / 1.4
Width (mm)		5.5	6.5	8
Length (mm)		40.5	44	44
Height mounted on TH35/7,5 (mm)		47	52	52
Height mounted on TH35/15 (mm)		55	60	60
Height mounted on G32 (mm)		51	56	56
Insulation material temperature index (EN 60216-1) (°C)		130	130	130
Plastic material		Polyamide UL94 V0	Polyamide UL94 V0	Polyamide UL94 V0

APPROVALS

ACCESSORIES

End section	Grey	-	-	-
	Blue	CB2/PT (Ex)I (cod. CBX13)	CB4/6/PT (Ex)I (cod. CBX25)	CB4/6/PT (Ex)I (cod. CBX25)
	Beige	CB2/PT (cod. CB111)	CB4/6/PT (cod. CB241)	CB4/6/PT (cod. CB241)
	Thickness (mm)	1.5	1.5	1.5
Cross connection	{1}	PM/20/... (cod. PM2...)	PM/40/... (cod. PM4...)	PM/60/... (cod. PM6...)
	Rated current / Rated current ATEX applications (A)	24 / 24	32 / 32	41 / 41
Switchable cross connection		POS/11 (cod. POS11)	POS/42 (cod. POS42)	POS/93 (cod. POS93)
Multiple common bar	250 mm	PMP/01/45 (cod. PMP01) 45 poles	PMP/42/38 (cod. PMP42) 38 poles	PMP/13/31 (cod. PMP13) 31 poles
Shunting screw and sleeve (same, Ex e version)		CPM/21 (cod. CPM21) - CPX/21 (cod. CPX21)	CPM/12 (cod. CPM12) - CPX/12 (cod. CPX12)	CPM/83 (cod. CPM83) - CPX/83 (cod. CPX83)
Coloured partition	red	DFU/1/R (cod. DU01R)	DFU/4/R (cod. DU04R)	DFU/4/R (cod. DU04R)
Cross connection barrier	red	DFM/600 (cod. DF600)	DFM/600 (cod. DF600)	DFM/600 (cod. DF600)
Test plug socket		PSD/D (cod. PD004)	PSD/D (cod. PD004)	PSD/N (cod. PD013)
Test plug		SDD/1 (cod. DD001)	SDD/1 (cod. DD001)	SDD/1 (cod. DD001)
Modular test plug		SDD/5 (cod. DD005)	SDD/6 (cod. DD006)	-
End section for modular test plug		SD5/PT (cod. DD501)	SD6/PT (cod. DD601)	-
Adhesive numbering strip		TMM102105AW	TMM102105AW	TMM102105AW
Warning plate	on adjacent terminal blocks	TQM/02 on 4 (cod. TQM02)	TTM/12 on 3 and on 4 (cod. TTM12)	TTM/15 on 3 (cod. TTM15) - TQM/15 on 4 (cod. TQM15)
Cover for cross-connection		PRP/6 (cod. PRP06)	PRP/6 (cod. PRP06)	PRP/7 (cod. PRP07)
Marking tag		CNU/8/51 (cod. NU0851S) CNU/10/61 (cod. NU1061S)	CNU/8/51 (cod. NU0851S) CNU/10/61 (cod. NU1061S)	CNU/8/51 (cod. NU0851S) CNU/10/61 (cod. NU1061S)
End bracket	Snap-fit TH35 and G32	BTU (cod. BT005)	BTU (cod. BT005)	BTU (cod. BT005)
	Snap-fit TH35	BTO (cod. BT007)	BTO (cod. BT007)	BTO (cod. BT007)
	Screw TH35	BT/3 (cod. BT003)	BT/3 (cod. BT003)	BT/3 (cod. BT003)
	Screw G32	BT/DIN/PO (cod. BT001)	BT/DIN/PO (cod. BT001)	BT/DIN/PO (cod. BT001)
Screening lug	{2}	CBD/SH (cod. CB009)	CBD/SH (cod. CB009)	CBD/SH (cod. CB009)



CESI 01 ATEX 090 U
I M2 Ex eb I Mb
II 2 G Ex eb IIC Gb

IECEX CES 09.0009U
Ex eb I Mb
Ex eb IIC Gb

(1) See chapter accessories for more details

(2) If you need to connect shielded cable with CB009 accessory, the rated voltage is reduce to 250V



BEIGE VERSION	CODE	CB440	CB510	CB610
	TYPE			
BLUE VERSION	CODE	CBX45	CBX52	CBX62
	TYPE			
GREY VERSION	CODE			
	TYPE			

TECHNICAL CHARACTERISTICS

Function/type		Feed-through	Feed-through	Feed-through
Rated cross-section	(mm ²)	10	16	35
Connecting capacity	Flexible (mm ²)	0.5 - 16	0.5 - 25	0.5 - 35
	Rigid (mm ²)	0.5 - 16	0.5 - 25	0.5 - 50
	Max. flexible with ferrule - ferrule type (mm ²)	10 - WP100/21	16 - WP160/22	35 - WP350/30
Electrical characteristics According to European standard IEC EN 60947-7-1	Max AC/DC Voltage (V)	1000	1000	1000
	Max current with rated cross-section (A)	57	76	125
	Section Caliber	B6	B7	B8
Electrical characteristics According to UL	Max AC/DC Voltage (V)	600	600	600
	Max current with rated cross-section (A)	60	100	125
	Section Min-Max (AWG)	20 - 6	20 - 3	16 - 1
	Tightening torque (lb.in)	13.3	19.9	22.1
Electrical characteristics According to ATEX directive and IEC ex standard	Max AC/DC voltage with G32 rail / TH35 rail (V)	500 / 630	630 / 630	630 / 630
	Max current with rated cross-section (A)	57	76	125
Operating Temperature (°C)		-40 ÷ +110	-40 ÷ +110	-40 ÷ +110
Rated impulse withstand voltage/pollution degree		12 KV / 3	12 KV / 3	12 KV / 3
Insulation stripping length (mm)		14	18	20
Tightening torque nominal/max (Nm)		1,2 / 1,9	1,8 / 3	2 / 3,5
Width (mm)		10	12	16
Length (mm)		44	47	52
Height mounted on TH35/7,5 (mm)		55	57	60
Height mounted on TH35/15 (mm)		63	65	68
Height mounted on G32 (mm)		59	61	64
Insulation material temperature index (EN 60216-1) (°C)		130	130	130
Plastic material		Polyamide UL94 V0	Polyamide UL94 V0	Polyamide UL94 V0

APPROVALS

ACCESSORIES

	Grey	-	-	-
End section	Blue	CB10/PT (Ex)i (cod. CBX44)	CB16/PT (Ex)i (cod.CBX53)	CB35/PT (Ex)i (cod. CBX63)
	Beige	CB10/PT (cod. CB431)	CB16/PT (cod.CB511)	CB35/PT (cod. CB611)
	Thickness (mm)	1.5	1.5	1.5
Cross connection	(1)	PM/10/... (cod. PM10...)	POF/44(cod.POF44) - PFX/44 (cod. PFX44)	POF/06 (cod. POF06) - PFX/06 (cod. PFX06)
	Rated current / Rated current ATEX applications (A)	57 / 57	76 / 76	125 / 125
Switchable cross connection		POS/44 (cod. POS44)	POS/44 (cod. POS44)	POS/66 (cod. POS66)
Multiple common bar 250 mm		PMP/04/25 (cod.PMP04) 25 poles	PMP/05/21 (cod. PMP05) 21 poles	PMP/06/16 (cod. PMP06) 16 poles
Shunting screw and sleeve (same, Ex e version)		CPM/03 (cod. CPM03) - CPX/03 (cod. CPX03)	CPM/44 (cod. CPM44) - CPX/44 (cod. CPX44)	CPM/06 (cod. CPM06) - CPX/06 (cod.CPX06)
Coloured partition red		DFU/4/R (cod. DU04R)	DFU/4/R (cod. DU04R)	DFU/5/R (cod. DU05R)
Cross connection barrier red		DFM/700 (cod. DF700)	DFM/700 (cod. DF700)	DFM/700 (cod. DF700)
Test plug socket		PSD/B (cod. PD002)	PSD/B (cod. PD002)	PSD/B (cod. PD002)
Test plug		SDD/2 (cod. DD002)	SDD/2 (cod. DD002)	SDD/2 (cod. DD002)
Modular test plug		-	-	-
End section for modular test plug		-	-	-
Adhesive numbering strip		TMM102105AW	TMM102105AW	TMM102105AW
Warning plate on adjacent terminal blocks		TTM/04 on 3 (cod. TTM04) - TQM/04 on 4 (cod. TQM04)	TUM/05 on 3 and on 4 (cod. TUM05)	TUM/06 on 3 and on 4 (cod. TUM06)
Cover for cross-connection		PRP/7 (cod. PRP07)	PRP/7 (cod. PRP07)	PRP/8 (cod. PRP08)
Marking tag		CNU/8/51 (cod. NU0851S)	CNU/8/51 (cod. NU0851S)	CNU/8/51 (cod. NU0851S)
		CNU/10/61 (cod. NU1061S)	CNU/10/61 (cod. NU1061S)	CNU/10/61 (cod. NU1061S)
End bracket	Snap-fit TH35 and G32	BTU (cod. BT005)	BTU (cod. BT005)	BTU (cod. BT005)
	Snap-fit TH35	BTO (cod. BT007)	BTO (cod. BT007)	BTO (cod. BT007)
	Screw TH35	BT/3 (cod. BT003)	BT/3 (cod. BT003)	BT/3 (cod. BT003)
	Screw G32	BT/DIN/PO (cod. BT001)	BT/DIN/PO (cod. BT001)	BT/DIN/PO (cod. BT001)
Screening lug (2)		CBD/SH (cod. CB009)	-	-



CESI 01 ATEX 090 U
I M2 Ex eb I Mb
II 2 G Ex eb IIC Gb

IECEX CES 09.0009U
Ex eb I Mb
Ex eb IIC Gb

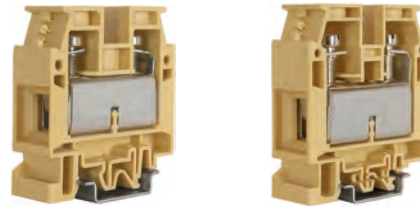

BEIGE VERSION	CODE	CB710	CB810
	TYPE	CBD.50	CBD.70
BLUE VERSION	CODE	CBX72	CBX82
	TYPE	CBD.50 (EXII)	CBD.70 (EXII)
GREY VERSION	CODE	CB710GR	CB810GR
	TYPE	CBD.50/GR	CBD.70/GR

TECHNICAL CHARACTERISTICS

Function/type		Feed-through	Feed-through
Rated cross-section	(mm ²)	50	70
Connecting capacity	Flexible (mm ²)	1.5 - 50	1.5 - 95
	Rigid (mm ²)	1 - 70	1 - 95
	Max. flexible with ferrule - ferrule type (mm ²)	50 - WP500/40	-
Electrical characteristics According to European standard IEC EN 60947-7-1	Max AC/DC Voltage (V)	1000	1000
	Max current with rated cross-section (A)	150	192
	Section Caliber	B9	B11
Electrical characteristics According to UL	Max AC/DC Voltage (V)	600	600
	Max current with rated cross-section (A)	130	220
	Section Min-Max (AWG)	16 - 1	12 - 4/0
	Tightening torque (lb.in)	33.2	50
Electrical characteristics According to ATEX directive and IEC ex standard	Max AC/DC voltage with G32 rail / TH35 rail (V)	630 / 630	630 / 630
	Max current with rated cross-section (A)	150	173
Operating Temperature (°C)		-40 ÷ +110	-40 ÷ +110
Rated impulse withstand voltage/pollution degree		12 KV / 3	12 KV / 3
Insulation stripping length (mm)		22	26
Tightening torque nominal/max (Nm)		2,5 / 5	3 / 8
Width (mm)		18	20.5
Length (mm)		57	62
Height mounted on TH35/7,5 (mm)		62	71
Height mounted on TH35/15 (mm)		70	79
Height mounted on G32 (mm)		66	75
Insulation material temperature index (EN 60216-1) (°C)		130	130
Plastic material		Polyamide UL94 V0	Polyamide UL94 V0

APPROVALS

ACCESSORIES

End section	Grey	CB50/PT/GR (cod. CB711GR)	CB70/PT/GR (cod. CB811GR)
	Blue	CB50/PT (Ex)i (cod. CBX73)	CB70/PT (Ex)i (cod. CBX83)
	Beige	CB50/PT (cod. CB711)	CB70/PT (cod. CB811)
	Thickness (mm)	1.5	1.5
Cross connection	{1}	POF/07 (cod. POF07) - PFX/07 (cod. PFX07)	POF/08 (cod. POF08) - PFX/08 (cod. PFX08)
	Rated current / Rated current ATEX applications (A)	150 / 150	192 / 155
Switchable cross connection		POS/77 (cod. POS77)	POS/08 (cod. POS08)
Multiple common bar	250 mm	PMP/07/14 (cod. PMP07) 14 poles CPM/07 (cod. CPM07) - CPX/07 (cod. CPX07)	PMP/08/12 (cod. PMP08) 12 poles CPM/08 (cod. CPM08) - CPX/08 (cod. CPX08)
Shunting screw and sleeve (same, Ex e version)			
Coloured partition	red	DFU/5/R (cod. DU05R)	DFU/6/R (cod. DU06R)
Cross connection barrier	red	DFM/700 (cod. DF700)	DFM/700 (cod. DF700)
Test plug socket		PSD/C (cod. PD003)	PSD/C (cod. PD003)
Test plug		SDD/2 (cod. DD002)	SDD/2 (cod. DD002)
Modular test plug		-	-
End section for modular test plug		-	-
Adhesive numbering strip		TMM102105AW	TMM102105AW
Warning plate	on adjacent terminal blocks	TUM/07 on 3 and on 4 TUM07	TUM/08 on 3 and on 4 TUM08
Cover for cross-connection		PRP/8 (cod. PRP08)	PRP/8 (cod. PRP08)
Marking tag		CNU/8/51 (cod. NU0851S) CNU/10/61 (cod. NU1061S)	CNU/8/51 (cod. NU0851S) CNU/10/61 (cod. NU1061S)
		BTU (cod. BT005)	BTU (cod. BT005)
End bracket	Snap-fit TH35 and G32	BTU (cod. BT005)	BTU (cod. BT005)
	Snap-fit TH35	BTO (cod. BT007)	BTO (cod. BT007)
	Screw TH35	BT/3 (cod. BT003)	BT/3 (cod. BT003)
	Screw G32	BT/DIN/PO (cod. BT001)	BT/DIN/PO (cod. BT001)
Screening lug	{2}	-	-

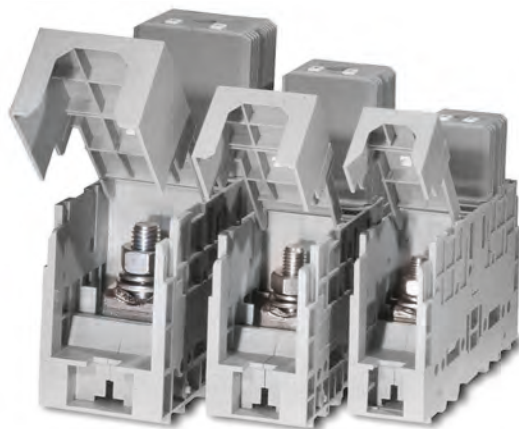

CES I 13 ATEX 038 U
I M2 Ex eb I Mb
II 2 G Ex eb IIC Gb

IECEX CES 13.0012U
Ex eb I Mb
Ex eb IIC Gb

- Mounting for both PR/DIN and PR/3 rails which meet IEC 60715 norms, "G32" and TH/35 types
- Nominal voltage 1000 V
- Panel mount version
- Possibility of parallel cross connection
- Available in the /BB (bar-bar), /BC (bar-cable), /CC (cable-cable) versions
- Available in grey and beige
- Maximum continual operating temperature 130°C

Tightening reliability: the reliability of the connection (wire terminal or bar) is guaranteed by a screw and locking nut, with the interposition of a flat washer and an elastic washer, useful above all for countering the effects of the dynamic stresses. In the versions made ready for clamping of the conductors, without preparation. The reliability of the connection is ensured by the action and the particular wrapping shape of the clamping clip, the elastic reaction of which to the force pressing down on the conductor works as a lock under the head of the clamping screw, stopping it from loosening, even in the presence of vibrations. The conductor bar is also made with an appropriate concave seat so as to increase the grip of the conductors; in addition both the contact surface of the clamping clip and the concave part of the bar feature, along the entire length, crosswise channels that help to improve the connection characteristics, as regards both the mechanical retention of the conductors and the electrical contact, guaranteeing low contact resistances.

- Protection for the "bar" versions: this protection which in the normal installation conditions has a longitudinal position with respect to the axis of the terminal block, can easily be rotated, using a simple screwdriver (as prescribed by the safety standards). In this way it is possible to access the connection unit to be able to work on the wire terminals or on the bars;

- Protection for the "cable" versions: in this case the protection is fixed and snaps in: its development is orthogonal to the axis of the terminal block and it protects the collar, the clip and the clamping screw. It is worth noting the "shutter" device, fitted on the protection in axis to the terminal block and in line with the conductor introduction hole, which enables, with manual action in maximum conditions of safety, partial or total closing of the hole itself and consequently protection of the live parts, in the case of use of conductors with a much smaller section than the nominal one or cabling of the terminal block from only one side.

Mounting: for these power terminal blocks, owing to the notable dimensions and because they are subject to high stresses due to the forces generated by the conductors, a new hooking system has been studied and created. This enables it to be mounted indifferently on the various types of standard mounting rail (IEC 60715). The terminal block is unhooked simply using a screwdriver, inserted in the special slot provided in the hooking system (yellow part). If the mounting rail itself is installed on a flat wall, the dimensions of the GPM terminal blocks make it indispensable to use flat brackets to space the terminal board from the surface adequately. For each terminal block of the Series the version for direct fixing to a panel (/FIX) is also available.

Marking: the GPM terminal blocks enable identification from both sides which can be done with both the CNU/8 (2 elements) and the CSC (up to 5 elements) type marking tags: the two possibilities are not alternatives, but can be combined.

Cross-connection: on this Series of terminal blocks it is also possible to create a cross connection between 2 or 3 adjacent terminal blocks using opportune cross connections; to insert this accessory it is necessary to remove the insulating baffle pre-engraved on the side wall of the insulating body.

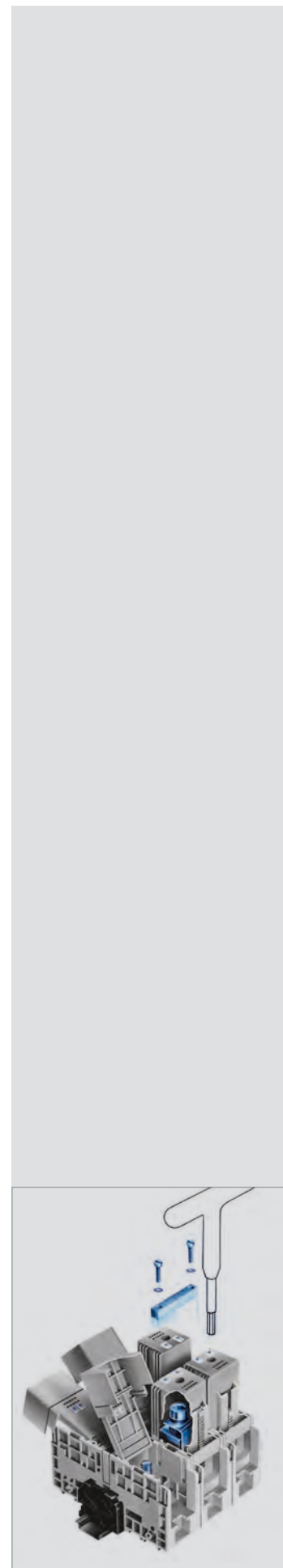

SCREW CLAMP

- panel mount version - M6 screws (recommended with screwdriver and washer slot)
- possibility of parallel cross connection

	CESI 13 ATEX 038 U	IECEX CES 13.0012U
	I M2 Ex e I Mb	Ex e I Mb
	II 2 G Ex e IIC Gb	Ex e IIC Gb

(1) See chapter accessories for more details



BEIGE VERSION	CODE	GP100	GP110
	TYPE	GPM.95/BB	GPM.95/BB/FIX
GREY VERSION	CODE	GP100GR	GP110GR
	TYPE	GPM.95/BB/GR	GPM.95/BB/FIX/GR

TECHNICAL CHARACTERISTICS

Function/type		feed-through	feed-through
Rated cross-section	(mm ²)	95	95
Connecting capacity	Flexible (mm ²)	-	-
	Rigid (mm ²)	-	-
Bars and/or cable lugs	Maximum width / bolt (mm)	22 / M8	22 / M8
Electrical characteristics According to European standard IEC EN 60947-7-1	Max AC/DC Voltage (V)	1000	1000
	Max current with rated cross-section (A)	232	232
	Max current with Max cross-section (A)	320	320
	Section (Caliber)	-	-
Electrical characteristics According to ATEX directive and IEC ex standard	Max AC/DC Voltage (V)	630	630
	Max current with rated cross-section (A)	232	232
	Operating Temperature (°C)	-40 ÷ +80	-40 ÷ +80
Rated impulse withstand voltage/pollution degree		12 KV / 3	12 KV / 3
Insulation stripping length (mm)		-	-
Tightening torque nominal/max	Bar (Nm)	6 / 9	6 / 9
	Cable (Nm)	-	-
Width (mm)		32	32
Length (mm)		176	-
Height mounted on TH35/7,5 (mm)		81	-
Height mounted on TH35/15 (mm)		88	-
Height mounted on G32 (mm)		85	-
Height panel mount (mm)		-	76
Length panel mount (mm)		-	176
Fixing distance between centres (mm)		-	158
Insulation material temperature index (EN 60216-1) (°C)		130	130
Plastic material		Polyamide UL94 V0	Polyamide UL94 V0

APPROVALS



ACCESSORIES

Permanent cross connection	(1)	POF/95/... (cod. PO95...)	POF/95/... (cod. PO95...)
	Rated current (A)	-	-
Mounting rail support	flat for PR/DIN e PR/3	ACI121213 (cod. Z121213)	ACI121213 (cod. Z121213)
	sloped for PR/DIN e PR/3	ACI121024 (cod. Z121024)	ACI121024 (cod. Z121024)
Marking tag		CNU/08/51 (cod. NU0851S)	CNU/08/51 (cod. NU0851S)
		CNU/10/61 (cod. NU1061S)	CNU/10/61 (cod. NU1061S)
End bracket	Snap-fit TH35 and G32	BTU (cod. BT005)	BTU (cod. BT005)
	Snap-fit TH35	BTO (cod. BT007)	BTO (cod. BT007)
	Screw TH35	BT/3 (cod. BT003)	BT/3 (cod. BT003)

- panel mount version - M6 screws (recommended with screwdriver and washer slot)
- possibility of parallel cross connection



CESI 13 ATEX 038 U
I M2 Ex e I Mb
II 2 G Ex e IIC Gb

IECEX CES 13.0012U
Ex e I Mb
Ex e IIC Gb

(1) See chapter accessories for more details

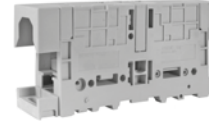

BEIGE VERSION	CODE	GP400	GP410
	TYPE	GPM.150/BB	GPM.150/BB/FIX
GREY VERSION	CODE	GP400GR	GP410GR
	TYPE	GPM.150/BB/GR	GPM.150/BB/FIX/GR

TECHNICAL CHARACTERISTICS

Function/type		feed-through	feed-through
Rated cross-section	(mm ²)	150	150
Connecting capacity	Flexible (mm ²)	-	-
	Rigid (mm ²)	-	-
Bars and/or cable lugs	Maximum width / bolt (mm)	32 / M10	32 / M10
Electrical characteristics According to European standard IEC EN 60947-7-1	Max AC/DC Voltage (V)	1000	1000
	Max current with rated cross-section (A)	309	309
	Max current with Max cross-section (A)	440	440
Electrical characteristics According to ATEX directive and IEC ex standard	Section Caliber	-	-
	Max AC/DC Voltage (V)	1000	1000
	Max current with rated cross-section (A)	309	309
	Operating Temperature (°C)	-40 ÷ +80	-40 ÷ +80
Rated impulse withstand voltage/pollution degree		12 KV / 3	12 KV / 3
Insulation stripping length	(mm)	-	-
Tightening torque nominal/max	Bar (Nm)	10 / 15	10 / 15
	Cable (Nm)	-	-
Width	(mm)	42	42
Length	(mm)	200	-
Height mounted on TH35/7,5	(mm)	81	-
Height mounted on TH35/15	(mm)	88	-
Height mounted on G32	(mm)	85	-
Height panel mount	(mm)	-	76
Length panel mount	(mm)	-	200
Fixing distance between centres	(mm)	-	158
Insulation material temperature index (EN 60216-1)	(°C)	130	130
Plastic material		Polyamide UL94 V0	Polyamide UL94 V0

APPROVALS



ACCESSORIES			
Permanent cross connection	(1)	PFX/150/... (cod. PX15...)	PFX/150/... (cod. PX15...)
	Rated current (A)	-	-
Mounting rail support	flat for PR/DIN e PR/3	ACI121213 (cod. Z121213)	ACI121213 (cod. Z121213)
	sloped for PR/DIN e PR/3	ACI121024 (cod. Z121024)	ACI121024 (cod. Z121024)
Marking tag		CNU/08/51 (cod. NU0851S)	CNU/08/51 (cod. NU0851S)
		CNU/10/61 (cod. NU1061S)	CNU/10/61 (cod. NU1061S)
End bracket	Snap-fit TH35 and G32	BTU (cod. BT005)	BTU (cod. BT005)
	Snap-fit TH35	BTO (cod. BT007)	BTO (cod. BT007)
	Screw TH35	BT/3 (cod. BT003)	BT/3 (cod. BT003)

- panel mount version - M6 screws (recommended with screwdriver and washer slot)
- possibility of parallel cross connection

	CESI 13 ATEX 038 U	IECEX CES 13.0012U
	I M2 Ex e I Mb	Ex e I Mb
	II 2 G Ex e IIC Gb	Ex e IIC Gb

(1) See chapter accessories for more details



BEIGE VERSION	CODE	GP700	GP710
GREY VERSION	CODE	GP700GR	GP710GR
	TYPE	GPM.240/BB	GPM.240/BB/FIX
	TYPE	GPM.240/BB/GR	GPM.240/BB/FIX/GR

TECHNICAL CHARACTERISTICS

Function/type		feed-through	feed-through
Rated cross-section	(mm ²)	240	240
Connecting capacity	Flexible (mm ²)	-	-
	Rigid (mm ²)	-	-
Bars and/or cable lugs	Maximum width / bolt (mm)	40 / M12	40 / M12
Electrical characteristics According to European standard IEC EN 60947-7-1	Max AC/DC Voltage (V)	1000	1000
	Max current with rated cross-section (A)	415	415
	Max current with Max cross-section (A)	600	600
Electrical characteristics According to ATEX directive and IEC ex standard	Section Caliber	-	-
	Max AC/DC Voltage (V)	1000	1000
	Max current with rated cross-section (A)	415	415
Rated impulse withstand voltage/pollution degree	(°C)	-40 ÷ +80	-40 ÷ +80
Rated impulse withstand voltage/pollution degree		12 KV / 3	12 KV / 3
Insulation stripping length	(mm)	-	-
Tightening torque nominal/max	Bar (Nm)	14 / 21	14 / 21
	Cable (Nm)	-	-
Width	(mm)	52	52
Length	(mm)	250	-
Height mounted on TH35/7,5	(mm)	89	-
Height mounted on TH35/15	(mm)	96	-
Height mounted on G32	(mm)	93	-
Height panel mount	(mm)	-	84
Length panel mount	(mm)	-	250
Fixing distance between centres	(mm)	-	172
Insulation material temperature index (EN 60216-1)	(°C)	130	130
Plastic material		Polyamide UL94 V0	Polyamide UL94 V0

APPROVALS



ACCESSORIES

Permanent cross connection	(1)	PFX/240/... (cod. PX24...)	PFX/240/... (cod. PX24...)
	Rated current (A)	-	-
Mounting rail support	flat for PR/DIN e PR/3	ACI121213 (cod. Z121213)	ACI121213 (cod. Z121213)
	sloped for PR/DIN e PR/3	ACI121024 (cod. Z121024)	ACI121024 (cod. Z121024)
Marking tag		CNU/08/51 (cod. NU0851S)	CNU/08/51 (cod. NU0851S)
		CNU/10/61 (cod. NU1061S)	CNU/10/61 (cod. NU1061S)
End bracket	Snap-fit TH35 and G32	BTU (cod. BT005)	BTU (cod. BT005)
	Snap-fit TH35	BTO (cod. BT007)	BTO (cod. BT007)
	Screw TH35	BT/3 (cod. BT003)	BT/3 (cod. BT003)

- panel mount version - M6 screws (recommended with screwdriver and washer slot)
- possibility of parallel cross connection



	CESI 13 ATEX 038 U	IECEX CES 13.0012U
	I M2 Ex e I Mb	Ex e I Mb
	II 2 G Ex e IIC Gb	Ex e IIC Gb

(1) See chapter accessories for more details

BEIGE VERSION	CODE	GP200	GP210
	TYPE	GPM.95/BC	GPM.95/BC/FIX
GREY VERSION	CODE	GP200GR	GP210GR
	TYPE	GPM.95/BC/GR	GPM.95/BC/FIX/GR

TECHNICAL CHARACTERISTICS

Function/type		feed-through	feed-through
Rated cross-section	(mm ²)	95	95
Connecting capacity	Flexible	35 ÷ 95	35 ÷ 95
	Rigid	25 ÷ 120	25 ÷ 120
Bars and/or cable lugs	Maximum width / bolt	22 / M8	22 / M8
Electrical characteristics According to European standard IEC EN 60947-7-1	Max AC/DC Voltage	1000	1000
	Max current with rated cross-section	232	232
	Max current with Max cross-section	320	320
	Section	Caliber	B12
Electrical characteristics According to ATEX directive and IEC ex standard	Max AC/DC Voltage	630	630
	Max current with rated cross-section	232	232
	Operating Temperature	-40 ÷ +80	-40 ÷ +80
Rated impulse withstand voltage/pollution degree		12 KV / 3	12 KV / 3
Insulation stripping length	(mm)	35	35
Tightening torque nominal/max	Bar	6 / 9	6 / 9
	Cable	6 / 9	6 / 9
Width	(mm)	32	32
Length	(mm)	158	-
Height mounted on TH35/7,5	(mm)	113	-
Height mounted on TH35/15	(mm)	120	-
Height mounted on G32	(mm)	117	-
Height panel mount	(mm)	-	108
Length panel mount	(mm)	-	175
Fixing distance between centres	(mm)	-	158
Insulation material temperature index (EN 60216-1)	(°C)	130	130
Plastic material		Polyamide UL94 V0	Polyamide UL94 V0



APPROVALS

ACCESSORIES			
Permanent cross connection	(1)	POF/95/... (cod. P095...)	POF/95/... (cod. P095...)
	Rated current	(A)	-
Mounting rail support	flat for PR/DIN e PR/3	ACI121213 (cod. Z121213)	ACI121213 (cod. Z121213)
	sloped for PR/DIN e PR/3	ACI121024 (cod. Z121024)	ACI121024 (cod. Z121024)
Marking tag		CNU/08/51 (cod. NU0851S)	CNU/08/51 (cod. NU0851S)
		CNU/10/61 (cod. NU1061S)	CNU/10/61 (cod. NU1061S)
End bracket	Snap-fit TH35 and G32	BTU (cod. BT005)	BTU (cod. BT005)
	Snap-fit TH35	BTO (cod. BT007)	BTO (cod. BT007)
	Screw TH35	BT/3 (cod. BT003)	BT/3 (cod. BT003)

SCREW CLAMP

- panel mount version - M6 screws (recommended with screwdriver and washer slot)
- possibility of parallel cross connection



CESI 13 ATEX 038 U
I M2 Ex e I Mb
II 2 G Ex e IIC Gb

IECEX CES 13.0012U
Ex e I Mb
Ex e IIC Gb

(1) See chapter accessories for more details



BEIGE VERSION	CODE	GP500	GP510
	TYPE	GPM.150/BC	GPM.150/BC/FIX
GREY VERSION	CODE	GP500GR	GP510GR
	TYPE	GPM.150/BC/GR	GPM.150/BC/FIX/GR

TECHNICAL CHARACTERISTICS

Function/type		feed-through	feed-through
Rated cross-section	(mm ²)	150	150
Connecting capacity	Flexible	(mm ²) 50 ÷ 150	50 ÷ 150
	Rigid	(mm ²) 35 ÷ 185	35 ÷ 185
Bars and/or cable lugs	Maximum width / bolt	(mm) 32 / M10	32 / M10
Electrical characteristics According to European standard IEC EN 60947-7-1	Max AC/DC Voltage	(V) 1000	1000
	Max current with rated cross-section	(A) 309	309
	Max current with Max cross-section	(A) 440	440
	Section	Caliber B14	B14
Electrical characteristics According to ATEX directive and IEC ex standard	Max AC/DC Voltage	(V) 1000	1000
	Max current with rated cross-section	(A) 309	309
	Operating Temperature	(°C) -40 ÷ +80	-40 ÷ +80
Rated impulse withstand voltage/pollution degree		12 KV / 3	12 KV / 3
Insulation stripping length	(mm)	35	35
Tightening torque nominal/max	Bar	(Nm) 10 / 15	10 / 15
	Cable	(Nm) 10 / 15	10 / 15
Width	(mm)	42	42
Length	(mm)	170	-
Height mounted on TH35/7,5	(mm)	134	-
Height mounted on TH35/15	(mm)	141	-
Height mounted on G32	(mm)	138	-
Height panel mount	(mm)	-	129
Length panel mount	(mm)	-	187
Fixing distance between centres	(mm)	-	158
Insulation material temperature index (EN 60216-1)	(°C)	130	130
Plastic material		Polyamide UL94 V0	Polyamide UL94 V0

APPROVALS



ACCESSORIES			
Permanent cross connection	(1)	PFX/150/... (cod. PX15...)	PFX/150/... (cod. PX15...)
	Rated current	(A) -	-
Mounting rail support	flat for PR/DIN e PR/3	ACI121213 (cod. Z121213)	ACI121213 (cod. Z121213)
	sloped for PR/DIN e PR/3	ACI121024 (cod. Z121024)	ACI121024 (cod. Z121024)
Marking tag		CNU/08/51 (cod. NU0851S)	CNU/08/51 (cod. NU0851S)
		CNU/10/61 (cod. NU1061S)	CNU/10/61 (cod. NU1061S)
End bracket	Snap-fit TH35 and G32	BTU (cod. BT005)	BTU (cod. BT005)
	Snap-fit TH35	BTO (cod. BT007)	BTO (cod. BT007)
	Screw TH35	BT/3 (cod. BT003)	BT/3 (cod. BT003)

- panel mount version - M6 screws (recommended with screwdriver and washer slot)
- possibility of parallel cross connection



CESI 13 ATEX 038 U
I M2 Ex e I Mb
II 2 G Ex e IIC Gb

IECEX CES 13.0012U
Ex e I Mb
Ex e IIC Gb

(1) See chapter accessories for more details



BEIGE VERSION	CODE	GP800	GP810
	TYPE	GPM.240/BC	GPM.240/BC/FIX
GREY VERSION	CODE	GP800GR	GP810GR
	TYPE	GPM.240/BC/GR	GPM.240/BC/FIX/GR

TECHNICAL CHARACTERISTICS

Function/type		feed-through	feed-through
Rated cross-section	(mm ²)	240	240
Connecting capacity	Flexible (mm ²)	95 ÷ 240	95 ÷ 240
	Rigid (mm ²)	50 ÷ 300	50 ÷ 300
Bars and/or cable lugs	Maximum width / bolt (mm)	40 / M12	40 / M12
Electrical characteristics According to European standard IEC EN 60947-7-1	Max AC/DC Voltage (V)	1000	1000
	Max current with rated cross-section (A)	415	415
	Max current with Max cross-section (A)	600	600
	Section (Caliber)	B16	B16
Electrical characteristics According to ATEX directive and IEC ex standard	Max AC/DC Voltage (V)	1000	1000
	Max current with rated cross-section (A)	415	415
	Operating Temperature (°C)	-40 ÷ +80	-40 ÷ +80
Rated impulse withstand voltage/pollution degree		12 KV / 3	12 KV / 3
Insulation stripping length (mm)		43	43
Tightening torque nominal/max	Bar (Nm)	14 / 21	14 / 21
	Cable (Nm)	14 / 21	14 / 21
Width (mm)		52	52
Length (mm)		202	-
Height mounted on TH35/7,5 (mm)		150	-
Height mounted on TH35/15 (mm)		157	-
Height mounted on G32 (mm)		154	-
Height panel mount (mm)		-	144
Length panel mount (mm)		-	219
Fixing distance between centres (mm)		-	172
Insulation material temperature index (EN 60216-1) (°C)		130	130
Plastic material		Polyamide UL94 V0	Polyamide UL94 V0

APPROVALS



ACCESSORIES

Permanent cross connection	(1)	PFX/240/... (cod. PX24...)	PFX/240/... (cod. PX24...)
	Rated current (A)	-	-
Mounting rail support	flat for PR/DIN e PR/3	ACI121213 (cod. Z121213)	ACI121213 (cod. Z121213)
	sloped for PR/DIN e PR/3	ACI121024 (cod. Z121024)	ACI121024 (cod. Z121024)
Marking tag		CNU/08/51 (cod. NU0851S)	CNU/08/51 (cod. NU0851S)
		CNU/10/61 (cod. NU1061S)	CNU/10/61 (cod. NU1061S)
End bracket	Snap-fit TH35 and G32	BTU (cod. BT005)	BTU (cod. BT005)
	Snap-fit TH35	BTO (cod. BT007)	BTO (cod. BT007)
	Screw TH35	BT/3 (cod. BT003)	BT/3 (cod. BT003)

- panel mount version - M6 screws (recommended with screwdriver and washer slot)
- possibility of parallel cross connection



CESI 13 ATEX 038 U
I M2 Ex e I Mb
II 2 G Ex e IIC Gb

IECEX CES 13.0012U
Ex e I Mb
Ex e IIC Gb

(1) See chapter accessories for more details



BEIGE VERSION	CODE	GP300	GP310
	TYPE	GPM.95/CC	GPM.95/CC/FIX
GREY VERSION	CODE	GP300GR	GP310GR
	TYPE	GPM.95/CC/GR	GPM.95/CC/FIX/GR

TECHNICAL CHARACTERISTICS

Function/type		feed-through	feed-through
Rated cross-section	(mm ²)	95	95
Connecting capacity	Flexible (mm ²)	35 ÷ 95	35 ÷ 95
	Rigid (mm ²)	25 ÷ 120	25 ÷ 120
Bars and/or cable lugs	Maximum width / bolt (mm)	-	-
Electrical characteristics According to European standard IEC EN 60947-7-1	Max AC/DC Voltage (V)	1000	1000
	Max current with rated cross-section (A)	232	232
	Max current with Max cross-section (A)	320	320
	Section (Caliber)	B12	B12
Electrical characteristics According to ATEX directive and IEC ex standard	Max AC/DC Voltage (V)	630	630
	Max current with rated cross-section (A)	232	232
	Operating Temperature (°C)	-40 ÷ +80	-40 ÷ +80
Rated impulse withstand voltage/pollution degree		12 KV / 3	12 KV / 3
Insulation stripping length (mm)		35	35
Tightening torque nominal/max	Bar (Nm)	-	-
	Cable (Nm)	6 / 9	6 / 9
Width (mm)		32	32
Length (mm)		140	-
Height mounted on TH35/7,5 (mm)		113	-
Height mounted on TH35/15 (mm)		120	-
Height mounted on G32 (mm)		117	-
Height panel mount (mm)		-	108
Length panel mount (mm)		-	173
Fixing distance between centres (mm)		-	158
Insulation material temperature index (EN 60216-1) (°C)		130	130
Plastic material		Polyamide UL94 V0	Polyamide UL94 V0

APPROVALS



ACCESSORIES

Permanent cross connection	(1)	POF/95/... (cod. P095...)	POF/95/... (cod. P095...)
	Rated current (A)	-	-
Mounting rail support	flat for PR/DIN e PR/3	ACI121213 (cod. Z121213)	ACI121213 (cod. Z121213)
	sloped for PR/DIN e PR/3	ACI121024 (cod. Z121024)	ACI121024 (cod. Z121024)
Marking tag		CNU/08/51 (cod. NU0851S)	CNU/08/51 (cod. NU0851S)
		CNU/10/61 (cod. NU1061S)	CNU/10/61 (cod. NU1061S)
End bracket	Snap-fit TH35 and G32	BTU (cod. BT005)	BTU (cod. BT005)
	Snap-fit TH35	BTO (cod. BT007)	BTO (cod. BT007)
	Screw TH35	BT/3 (cod. BT003)	BT/3 (cod. BT003)

- panel mount version - M6 screws (recommended with screwdriver and washer slot)
- possibility of parallel cross connection



CESI 13 ATEX 038 U
I M2 Ex e I Mb
II 2 G Ex e IIC Gb

IECEX CES 13.0012U
Ex e I Mb
Ex e IIC Gb

(1) See chapter accessories for more details



BEIGE VERSION	CODE	GP600	GP610
	TYPE	GPM.150/CC	GPM.150/CC/FIX
GREY VERSION	CODE	GP600GR	GP610GR
	TYPE	GPM.150/CC/GR	GPM.150/CC/FIX/GR

TECHNICAL CHARACTERISTICS

Function/type		feed-through	feed-through
Rated cross-section	(mm ²)	150	150
Connecting capacity	Flexible (mm ²)	50 ÷ 150	50 ÷ 150
	Rigid (mm ²)	35 ÷ 185	35 ÷ 185
Bars and/or cable lugs	Maximum width / bolt (mm)	-	-
Electrical characteristics According to European standard IEC EN 60947-7-1	Max AC/DC Voltage (V)	1000	1000
	Max current with rated cross-section (A)	309	309
	Max current with Max cross-section (A)	440	440
	Section Caliber	B14	B14
Electrical characteristics According to ATEX directive and IEC ex standard	Max AC/DC Voltage (V)	1000	1000
	Max current with rated cross-section (A)	309	309
	Operating Temperature (°C)	-40 ÷ +80	-40 ÷ +80
Rated impulse withstand voltage/pollution degree		12 KV / 3	12 KV / 3
Insulation stripping length	(mm)	35	35
Tightening torque nominal/max	Bar (Nm)	-	-
	Cable (Nm)	10 / 15	10 / 15
Width	(mm)	42	42
Length	(mm)	140	-
Height mounted on TH35/7,5	(mm)	134	-
Height mounted on TH35/15	(mm)	141	-
Height mounted on G32	(mm)	138	-
Height panel mount	(mm)	-	129
Length panel mount	(mm)	-	173
Fixing distance between centres	(mm)	-	158
Insulation material temperature index (EN 60216-1)	(°C)	130	130
Plastic material		Polyamide UL94 V0	Polyamide UL94 V0

APPROVALS



ACCESSORIES

Permanent cross connection	(1)	PFX/150/... (cod. PX15...)	PFX/150/... (cod. PX15...)
	Rated current (A)	-	-
Mounting rail support	flat for PR/DIN e PR/3	ACI121213 (cod. Z121213)	ACI121213 (cod. Z121213)
	sloped for PR/DIN e PR/3	ACI121024 (cod. Z121024)	ACI121024 (cod. Z121024)
Marking tag		CNU/08/51 (cod. NU0851S)	CNU/08/51 (cod. NU0851S)
		CNU/10/61 (cod. NU1061S)	CNU/10/61 (cod. NU1061S)
End bracket	Snap-fit TH35 and G32	BTU (cod. BT005)	BTU (cod. BT005)
	Snap-fit TH35	BTO (cod. BT007)	BTO (cod. BT007)
	Screw TH35	BT/3 (cod. BT003)	BT/3 (cod. BT003)

- panel mount version - M6 screws (recommended with screwdriver and washer slot)
- possibility of parallel cross connection

	CESI 13 ATEX 038 U	IECEX CES 13.0012U
	I M2 Ex e I Mb	Ex e I Mb
	II 2 G Ex e IIC Gb	Ex e IIC Gb

(1) See chapter accessories for more details



BEIGE VERSION	CODE	GP900	GP910
	TYPE	GPM.240/CC	GPM.240/CC/FIX
GREY VERSION	CODE	GP900GR	GP910GR
	TYPE	GPM.240/CC/GR	GPM.240/CC/FIX/GR

TECHNICAL CHARACTERISTICS

Function/type		feed-through	feed-through
Rated cross-section	(mm ²)	240	240
Connecting capacity	Flexible	95 ÷ 240	95 ÷ 240
	Rigid	50 ÷ 300	50 ÷ 300
Bars and/or cable lugs	Maximum width / bolt	-	-
Electrical characteristics According to European standard IEC EN 60947-7-1	Max AC/DC Voltage	1000	1000
	Max current with rated cross-section	415	415
	Max current with Max cross-section	600	600
	Section	Caliber	B16
Electrical characteristics According to ATEX directive and IEC ex standard	Max AC/DC Voltage	1000	1000
	Max current with rated cross-section	415	415
	Operating Temperature	-40 ÷ +80	-40 ÷ +80
Rated impulse withstand voltage/pollution degree		12 KV / 3	12 KV / 3
Insulation stripping length	(mm)	43	43
Tightening torque nominal/max	Bar	-	-
	Cable	14 / 21	14 / 21
Width	(mm)	52	52
Length	(mm)	154	-
Height mounted on TH35/7,5	(mm)	150	-
Height mounted on TH35/15	(mm)	157	-
Height mounted on G32	(mm)	154	-
Height panel mount	(mm)	-	144
Length panel mount	(mm)	-	187
Fixing distance between centres	(mm)	-	172
Insulation material temperature index (EN 60216-1)	(°C)	130	130
Plastic material		Polyamide UL94 V0	Polyamide UL94 V0

APPROVALS



ACCESSORIES			
Permanent cross connection	(1)	PFX/240/... (cod. PX24...)	PFX/240/... (cod. PX24...)
	Rated current	(A)	-
Mounting rail support	flat for PR/DIN e PR/3	ACI121213 (cod. Z121213)	ACI121213 (cod. Z121213)
	sloped for PR/DIN e PR/3	ACI121024 (cod. Z121024)	ACI121024 (cod. Z121024)
Marking tag		CNU/08/51 (cod. NU0851S)	CNU/08/51 (cod. NU0851S)
		CNU/10/61 (cod. NU1061S)	CNU/10/61 (cod. NU1061S)
End bracket	Snap-fit TH35 and G32	BTU (cod. BT005)	BTU (cod. BT005)
	Snap-fit TH35	BTO (cod. BT007)	BTO (cod. BT007)
	Screw TH35	BT/3 (cod. BT003)	BT/3 (cod. BT003)

- panel mount version - M6 screws (recommended with screwdriver and washer slot)
- possibility of parallel cross connection



[1] See chapter accessories for more details

BEIGE VERSION WITH COVER	CODE	GP125		GP135		GP425	
	TYPE		GPM.95/C/BB		GPM.95/C/BB/FIX		GPM.150/C/BB
BEIGE VERSION WITHOUT COVER	CODE	GP120		GP130		GP420	
	TYPE		GPM.95/0/BB		GPM.95/0/BB/FIX		GPM.150/0/BB

TECHNICAL CHARACTERISTICS

Function/type		feed-through	feed-through	feed-through
Rated cross-section	(mm ²)	95	95	150
Connecting capacity	Flexible (mm ²)	-	-	-
	Rigid (mm ²)	-	-	-
Bars and/or cable lugs	Maximum width / bolt (mm)	22 / M8	22 / M8	32 / M10
	Max AC/DC Voltage (V)	1000	1000	1000
Electrical characteristics According to European standard IEC EN 60947-7-1	Max current with rated cross-section (A)	248	248	309
	Max current with Max cross-section (A)	248	248	365
	Section Caliber	-	-	-
Electrical characteristics According to ATEX directive and IEC ex standard	Max AC/DC Voltage (V)	-	-	-
	Max current with rated cross-section (A)	-	-	-
	Operating Temperature (°C)	-	-	-
Rated impulse withstand voltage/pollution degree		12 KV / 3	12 KV / 3	12 KV / 3
Insulation stripping length	(mm)	-	-	-
Tightening torque nominal/max	Bar (Nm)	6 / 9	6 / 9	10 / 15
	Cable (Nm)	-	-	-
Width	(mm)	32	32	42
Length	(mm)	176	-	200
Height mounted on TH35/7,5	(mm)	81	-	81
Height mounted on TH35/15	(mm)	88	-	88
Height mounted on G32	(mm)	85	-	85
Height panel mount	(mm)	-	76	-
Length panel mount	(mm)	-	176	-
Fixing distance between centres	(mm)	-	158	-
Insulation material temperature index (EN 60216-1)	(°C)	130	130	130
Plastic material		Polyamide UL94 V0	Polyamide UL94 V0	Polyamide UL94 V0

APPROVALS



ACCESSORIES				
Permanent cross connection	(1)	POF/95/... (cod. P095...)	POF/95/... (cod. P095...)	PFX/150/... (cod. PX15...)
	Rated current (A)	-	-	-
Mounting rail support	flat for PR/DIN e PR/3	ACI121213 (cod. Z121213)	ACI121213 (cod. Z121213)	ACI121213 (cod. Z121213)
	sloped for PR/DIN e PR/3	ACI121024 (cod. Z121024)	ACI121024 (cod. Z121024)	ACI121024 (cod. Z121024)
Marking tag		CNU/08/51 (cod. NU0851S)	CNU/08/51 (cod. NU0851S)	CNU/08/51 (cod. NU0851S)
		CNU/10/61 (cod. NU1061S)	CNU/10/61 (cod. NU1061S)	CNU/10/61 (cod. NU1061S)
End bracket	Snap-fit TH35 and G32	BTU (cod. BT005)	BTU (cod. BT005)	BTU (cod. BT005)
	Snap-fit TH35	BTO (cod. BT007)	BTO (cod. BT007)	BTO (cod. BT007)
	Screw TH35	BT/3 (cod. BT003)	BT/3 (cod. BT003)	BT/3 (cod. BT003)

SCREW CLAMP

- panel mount version - M6 screws (recommended with screwdriver and washer slot)
- possibility of parallel cross connection



[1] See chapter accessories for more details

BEIGE VERSION WITH COVER	CODE	GP435	GP725	GP735
	TYPE	GPM.150/C/BB/FIX	GPM.240/C/BB	GPM.240/C/BB/FIX
BEIGE VERSION WITHOUT COVER	CODE	GP430	GP720	GP730
	TYPE	GPM.150/O/BB/FIX	GPM.240/O/BB	GPM.240/O/BB/FIX

TECHNICAL CHARACTERISTICS

Function/type		feed-through	feed-through	feed-through
Rated cross-section	(mm ²)	150	240	240
Connecting capacity	Flexible (mm ²)	-	-	-
	Rigid (mm ²)	-	-	-
Bars and/or cable lugs	Maximum width / bolt (mm)	32 / M10	40 / M12	40 / M12
	Max AC/DC Voltage (V)	1000	1000	1000
Electrical characteristics According to European standard IEC EN 60947-7-1	Max current with rated cross-section (A)	309	415	415
	Max current with Max cross-section (A)	365	530	530
	Section Caliber	-	-	-
Electrical characteristics According to ATEX directive and IEC ex standard	Max AC/DC Voltage (V)	-	-	-
	Max current with rated cross-section (A)	-	-	-
	Operating Temperature (°C)	-	-	-
Rated impulse withstand voltage/pollution degree		12 KV / 3	12 KV / 3	12 KV / 3
Insulation stripping length (mm)		-	-	-
Tightening torque nominal/max	Bar (Nm)	10 / 15	14 / 21	14 / 21
	Cable (Nm)	-	-	-
Width (mm)		42	52	52
Length (mm)		-	250	-
Height mounted on TH35/7,5 (mm)		-	89	-
Height mounted on TH35/15 (mm)		-	96	-
Height mounted on G32 (mm)		-	93	-
Height panel mount (mm)		76	-	84
Length panel mount (mm)		200	-	250
Fixing distance between centres (mm)		158	-	172
Insulation material temperature index (EN 60216-1) (°C)		130	130	130
Plastic material		Polyamide UL94 V0	Polyamide UL94 V0	Polyamide UL94 V0

APPROVALS



ACCESSORIES				
Permanent cross connection	(1)	PFX/150/... (cod. PX15...)	PFX/240/... (cod. PX24...)	PFX/240/... (cod. PX24...)
	Rated current (A)	-	-	-
Mounting rail support	flat for PR/DIN e PR/3	ACI121213 (cod. Z121213)	ACI121213 (cod. Z121213)	ACI121213 (cod. Z121213)
	sloped for PR/DIN e PR/3	ACI121024 (cod. Z121024)	ACI121024 (cod. Z121024)	ACI121024 (cod. Z121024)
Marking tag		CNU/08/51 (cod. NU0851S)	CNU/08/51 (cod. NU0851S)	CNU/08/51 (cod. NU0851S)
		CNU/10/61 (cod. NU1061S)	CNU/10/61 (cod. NU1061S)	CNU/10/61 (cod. NU1061S)
End bracket	Snap-fit TH35 and G32	BTU (cod. BT005)	BTU (cod. BT005)	BTU (cod. BT005)
	Snap-fit TH35	BTO (cod. BT007)	BTO (cod. BT007)	BTO (cod. BT007)
	Screw TH35	BT/3 (cod. BT003)	BT/3 (cod. BT003)	BT/3 (cod. BT003)

• bar - bar terminal blocks



BEIGE VERSION	AC100		AC400		AC700	
	ACB.70/BB		ACB.120/BB		ACB.185/BB	
TECHNICAL CHARACTERISTICS	□ ————— □		□ ————— □		□ ————— □	
Function/type	feed-through		feed-through		feed-through	
Rated cross-section (mm ²)	70		120		185	
Connecting capacity	Flexible (mm ²)	10 ÷ 120	25 ÷ 185		25 ÷ 185	
	Rigid (mm ²)	6 ÷ 120	25 ÷ 185		25 ÷ 185	
Bars and/or cable lugs	Maximum width / bolt (mm)	25 / M6	25 / M8		25 / M12	
Electrical characteristics According to European standard IEC EN 60947-7-1	Max AC/DC Voltage (V)	800	800		800	
	Max current with rated cross-section (A)	192	269		353	
	Section	Caliber	-		-	
Rated impulse withstand voltage/pollution degree	8 KV / 3		8 KV / 3		8 KV / 3	
Tightening torque nominal/max (Nm)	3 (key 10 mm)		6 (key 13 mm)		14 (key 19 mm)	
Width (mm)	35		35		35	
Length (mm)	90		100		120	
Height mounted on TH35/7,5 (mm)	-		-		-	
Height mounted on TH35/15 (mm)	-		-		-	
Height mounted on G32 (mm)	45		46		47	
Insulation material temperature index (EN 60216-1) (°C)	130		130		130	
Plastic material	Polyamide UL94 V0		Polyamide UL94 V0		Polyamide UL94 V0	

APPROVALS

ACCESSORIES	AC100	AC400	AC700
Safety cover	PRT/P (cod. PRT01) PRT/G (cod. PRT03)	PRT/P (cod. PRT01) PRT/G (cod. PRT03)	PRT/P (cod. PRT01) PRT/G (cod. PRT03)
Cover support	SPS/1 (cod. SPS01)	SPS/1 (cod. SPS01)	SPS/1 (cod. SPS01)
Marking tag	CNU/08/51 (cod. NU0851S) CNU/10/61 (cod. NU1061S)	CNU/08/51 (cod. NU0851S) CNU/10/61 (cod. NU1061S)	CNU/08/51 (cod. NU0851S) CNU/10/61 (cod. NU1061S)
End bracket	Snap-fit TH35 e G32 BTU (cod. BT005)	BTU (cod. BT005)	BTU (cod. BT005)

Protection: ACB terminal blocks can be protected against direct and/or accidental contacts by means of specific **PRT** covers of different sizes: Small, Medium or Large in transparent and self-extinguishing material. These covers, with a fixed length of 200 mm, correspond to the width of four terminal blocks side-by-side and inserted on **SPS** supports, also made of self-extinguishing material, which enable the protection of one of the two connections of the terminal blocks; the complete protection of the terminal board is obtained using two covers, overlappable.

The **PRT/G** is to be used when the conductors come from the backboard, or in order to protect a connection point not yet connected.

PRT/P+SPS/1 for ACB.70/BB and ACB.120/BB terminal blocks	PRT/P+SPS/3 for ACB.185/BB terminal blocks
PRT/M+SPS/5 for ACB.70 and ACB.120 terminal blocks with clamping collar mounted	PRT/M+SPS/7 for ACB.185 terminal blocks with clamping collar mounted



• bar - bar terminal blocks



BEIGE VERSION	BC100		BC400	
	BCA.70/BB		BCA.120/BB	
TECHNICAL CHARACTERISTICS	□ ————— □		□ ————— □	
Function/type	feed-through		feed-through	
Rated cross-section	(mm ²)	70	120	
Connecting capacity	Flexible	(mm ²)	10 ÷ 120	
	Rigid	(mm ²)	6 ÷ 120	
Bars and/or cable lugs	Maximum width / bolt	(mm)	25 / M6	
Electrical characteristics According to European standard IEC EN 60947-7-1	Max AC/DC Voltage	(V)	800	
	Max current with rated cross-section	(A)	192	
	Section	Caliber	-	
Rated impulse withstand voltage/pollution degree		3kV / 3	3kV / 3	
Tightening torque nominal/max	(Nm)	3 (key 10 mm)	6 (key 13 mm)	
Width	(mm)	35	35	
Length	(mm)	90	100	
Height mounted on G32	(mm)	41	42	
Height mounted on TH35/7,5	(mm)	49	50	
Height mounted on TH35/15	(mm)	-	-	
Insulation material temperature index (EN 60216-1)	(°C)	130	130	
Plastic material		Polyamide UL94 V0	Polyamide UL94 V0	

APPROVALS

ACCESSORIES			
Safety cover		PRT/P (cod. PRT01)	PRT/P (cod. PRT01)
		PRT/G (cod. PRT03)	PRT/G (cod. PRT03)
Cover support		SPS/1 (cod. SPS01)	SPS/1 (cod. SPS01)
Marking tag		CNU/08/51 (cod. NU0851S)	CNU/08/51 (cod. NU0851S)
		CNU/10/61 (cod. NU1061S)	CNU/10/61 (cod. NU1061S)
End bracket	Snap-fit TH35 e G32	BTU (cod. BT005)	BTU (cod. BT005)

- stud connection, for cable lugs



BEIGE VERSION		MB100	MB200
		MBL.50/6	MBL.95/8
TECHNICAL CHARACTERISTICS			
Function/type		for cable lugs	for cable lugs
Rated cross-section	(mm ²)	50	95
Connecting capacity	Flexible (mm ²)	30 ÷ 50	30 ÷ 95
	Rigid (mm ²)	30 ÷ 70	30 ÷ 120
Stud diameter / key / locking bolt wrench		M10 / M13 / M19	M 8 / M 13 / M 19
Electrical characteristics According to European standard IEC EN 60947-7-1	Max AC/DC Voltage (V)	800	800
	Max current with rated cross-section (A)	150	232
	Section (Caliber)	-	-
Electrical characteristics According to UL	Max AC/DC Voltage (V)	600	600
	Max current with rated cross-section (A)	150	200
	Section Min - Max (AWG)	-	-
Rated impulse withstand voltage/pollution degree		8kV / 3	8 kV / 3
Maximum connectable width	(mm)	30	30
Max lug overlapping connection height	(mm)	15.3	13
Tightening torque	(Nm)	3	6
Width	(mm)	35	35
Length	(mm)	39	39
Height mounted on G32	(mm)	79	79
Insulation material temperature index (EN 60216-1)	(°C)	130	130
Plastic material		polyamide UL94V-0	polyamide UL94V-0

APPROVALS



ACCESSORIES			
Partition		DUS/1 (cod. DUS01)	DUS/1 (cod. DUS01)
Cover support		SPS/5 (cod. SPS05)	SPS/5 (cod. SPS05)
Safety cover		PRT/P (cod. PRT01)	PRT/P (cod. PRT01)
Marking tag		CNU/08/51 (cod. NU0851S)	CNU/08/51 (cod. NU0851S)
		CNU/10/61 (cod. NU1061S)	CNU/10/61 (cod. NU1061S)
End bracket	Snap-fit TH35 e G32	BTU (cod. BT005)	BTU (cod. BT005)

Stud terminal blocks for the terminal wire or bar strain clamp with max. width 30 mm, to be mounted on PR/DIN mounting rail. It is advisable to use **DUS/1** or **DUS/3** barriers to guarantee the insulation distance between different phases.

If accident prevention cover of the terminal board becomes necessary, the insulation function would be performed by the **SPS/5** supports of the cover itself.



- stud connection, for cable lugs



BEIGE VERSION		MB300	MB400
		MBL.120/10	MBL.150/12
TECHNICAL CHARACTERISTICS			
Function/type		for cable lugs	for cable lugs
Rated cross-section	(mm ²)	120	150
Connecting capacity	Flexible (mm ²)	30 ÷ 120	30 ÷ 150
	Rigid (mm ²)	30 ÷ 150	30 ÷ 185
Stud diameter / key / locking bolt wrench		M 10 / M 13 / M 19	M 12 / M 19 / M 19
Electrical characteristics According to European standard IEC EN 60947-7-1	Max AC/DC Voltage (V)	800	800
	Max current with rated cross-section (A)	269	309
	Section (Caliber)	-	-
Electrical characteristics According to UL	Max AC/DC Voltage (V)	600	600
	Max current with rated cross-section (A)	230	285
	Section Min - Max (AWG)	-	-
Rated impulse withstand voltage/pollution degree		8 kV / 3	8 kV / 3
Maximum connectable width	(mm)	30	30
Max lug overlapping connection height	(mm)	13	15.8
Tightening torque	(Nm)	10	14
Width	(mm)	35	35
Length	(mm)	39	39
Height mounted on G32	(mm)	90	90
Insulation material temperature index (EN 60216-1)	(°C)	130	130
Plastic material		polyamide UL94V-0	polyamide UL94V-0

APPROVALS		
-----------	--	--

ACCESSORIES			
Partition		DUS/3 (cod. DUS03)	DUS/3 (cod. DUS03)
Cover support		SPS/5 (cod. SPS05)	SPS/5 (cod. SPS05)
Safety cover		PRT/P (cod. PRT01)	PRT/P (cod. PRT01)
Marking tag		CNU/08/51 (cod. NU0851S)	CNU/08/51 (cod. NU0851S)
		CNU/10/61 (cod. NU1061S)	CNU/10/61 (cod. NU1061S)
End bracket	Snap-fit TH35 e G32	BTU (cod. BT005)	BTU (cod. BT005)



CESI 02 ATEX 061 U
I M2 Ex eb I Mb
II 2 G Ex eb IIC Gb

IECEX CES 09.0010U
Ex eb I Mb
Ex eb IIC Gb

YELLOW/GREEN VERSION

CODE
TYPE

TO910

TE0.2

CE110

CBE.2

T0430

TE0.4

TECHNICAL CHARACTERISTICS

Function/type		Earth terminal block	Earth terminal block	Earth terminal block
Rated cross-section	(mm ²)	2.5	2.5	4
Connecting capacity	Flexible (mm ²)	0.2 - 4	0.2 - 4	0.2 - 6
	Rigid (mm ²)	0.2 - 4	0.2 - 4	0.2 - 6
	Max. flexible with ferrule - ferrule type (mm ²)	2.5 - WP25/14	2.5 - WP25/14	4 - WP40/16
Electrical characteristics According to European standard IEC EN 60947-7-2	Max AC/DC Voltage (V)	-	-	-
	Max current with rated cross-section (A)	-	-	-
Electrical characteristics According to UL	Section (Caliber)	A3	A3	A4
	Max AC/DC Voltage (V)	-	-	-
	Max current with rated cross-section (A)	-	-	-
Electrical characteristics According to ATEX directive and IEC ex standard	Section Min - Max (AWG)	20 - 14	20 - 14	20 - 12
	Tightening torque (lb.in)	5.5	5.5	5.5
	Max AC/DC Voltage (V)	-	-	-
Rated impulse withstand voltage/pollution degree	Max current with rated cross-section (A)	24	-	32
	Operating Temperature (°C)	-40 ÷ +110	-	-40 ÷ +110
Rated impulse withstand voltage/pollution degree		8 KV / 3	8 KV / 3	8 KV / 3
Insulation stripping length (mm)		12	8	14
Tightening torque value (test / max) (Nm)		0.4 / 0.8	0.4 / 0.5	0.5 / 1.2
Width (mm)		50	50	50
Length (mm)		5.5	5	6.5
Height mounted on TH35/7.5 (mm)		47	52	52
Height mounted on TH35/15 (mm)		55	60	60
Height mounted on G32 (mm)		-	56	-
Insulation material temperature index (EN 60216-1) (°C)		130	130	130
Plastic material		Polyamide UL94V-0	Polyamide UL94V-0	Polyamide UL94V-0

APPROVALS



ACCESSORIES

End section	green	TE0.2/PT (cod. T0911)	CBR/PT (cod. CR111)	TE0.4/PT (cod. T0431)
Numbering strip		-	CNU/08/51 (cod. NU0851S)	-
Marking tag		CNU/08/51 (cod. NU0851S)	CNU/08/51 (cod. NU0851S)	CNU/08/51 (cod. NU0851S)
		CNU/10/61 (cod. NU1061S)	CNU/10/61 (cod. NU1061S)	CNU/10/61 (cod. NU1061S)
End bracket	Snap-fit TH35 e G32	BT/3 (cod. BT003)	BT/3 (cod. BT003)	BT/3 (cod. BT003)
	Snap-fit TH35	BTO (cod. BT007)	BTO (cod. BT007)	BTO (cod. BT007)
	Screw TH35	BTU (cod. BT005)	BTU (cod. BT005)	BTU (cod. BT005)
	Screw G32	-	BT/DIN/PO (cod. BT001)	-

MAXIMUM SHORT-TIME WITHSTAND CURRENTS ALLOCATED TO THE RAIL PROFILE

Rail profile	Material	Equivalent E-cu cross-section mm ²	Short-time withstand current 1 s kA	Thermal rated current of a PEN busbar A
Top hat rail IEC 60715/TH 15 - 5.5	Steel	10	1.2	-
	Copper	25	3	101
	Aluminium	16	1.92	76
Top hat rail IEC 60715/TH 35 - 7.5	Steel	16	1.92	-
	Copper	50	6	150
	Aluminium	35	4.2	125
Top hat rail IEC 60715/TH 35 - 15	Steel	50	6	-
	Copper	150	18	309
	Aluminium	95	11.4	232



CESI 02 ATEX 061 U
I M2 Ex eb I Mb
II 2 G Ex eb IIC Gb

IECEX CES 09.0010U
Ex eb I Mb
Ex eb IIC Gb

YELLOW/GREEN VERSION	CODE	TE400	T0110	T0500
	TYPE	TED.4	TE.6/0	TE.10/0

TECHNICAL CHARACTERISTICS				
Function/type		Earth terminal block	Earth terminal block	Earth terminal block
Rated cross-section	(mm ²)	4	6	10
Connecting capacity	Flexible (mm ²)	0.2 - 6	0.5 - 10	0.5 - 16
	Rigid (mm ²)	0.2 - 6	0.5 - 10	0.5 - 16
	Max. flexible with ferrule - ferrule type (mm ²)	4 - WP40/16	6 - WP60/20	10 - WP100/21
Electrical characteristics According to European standard IEC EN 60947-7-2	Max AC/DC Voltage (V)	-	-	-
	Max current with rated cross-section (A)	-	-	-
	Section (Caliber)	A4	A5	B6
Electrical characteristics According to UL	Max AC/DC Voltage (V)	-	-	-
	Max current with rated cross-section (A)	-	-	-
	Section Min - Max (AWG)	20 - 12	20 - 8	20 - 8
Electrical characteristics According to ATEX directive and IEC ex standard	Tightening torque (lb.in)	5.5	13.3	13.3
	Max AC/DC Voltage (V)	-	-	-
	Max current with rated cross-section (A)	-	41	57
Operating Temperature (°C)	-40 ÷ +80	-40 ÷ +110	-40 ÷ +110	
Rated impulse withstand voltage/pollution degree		8 KV / 3	8 KV / 3	8 KV / 3
Insulation stripping length	(mm)	10	12	13
Tightening torque value (test / max)	(Nm)	0.5 / 1.2	0.8 / 1.4	1.2 / 1.9
Width	(mm)	50	47	47
Length	(mm)	6.5	8	10
Height mounted on TH35/7.5	(mm)	-	52	55
Height mounted on TH35/15	(mm)	-	60	63
Height mounted on G32	(mm)	56	-	-
Insulation material temperature index (EN 60216-1)	(°C)	130	130	130
Plastic material		Polyamide UL94V-0	Polyamide UL94V-0	Polyamide UL94V-0

APPROVALS

ACCESSORIES

End section	green	TE0.4/PT (cod. T0431)	-	-
Numbering strip		-	-	-
Marking tag		CNU/08/51 (cod. NU0851S)	CNU/08/51 (cod. NU0851S)	CNU/08/51 (cod. NU0851S)
		CNU/10/61 (cod. NU1061S)	CNU/10/61 (cod. NU1061S)	CNU/10/61 (cod. NU1061S)
End bracket	Snap-fit TH35 e G32	BT/3 (cod. BT003)	BT/3 (cod. BT003)	BT/3 (cod. BT003)
	Snap-fit TH35	BTO (cod. BT007)	BTO (cod. BT007)	BTO (cod. BT007)
	Screw TH35	BTU (cod. BT005)	BTU (cod. BT005)	BTU (cod. BT005)
	Screw G32	BT/DIN/PO (cod. BT001)	-	-

MAXIMUM SHORT-TIME WITHSTAND CURRENTS ALLOCATED TO THE RAIL PROFILE

Rail profile	Material	Equivalent E-cu cross-section mm ²	Short-time withstand current 1s kA	Thermal rated current of a PEN busbar A
Top hat rail IEC 60715/TH 15 - 5.5	Steel	10	1.2	-
	Copper	25	3	101
	Aluminium	16	1.92	76
Top hat rail IEC 60715/TH 35 - 7.5	Steel	16	1.92	-
	Copper	50	6	150
	Aluminium	35	4.2	125
Top hat rail IEC 60715/TH 35 - 15	Steel	50	6	-
	Copper	150	18	309
	Aluminium	95	11.4	232



CESI 02 ATEX 061 U
I M2 Ex eb I Mb
II 2 G Ex eb IIC Gb

IECEx CES 09.0010U
Ex eb I Mb
Ex eb IIC Gb



YELLOW/GREEN VERSION	CODE	TO210	TO310	TE110
	TYPE	TE.16/0	TE.50/0	TE.6/D

TECHNICAL CHARACTERISTICS				
Function/type		Earth terminal block	Earth terminal block	Earth terminal block
Rated cross-section	(mm ²)	16	50	6
Connecting capacity	Flexible (mm ²)	0.5 - 25	1.5 - 50	0.5 - 10
	Rigid (mm ²)	0.5 - 25	1 - 70	0.5 - 10
	Max. flexible with ferrule - ferrule type (mm ²)	16 - WP160/22	50 - WP500/40	6 - WP60/20
Electrical characteristics According to European standard IEC EN 60947-7-2	Max AC/DC Voltage (V)	-	-	-
	Max current with rated cross-section (A)	76	150	-
	Section (Caliber)	B7	B9	A5
Electrical characteristics According to UL	Max AC/DC Voltage (V)	-	-	-
	Max current with rated cross-section (A)	-	-	-
	Section Min - Max (AWG)	20 - 3	16 - 1	20 - 8
Electrical characteristics According to ATEX directive and IEC ex standard	Tightening torque (lb.in)	13.3	33.2	13.3
	Max AC/DC Voltage (V)	-	-	-
	Max current with rated cross-section (A)	76	150	41
Rated impulse withstand voltage/pollution degree	Operating Temperature (°C)	-40 ÷ +110	-40 ÷ +110	-40 ÷ +110
		8 KV / 3	8 KV / 3	8 KV / 3
Insulation stripping length	(mm)	13	17	12
Tightening torque value (test / max)	(Nm)	1.8 / 3	2.5 / 5	0.8 / 1.4
Width	(mm)	47	57	42
Length	(mm)	12	18	8
Height mounted on TH35/7.5	(mm)	56	62	-
Height mounted on TH35/15	(mm)	64	70	-
Height mounted on G32	(mm)	-	-	53
Insulation material temperature index (EN 60216-1)	(°C)	130	130	130
Plastic material		Polyamide UL94V-0	Polyamide UL94V-0	Polyamide UL94V-0

APPROVALS

ACCESSORIES

End section	green	-	-	-
Numbering strip		-	-	-
Marking tag		CNU/08/51 (cod. NU0851S)	CNU/08/51 (cod. NU0851S)	CNU/08/51 (cod. NU0851S)
		CNU/10/61 (cod. NU1061S)	CNU/10/61 (cod. NU1061S)	CNU/10/61 (cod. NU1061S)
End bracket	Snap-fit TH35 e G32	BT/3 (cod. BT003)	BT/3 (cod. BT003)	BT/3 (cod. BT003)
	Snap-fit TH35	BTO (cod. BT007)	BTO (cod. BT007)	BTO (cod. BT007)
	Screw TH35	BTU (cod. BT005)	BTU (cod. BT005)	BTU (cod. BT005)
	Screw G32	-	-	BT/DIN/PO (cod. BT001)

MAXIMUM SHORT-TIME WITHSTAND CURRENTS ALLOCATED TO THE RAIL PROFILE				
Rail profile	Material	Equivalent E-cu cross-section mm ²	Short-time withstand current 1s kA	Thermal rated current of a PEN busbar A
Top hat rail IEC 60715/TH 15 - 5.5	Steel	10	1.2	-
	Copper	25	3	101
	Aluminium	16	1.92	76
G32 type mounting rail IEC 60715/G32	Steel	35	4.2	-
	Copper	120	14.4	269
	Aluminium	70	8.4	192
Top hat rail IEC 60715/TH 35 - 7.5	Steel	16	1.92	-
	Copper	50	6	150
	Aluminium	35	4.2	125
Top hat rail IEC 60715/TH 35 - 15	Steel	50	6	-
	Copper	150	18	309
	Aluminium	95	11.4	232



CESI 02 ATEX 061 U
I M2 Ex eb I Mb
II 2 G Ex eb IIC Gb

IECEx CES 09.0010U
Ex eb I Mb
Ex eb IIC Gb

YELLOW/GREEN VERSION		CODE	TE500	TE210	TE310
		TYPE	TE.10/D	TE.16/D	TE.50/D
TECHNICAL CHARACTERISTICS					
Function/type			Earth terminal block	Earth terminal block	Earth terminal block
Rated cross-section		(mm ²)	10	16	50
Connecting capacity	Flexible	(mm ²)	0.5 - 16	0.5 - 25	1.5 - 50
	Rigid	(mm ²)	0.5 - 16	0.5 - 25	1 - 70
	Max. flexible with ferrule - ferrule type	(mm ²)	10 - WP100/21	16 - WP160/22	50 - WP500/40
Electrical characteristics According to European standard IEC EN 60947-7-2					
Max AC/DC Voltage		(V)	-	-	-
Max current with rated cross-section		(A)	-	76	150
Section		Caliber	B6	B7	B9
Electrical characteristics According to UL					
Max AC/DC Voltage		(V)	-	-	-
Max current with rated cross-section		(A)	-	-	-
Section Min - Max		(AWG)	20 - 8	20 - 3	16 - 1
Tightening torque		(lb.in)	13.3	13.3	33.2
Electrical characteristics According to ATEX directive and IEC ex standard					
Max AC/DC Voltage		(V)	-	-	-
Max current with rated cross-section		(A)	57	76	150
Operating Temperature		(°C)	-40 ÷ +110	-40 ÷ +110	-40 ÷ +110
Rated impulse withstand voltage/pollution degree			8 KV / 3	8 KV / 3	8 KV / 3
Insulation stripping length		(mm)	13	13	17
Tightening torque value (test / max)		(Nm)	1.2 / 1.9	1.8 / 3	2.5 / 5
Width		(mm)	44	46.5	57
Length		(mm)	10	12	18
Height mounted on TH35/7.5		(mm)	-	-	-
Height mounted on TH35/15		(mm)	-	-	-
Height mounted on G32		(mm)	56	57.5	63
Insulation material temperature index (EN 60216-1)		(°C)	130	130	130
Plastic material			Polyamide UL94V-0	Polyamide UL94V-0	Polyamide UL94V-0
APPROVALS					
ACCESSORIES					
End section		green	-	-	-
Numbering strip			-	-	-
Marking tag			CNU/08/51 (cod. NU0851S) CNU/10/61 (cod. NU1061S)	CNU/08/51 (cod. NU0851S) CNU/10/61 (cod. NU1061S)	CNU/08/51 (cod. NU0851S) CNU/10/61 (cod. NU1061S)
End bracket	Snap-fit TH35 e G32		BT/3 (cod. BT003)	BT/3 (cod. BT003)	BT/3 (cod. BT003)
	Snap-fit TH35		BTO (cod. BT007)	BTO (cod. BT007)	BTO (cod. BT007)
	Screw TH35		BTU (cod. BT005)	BTU (cod. BT005)	BTU (cod. BT005)
	Screw G32		BT/DIN/PO (cod. BT001)	BT/DIN/PO (cod. BT001)	BT/DIN/PO (cod. BT001)

MAXIMUM SHORT-TIME WITHSTAND CURRENTS ALLOCATED TO THE RAIL PROFILE

Rail profile	Material	Equivalent E-cu cross-section mm ²	Short-time withstand current 1s kA	Thermal rated current of a PEN busbar A
Top hat rail IEC 60715/TH 15 - 5.5	Steel	10	1.2	-
	Copper	25	3	101
	Aluminium	16	1.92	76
G32 type mounting rail IEC 60715/G32	Steel	35	4.2	-
	Copper	120	14.4	269
	Aluminium	70	8.4	192
Top hat rail IEC 60715/TH 35 - 7.5	Steel	16	1.92	-
	Copper	50	6	150
	Aluminium	35	4.2	125
Top hat rail IEC 60715/TH 35 - 5.5	Steel	50	6	-
	Copper	150	18	309
	Aluminium	95	11.4	232



CESI 14 ATEX 035 U
I M2 Ex e I Mb
II 2 G Ex e IIC Gb

IECEx CES 14.0021U
Ex e I Mb
Ex e IIC Gb

(1) See chapter accessories for more details

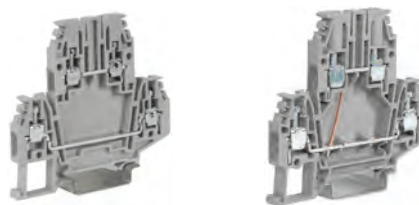

GREY VERSION	CODE	DB100GR	DBC.2/GR	DB117GR	DBC.2/CI/GR
	TYPE				
BEIGE VERSION	CODE	DB100		DB117	
	TYPE		DBC.2		DBC.2/CI
BLUE VERSION	CODE	DB200			
	TYPE		DBC.2 (EX)I		

TECHNICAL CHARACTERISTICS

Function/type		2 levels	2 levels with internal connection
Rated cross-section	(mm ²)	2.5	2.5
Connecting capacity	Flexible (mm ²)	0.2 - 4	0.2 - 4
	Rigid (mm ²)	0.2 - 4	0.2 - 4
	Max. flexible with ferrule - ferrule type (mm ²)	2.5 - WP25/14	2.5 - WP25/14
Electrical characteristics According to European standard IEC EN 60947-7-1	Max AC/DC Voltage (V)	630	630
	Max current with rated cross-section (A)	24	24
	Section Caliber	A3	A3
Electrical characteristics According to UL	Max AC/DC Voltage (V)	600	600
	Max current with rated cross-section (A)	20	20
	Section Min-Max (AWG)	28 - 12	28 - 12
	Tightening torque (lb.in)	8	8
Electrical characteristics According to ATEX directive and IEC ex standard	Max AC/DC Voltage (V)	400	-
	Max current with rated cross-section (A)	24	-
	Operating temperature (°C)	-40 ÷ +80	-
Rated impulse withstand voltage/pollution degree		8 KV / 3	8 KV / 3
Insulation stripping length	(mm)	9	9
tightening torque value (test / max)	(Nm)	0.4 / 0.8	0.4 / 0.8
Width	(mm)	70	70
Length	(mm)	5	5
Height mounted on TH35/7,5	(mm)	66	66
Height mounted on TH35/15	(mm)	74	74
Height mounted on G32	(mm)	-	-
Insulation material temperature index (EN 60216-1)	(°C)	130	130
Plastic material		Polyamide UL94V-0	Polyamide UL94V-0



APPROVALS

ACCESSORIES

End section	Grey	DBC/PT/GR (cod. DB101GR)	DBC/PT/GR (cod. DB101GR)
	Beige	DBC/PT (cod. DB101)	DBC/PT (cod. DB101)
	Blue	DBC/PT (Ex)I (cod. DB201)	DBC/PT (Ex)I (cod. DB201)
	Thickness (mm)	1.5	1.5
Cross connection	PTC or other versions (1)	PTC/2/... (cod. PTC02...)	PTC/2/... (cod. PTC02...)
	PTP version (1)	PTP/2/... (cod. PTP02...)	PTP/2/... (cod. PTP02...)
	Rated current / Rated current ATEX applications (A)	24 / 21	24 / 21
Cross connection identification strip	green	PTC/SP (cod. PTC0990)	PTC/SP (cod. PTC0990)
Switchable cross connection		-	-
Multiple common bar	250 mm	-	-
Shunting screw and sleeve	standard / Ex e version	-	-
	internal jumper	-	-
	internal jumper + external jumper	-	-
Coloured partition	red	DFU/7/R (cod. DU07R)	DFU/7/R (cod. DU07R)
Cross connection barred (upper level)	red	DFM/800 (cod. DF800) - DFM/900 (cod. DF900)	DFM/800 (cod. DF800) - DFM/900 (cod. DF900)
Cross connection barred (lower level)	red	DFM/500 (cod. DF500)	DFM/500 (cod. DF500)
Cross connection barrier	red	-	-
Test plug socket		-	-
Test plug		-	-
Modular test plug		-	-
Numbering strip		CNU/8/51 (cod. NU0851S)	CNU/8/51 (cod. NU0851S)
Single marking tag		CNU/8/51 (cod. NU0851S)	CNU/8/51 (cod. NU0851S)
		CNU/8/51 (cod. NU0851S)	CNU/8/51 (cod. NU0851S)
Warning plate	on adjacent terminal blocks	-	-
Cover for cross-connection		-	-
End bracket	Snap-fit TH35 and G32	BTU (cod. BT005)	BTU (cod. BT005)
	Snap-fit TH35	BTO (cod. BT007)	BTO (cod. BT007)
	Screw TH35	-	-
	Screw G32	-	-

IMQ 17 ATEX 001 U
I M2 Ex eb I Mb
II 2 G Ex eb IIC Gb

IECEX IMQ 17.0001U
Ex eb I Mb
Ex eb IIC Gb

(1) See chapter accessories for more details

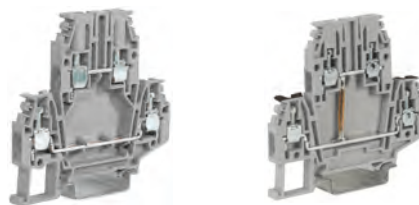

GREY VERSION	CODE	DB400GR	DBC.4/GR	DB417GR	DBC.4/CI/GR
	TYPE				
BEIGE VERSION	CODE				
	TYPE				
BLUE VERSION	CODE	DB500	DBC.4 (EX)I	DB517	DBC.4/CI (EX)I
	TYPE				

TECHNICAL CHARACTERISTICS

Function/type		2 levels	2 levels with internal connection
Rated cross-section	(mm ²)	4	4
Connecting capacity	Flexible (mm ²)	0.2 – 6	0.2 – 6
	Rigid (mm ²)	0.2 – 6	0.2 – 6
	Max. flexible with ferrule - ferrule type (mm ²)	4 - WP40/16	4 - WP40/16
Electrical characteristics According to European standard IEC EN 60947-7-1	Max AC/DC Voltage (V)	630	630
	Max current with rated cross-section (A)	32	32
	Section Caliber	A4	A4
Electrical characteristics According to UL	Max AC/DC Voltage (V)	600	600
	Max current with rated cross-section (A)	30	30
	Section Min-Max (AWG)	20 - 10	20 - 10
	Tightening torque (lb.in)	4.4	4.4
Electrical characteristics According to ATEX directive and IEC ex standard	Max AC/DC Voltage (V)	400	-
	Max current with rated cross-section (A)	28	-
	Operating temperature (°C)	-40 ÷ +80	-
Rated impulse withstand voltage/pollution degree		8 KV / 3	8 KV / 3
Insulation stripping length (mm)		9	9
tightening torque value (test / max) (Nm)		0,5 / 1	0,5 / 1
Width (mm)		70	70
Length (mm)		6	6
Height mounted on TH35/7,5 (mm)		66	66
Height mounted on TH35/15 (mm)		74	74
Height mounted on G32 (mm)		-	-
Insulation material temperature index (EN 60216-1) (°C)		130	130
Plastic material		Polyamide UL94V-0	Polyamide UL94V-0

APPROVALS

ACCESSORIES

End section	Grey	DBC.4/PT/GR (cod. DB401GR)	DBC.4/PT/GR (cod. DB401GR)
	Beige	-	-
	Blue	DBC.4/PT (Ex)I (cod. DB402)	DBC.4/PT (Ex)I (cod. DB402)
	Thickness (mm)	1.5	1.5
Cross connection	PTC or other versions (1)	PTC/4/... (cod. PTC04...)	PTC/4/... (cod. PTC04...)
	PTP version (1)	PTP/4/... (cod. PTP04...)	PTP/4/... (cod. PTP04...)
	Rated current / Rated current ATEX applications (A)	32 / 25	32 / 25
Cross connection identification strip	green	PTC/SP (cod. PTC0990)	PTC/SP (cod. PTC0990)
Switchable cross connection		-	-
Multiple common bar	250 mm	-	-
Shunting screw and sleeve	standard / Ex e version	-	-
	internal jumper	-	-
	internal jumper + external jumper	-	-
Coloured partition	red	DFU/7/R (cod. DU07R)	DFU/7/R (cod. DU07R)
Cross connection barred (upper level)	red	DFM/800 (cod. DF800) - DFM/900 (cod. DF900)	DFM/800 (cod. DF800) - DFM/900 (cod. DF900)
Cross connection barred (lower level)	red	DFM/500 (cod. DF500)	DFM/500 (cod. DF500)
Cross connection barrier	red	-	-
Test plug socket		-	-
Test plug		-	-
Modular test plug		-	-
Numbering strip		CNU/8/51 (cod. NU0851S)	CNU/8/51 (cod. NU0851S)
Single marking tag		CNU/8/51 (cod. NU0851S)	CNU/8/51 (cod. NU0851S)
		CNU/8/51 (cod. NU0851S)	CNU/8/51 (cod. NU0851S)
Warning plate	on adjacent terminal blocks	-	-
Cover for cross-connection		-	-
End bracket	Snap-fit TH35 and G32	BTU (cod. BT005)	BTU (cod. BT005)
	Snap-fit TH35	BTO (cod. BT007)	BTO (cod. BT007)
	Screw TH35	BT/3 (cod. BT003)	BT/3 (cod. BT003)
	Screw G32	-	-



CESI 03 ATEX 162 U
I M2 Ex eb I Mb
II 2 G Ex eb IIC Gb

IECEx CES 11.0007U
Ex eb I Mb
Ex eb IIC Gb

(1) See chapter accessories for more details

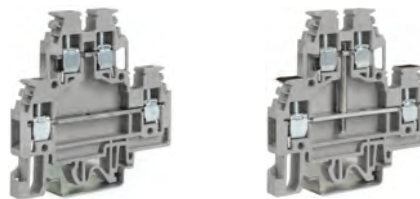

GREY VERSION	CODE	DS100GR	DS117GR
	TYPE	DAS.4/GR	DAS.4/CI/GR
BEIGE VERSION	CODE	DS100	DS117
	TYPE	DAS.4	DAS.4/CI
BLUE VERSION	CODE	DS200	DS217
	TYPE	DAS.4 (EXII)	DAS.4/CI (EXII)

TECHNICAL CHARACTERISTICS

Function/type		2 levels	2 levels with internal jumper mounted
Rated cross-section	(mm ²)	4	4
Connecting capacity	Flexible (mm ²)	0.2 - 6	0.2 - 6
	Rigid (mm ²)	0.2 - 6	0.2 - 6
	Max. flexible with ferrule - ferrule type (mm ²)	4 - WP40/16	4 - WP40/16
Electrical characteristics According to European standard IEC EN 60947-7-1	Max AC/DC Voltage (V)	630	630
	Max current with rated cross-section (A)	30	30
	Section Caliber	A4	A4
Electrical characteristics According to UL	Max AC/DC Voltage (V)	600	600
	Max current with rated cross-section (A)	20	20
	Section Min-Max (AWG)	20 - 10	20 - 10
	Tightening torque (lb.in)	8.9	8.9
Electrical characteristics According to ATEX directive and IEC ex standard	Max AC/DC Voltage (V)	400	-
	Max current with rated cross-section (A)	28	-
	Operating temperature (°C)	-40 ÷ +110	-
Rated impulse withstand voltage/pollution degree		8 KV / 3	8 KV / 3
Insulation stripping length	(mm)	9	9
tightening torque value (test / max)	(Nm)	0.5 / 1.2	0.5 / 1.2
Width	(mm)	64	64
Length	(mm)	6	6
Height mounted on TH35/7,5	(mm)	62	62
Height mounted on TH35/15	(mm)	70	70
Height mounted on G32	(mm)	66	66
Insulation material temperature index (EN 60216-1)	(°C)	130	130
Plastic material		Polyamide UL94V-0	Polyamide UL94V-0



APPROVALS

ACCESSORIES

End section	Grey	DAS/PT/GR (cod. DS101GR)	DAS/PT/GR (cod. DS101GR)
	Beige	DAS/PT (cod. DS101)	DAS/PT (cod. DS101)
	Blue	DAS/PT (ExII) (cod. DS201)	DAS/PT (ExII) (cod. DS201)
	Thickness (mm)	1.5	1.5
Cross connection	PTC or other versions (1)	PM/.../... (cod. PM...)	PM/.../... (cod. PM...)
	PTP version (1)	-	-
	Rated current / Rated current ATEX applications (A)	30 / -	30 / -
Cross connection identification strip	green	-	-
Switchable cross connection		POS/43 (cod.POS43)	POS/43 (cod.POS43)
Multiple common bar	250 mm	PMP/58 (cod.PMP58)	PMP/58 (cod.PMP58)
Shunting screw and sleeve	standard / Ex e version	CPM/01 (cod. CPM01) - CPX/01 (cod. CPX01)	CPM/01 (cod. CPM01) - CPX/01 (cod. CPX01)
	internal jumper	DAS/VCI (cod. DS107)	-
	internal jumper + external jumper	DAS/VCE (cod. DS108)	DAS/VCE (cod. DS108)
Coloured partition	red	DFU/7/R (cod. DU07R)	DFU/7/R (cod. DU07R)
Cross connection barred (upper level)	red	-	-
Cross connection barred (lower level)	red	-	-
Cross connection barrier	red	-	-
Test plug socket		PSD/A (cod. PD001)	PSD/A (cod. PD001)
Test plug		SDD/1 (cod. DD001)	SDD/1 (cod. DD001)
Modular test plug		-	-
Numbering strip		CNU/8/61 (cod. NU0861S)	CNU/8/61 (cod. NU0861S)
Single marking tag		CNU/8/61 (cod. NU0861S)	CNU/8/61 (cod. NU0861S)
Warning plate	on adjacent terminal blocks	-	-
Cover for cross-connection		PRP/5 (cod. PRP05)	PRP/5 (cod. PRP05)
End bracket	Snap-fit TH35 and G32	BTU (cod. BT005)	BTU (cod. BT005)
	Snap-fit TH35	BTO (cod. BT007)	BTO (cod. BT007)
	Screw TH35	BT/3 (cod. BT003)	BT/3 (cod. BT003)
	Screw G32	BT/DIN/PO (cod. BT001)	BT/DIN/PO (cod. BT001)



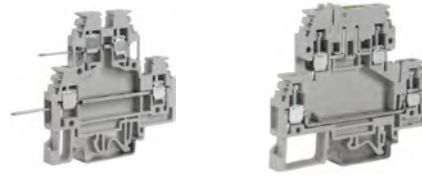

(1) See chapter accessories for more details

GREY VERSION	CODE	DS110GR	DS400GR
	TYPE	DAS.4/SS/GR	DSS.4/GR
BEIGE VERSION	CODE	DS110	DS400
	TYPE	DAS.4/SS	DSS.4
BLUE VERSION	CODE		
	TYPE		

TECHNICAL CHARACTERISTICS

Function/type		2 levels with solder lugs	2 levels disconnect
Rated cross-section	(mm ²)	4	4
Connecting capacity	Flexible (mm ²)	0.2 - 6	0.2 - 6
	Rigid (mm ²)	0.2 - 6	0.2 - 6
	Max. flexible with ferrule - ferrule type (mm ²)	4 - WP40/16	4 - WP40/16
Electrical characteristics According to European standard IEC EN 60947-7-1	Max AC/DC Voltage (V)	320-500	400
	Max current with rated cross-section (A)	20	24 upper level /32 lower level
	Section Caliber	A4	A4
Electrical characteristics According to UL	Max AC/DC Voltage (V)	-	300
	Max current with rated cross-section (A)	-	24 upper level /32 lower level
	Section Min-Max (AWG)	-	26 - 10
	Tightening torque (lb.in)	-	4.4
Electrical characteristics According to ATEX directive and IEC ex standard	Max AC/DC Voltage (V)	-	-
	Max current with rated cross-section (A)	-	-
	Operating temperature (°C)	-	-
Rated impulse withstand voltage/pollution degree		4 KV / 3	6 KV / 3
Insulation stripping length (mm)		9	9
tightening torque value (test / max) (Nm)		0.5 / 1.2	0.5 / 1.2
Width (mm)		80	78
Length (mm)		6	6
Height mounted on TH35/7,5 (mm)		62	62
Height mounted on TH35/15 (mm)		70	70
Height mounted on G32 (mm)		66	66
Insulation material temperature index (EN 60216-1) (°C)		130	130
Plastic material		Polyamide UL94V-0	Polyamide UL94V-0

APPROVALS

ACCESSORIES			
End section	Grey	DAS/PT/GR (cod. DS101GR)	DSS/PT/GR (cod. DS301GR)
	Beige	DAS/PT (cod. DS101)	DSS/PT (cod. DS301)
	Blue	-	-
	Thickness (mm)	1.5	1.5
Cross connection	PTC or other versions (1)	PM/.../... (cod. PM...)	PTC/4/... (cod. PTC04...)
	PTP version (1)	-	PTP/4/... (cod. PTP04...)
	Rated current / Rated current ATEX applications (A)	32 / -	32 / -
Cross connection identification strip	green	-	PTC/SP (cod. PTC0990)
Switchable cross connection		POS/43 (cod. POS43)	-
Multiple common bar	250 mm	PMP/58 (cod. PMP58)	-
Shunting screw and sleeve	standard / Ex e version	CPM/01 (cod. CPM01) - CPX/01 (cod. CPX01)	-
	internal jumper	-	-
	internal jumper + external jumper	-	-
Coloured partition	red	DFU/7/R (cod. DU07R)	DFU/7/R (cod. DU07R)
Cross connection barred (upper level)	red	-	DFM/500 (cod. DF500)
Cross connection barred (lower level)	red	-	-
Cross connection barrier	red	-	-
Test plug socket		PSD/A (cod. PD001)	-
Test plug		SDD/1 (cod. DD001)	-
Modular test plug		-	-
Numbering strip		CNU/8/61 (cod. NU0861S)	CNU/8/61 (cod. NU0861S)
Single marking tag		CNU/8/61 (cod. NU0861S)	CNU/8/51 (cod. NU0851S)
		CNU/8/51 (cod. NU0851S)	CNU/8/51 (cod. NU0851S)
Warning plate	on adjacent terminal blocks	-	-
Cover for cross-connection		PRP/5 (cod. PRP05)	-
End bracket	Snap-fit TH35 and G32	BTU (cod. BT005)	BTU (cod. BT005)
	Snap-fit TH35	BTO (cod. BT007)	BTO (cod. BT007)
	Screw TH35	BT/3 (cod. BT003)	BT/3 (cod. BT003)
	Screw G32	BT/DIN/PO (cod. BT001)	BT/DIN/PO (cod. BT001)

(1) See chapter accessories for more details

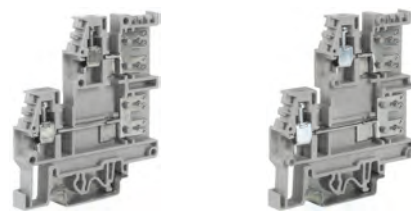

GREY VERSION	CODE	FV100GR	FF100GR
	TYPE	FVS.4/GR	FFS.4/GR
BEIGE VERSION	CODE	FV100	FF100
	TYPE	FVS.4	FFS.4
BLUE VERSION	CODE		
	TYPE		



TECHNICAL CHARACTERISTICS

Function/type		2 levels with special connections	2 levels with special connections
Rated cross-section	(mm ²)	4	4
Connecting capacity	Flexible (mm ²)	0.2 - 6	0.2 - 6
	Rigid (mm ²)	0.2 - 6	0.2 - 6
	Max. flexible with ferrule - ferrule type (mm ²)	4 - WP40/16	4 - WP40/16
Electrical characteristics According to European standard IEC EN 60947-7-1	Max AC/DC Voltage (V)	320	320
	Max current with rated cross-section (A)	20	20
	Section Caliber	A4	A4
Electrical characteristics According to UL	Max AC/DC Voltage (V)	600	600
	Max current with rated cross-section (A)	20	20
	Section Min-Max (AWG)	20 - 10	20 - 10
	Tightening torque (lb.in)	8.9	8.9
Electrical characteristics According to ATEX directive and IEC ex standard	Max AC/DC Voltage (V)	-	-
	Max current with rated cross-section (A)	-	-
	Operating temperature (°C)	-	-
Rated impulse withstand voltage/pollution degree		6 KV / 3	6 KV / 3
Insulation stripping length	(mm)	12	12
tightening torque value (test / max)	(Nm)	0.8 / 1.2	0.8 / 1.2
Width	(mm)	64	64
Length	(mm)	6.5	6.5
Height mounted on TH35/7,5	(mm)	69	69
Height mounted on TH35/15	(mm)	77	77
Height mounted on G32	(mm)	73	73
Insulation material temperature index (EN 60216-1)	(°C)	130	130
Plastic material		Polyamide UL94V-0	Polyamide UL94V-0

FVS/VCI - Cat. No. FV107
Shunting screws and sleeves for internal connection between the front and rear conducting bodies of terminal block type FVS.4



FVS/VCE - Code FV108
Screw and sleeve which, besides the internal connection, creates the internal connection, using the PMP common bar, parallel between contiguous terminal blocks

APPROVALS

ACCESSORIES

End section	Grey	FVS/PT/GR (cod. FV101GR)	FVS/PT/GR (cod. FV101GR)
	Beige	FVS/PT (cod. FV101)	FVS/PT (cod. FV101)
	Blue	-	-
	Thickness (mm)	1.5	1.5
Cross connection	PTC or other versions [1]	POF/02 (cod. POF02)	POF/02 (cod. POF02)
	PTP version [1]	-	-
	Rated current / Rated current ATEX applications (A)	32 / -	32 / -
Cross connection identification strip	green	-	-
Switchable cross connection		POS/72 (cod. POS72)	POS/72 (cod. POS72)
Multiple common bar	250 mm	PMP/02 (cod. PMP02)	PMP/02 (cod. PMP02)
Shunting screw and sleeve	standard / Ex e version	CPM/01 (cod. CPM01) - CPX/01 (cod. CPX01)	CPM/01 (cod. CPM01) - CPX/01 (cod. CPX01)
	internal jumper	FVS/VCI (cod. FV107)	-
	internal jumper + external jumper	FVS/VCE (cod. FV108)	-
Coloured partition	red	DFU/6/R (cod. DU06R)	-
Cross connection barred (upper level)	red	-	-
Cross connection barred (lower level)	red	-	-
Cross connection barrier	red	-	-
Test plug socket		PSD/A (cod. PD001)	PSD/A (cod. PD001)
Test plug		SDD/1 (cod. DD001)	SDD/1 (cod. DD001)
Modular test plug		-	-
Numbering strip		CNU/8/61 (cod. NU0861S)	CNU/8/61 (cod. NU0861S)
Single marking tag		CNU/8/51 (cod. NU0851S)	CNU/8/51 (cod. NU0851S)
		CNU/8/51 (cod. NU0851S)	CNU/8/51 (cod. NU0851S)
		-	-
Warning plate	on adjacent terminal blocks	-	-
Cover for cross-connection		PRP/6 (cod. PRP06)	PRP/6 (cod. PRP06)
End bracket	Snap-fit TH35 and G32	BTU (cod. BT005)	BTU (cod. BT005)
	Snap-fit TH35	BTO (cod. BT007)	BTO (cod. BT007)
	Screw TH35	BT/3 (cod. BT003)	BT/3 (cod. BT003)
	Screw G32	BT/DIN/PO (cod. BT001)	BT/DIN/PO (cod. BT001)

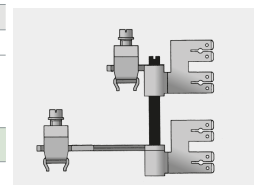

VCI
internal cross connection

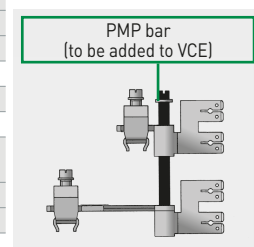

VCE
internal + front adjoining cross-connection

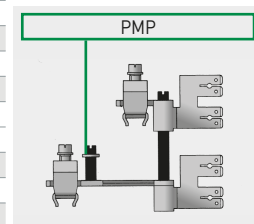

VCI + PM
internal parallel + rear adjoining cross connection

• with LOCK system



(1) See chapter accessories for more details

(2) A special version with green LED is available. TLS.2/T (cod. TL120) with green LED between upper and intermediate levels. TLS.2/U (cod. TL110) with green LED between upper and lower levels.

GREY VERSION	CODE	TL100GR
	TYPE	TLS.2/GR
BEIGE VERSION	CODE	TL100
	TYPE	TLS.2
BLUE VERSION	CODE	
	TYPE	

TECHNICAL CHARACTERISTICS

Function/type		three level - for sensors
Rated cross-section	(mm ²)	2.5
Connecting capacity	Flexible (mm ²)	0.2 - 4
	Rigid (mm ²)	0.2 - 4
	Max. flexible with ferrule - ferrule type (mm ²)	2.5 - WP25/14
Electrical characteristics According to European standard IEC EN 60947-7-1	Max AC/DC Voltage (V)	250
	Max current with rated cross-section (A)	24
	Section Caliber	A3
Electrical characteristics According to UL	Max AC/DC Voltage (V)	600
	Max current with rated cross-section (A)	15
	Section Min-Max (AWG)	20-12
	Tightening torque (lb.in)	3.5
Electrical characteristics According to ATEX directive and IEC ex standard	Max AC/DC Voltage (V)	-
	Max current with rated cross-section (A)	-
	Operating temperature (°C)	-
Rated impulse withstand voltage/pollution degree		4 KV / 3
Insulation stripping length (mm)		8
tightening torque value (test / max) (Nm)		0.4 / 0.8
Width (mm)		62.5
Length (mm)		6.2
Height mounted on TH35/7,5 (mm)		52
Height mounted on TH35/15 (mm)		60
Height mounted on G32 (mm)		-
Insulation material temperature index (EN 60216-1) (°C)		130
Plastic material		Polyamide UL94V-0



APPROVALS

ACCESSORIES		
End section	Grey	TLS/PT/GR (cod. TL101GR)
	Beige	TLS/PT (cod. TL101)
	Blue	-
Cross connection	Thickness (mm)	1.5
	PTC or other versions [1]	PM/.../... (cod. PM...)
	PTP version [1]	-
Cross connection identification strip	Rated current / Rated current ATEX applications (A)	24 / -
	green	-
Switchable cross connection		POS/41 (cod. POS41)
Multiple common bar	250 mm	PMP/02 (cod. PMP02)
Shunting screw and sleeve	standard / Ex e version	-
	internal jumper	-
	internal jumper + external jumper	-
Coloured partition	red	DFU/3/R (cod. DU03R)
Cross connection barred (upper level)	red	-
Cross connection barred (lower level)	red	-
Cross connection barrier	red	DFM/400 (cod. DF400)
Test plug socket		PSD/A (cod. PD001)
Test plug		SDD/1 (cod. DD001)
Modular test plug		-
Numbering strip		CNU/8/51 (cod. NU0851)
Single marking tag		CNU/8/51 (cod. NU0851)
		CNU/8/51 (cod. NU0851)
Warning plate	on adjacent terminal blocks	-
Cover for cross-connection		PRP/5 (cod. PRP05)
		BTU (cod. BT005)
End bracket	Snap-fit TH35 and G32	BTU (cod. BT005)
	Snap-fit TH35	BTO (cod. BT007)
	Screw TH35	BT/3 (cod. BT003)
	Screw G32	-

For the installation on limited longitudinal space where high density wiring is needed together with reliable insulation, special feed-through two/three level terminal blocks are available. The three level terminal blocks are suitable for circuits which are to be used and connected with specific equipment, as for example proximity sensors. In fact, through the combined use of TLS.2 and TLD.2 terminal blocks it is possible to connect in an optimal and economic manner both power supply conductors on input to the sensor, and those on output carrying the signal of the same. Particularly in the TLS.2 terminal block, the intermediate and lower levels can be used to feed the sensors in d.c.; the feeding is distributed on the adjoining elements of the terminal board by means of a special LOCK connection system.

The above mentioned conducting bodies have a fork, pointed towards the exterior of the terminal block, which connects to the homologous element of the adjoining terminal block. The resulting contact is clamped with a screw, supplied already inserted in the conductor element.

The LOCK system, above described, allows the connection of positive and negative poles, without the use of any other parallel cross connection. At the upper, feed-through level, the conductor for the return signal of the sensor is connected; inserting PRP/5 coloured protections in the special channels guarantees against all possible contact of the live parts and enables immediate identification of the polarity (Red for +, Blue for -).

TLD.2 terminal block is perfectly compatible with the TLS.2 for the connection of proximity sensors, as it has the same electrical and mechanical characteristics. Two of six tightening units can be connected to the sensor feeding cables and distribute the power supply to the other sensors.

The cross-connection between the intermediate and lower levels of these terminal blocks to the contiguous ones of the TLS.2 can be performed by means of the two screws provided in the fork type conducting bodies of the TLS.2 - the first of the Series - free from whatever connection; between the TLD.2 and TLS.2 terminal blocks a TLD/PI intermediate end section must be interposed, to ensure electric insulation of the TLD.2 terminal block conducting parts, which otherwise would be uncovered.

TLD.2 terminal block can also be used for other connecting applications, in other types of circuits.



(1) See chapter accessories for more details

GREY VERSION	CODE	TL200GR	TL400GR	TL500GR
	TYPE	TLD.2/GR	TLE.2/GR	TDE.2/GR
BEIGE VERSION	CODE	TL200	TL400	TL500
	TYPE	TLD.2	TLE.2	TDE.2
BLUE VERSION	CODE	TL300		
	TYPE	TLD.2 (EXI)		

TECHNICAL CHARACTERISTICS

Function/type		3 levels	2 levels + earth	2 levels feed through + earth
Rated cross-section	(mm ²)	2.5	2.5	2.5
Connecting capacity	Flexible (mm ²)	0.2 - 4	0.2 - 4	0.2 - 4
	Rigid (mm ²)	0.2 - 4	0.2 - 4	0.2 - 4
	Max. flexible with ferrule - ferrule type (mm ²)	2.5 - WP25/14	2.5 - WP25/14	2.5 - WP25/14
Electrical characteristics According to European standard IEC EN 60947-7-1	Max AC/DC Voltage (V)	250	250	250
	Max current with rated cross-section (A)	24	24	24
	Section Caliber	A3	A3	A3
Electrical characteristics According to UL	Max AC/DC Voltage (V)	600	600	600
	Max current with rated cross-section (A)	15	20	20
	Section Min-Max (AWG)	20-12	20-12	20-12
	Tightening torque (lb.in)	3.5	3.5	3.5
Electrical characteristics According to ATEX directive and IEC ex standard	Max AC/DC Voltage (V)	-	-	-
	Max current with rated cross-section (A)	-	-	-
	Operating temperature (°C)	-	-	-
Rated impulse withstand voltage/pollution degree		4 KV / 3	4 KV / 3	4 KV / 3
Insulation stripping length (mm)		8	8	8
tightening torque value (test / max) (Nm)		0.4 / 0.8	0.4 / 0.8	0.4 / 0.8
Width (mm)		85	62.5	85
Length (mm)		6.2	6.2	6.2
Height mounted on TH35/7,5 (mm)		52	52	52
Height mounted on TH35/15 (mm)		60	60	60
Height mounted on G32 (mm)		-	-	-
Insulation material temperature index (EN 60216-1) (°C)		130	130	130
Plastic material		Polyamide UL94V-0	Polyamide UL94V-0	Polyamide UL94V-0

APPROVALS

ACCESSORIES				
End section	Grey	TLD/PT/GR (cod. TL201GR)	TLS/PT/GR (cod. TL101GR)	TLS/PT/GR (cod. TL101GR)
	Beige	TLD/PT (cod. TL201)	TLS/PT (cod. TL101)	TLS/PT (cod. TL101)
	Blue	-	-	-
	Thickness (mm)	1.5	1.5	1.5
Cross connection	PTC or other versions (1)	PM/.../... (cod. PM...)	PM/.../... (cod. PM...)	PM/.../... (cod. PM...)
	PTP version (1)	-	-	-
	Rated current / Rated current ATEX applications (A)	24 / -	24 / -	24 / -
Cross connection identification strip	green	-	-	-
Switchable cross connection		POS/41 (cod. POS41)	POS/41 (cod. POS41)	POS/41 (cod. POS41)
Multiple common bar	250 mm	PMP/02 (cod. PMP02)	PMP/02 (cod. PMP02)	PMP/02 (cod. PMP02)
Shunting screw and sleeve	standard / Ex e version	-	-	-
	internal jumper	-	-	-
	internal jumper + external jumper	-	-	-
Coloured partition	red	DFU/3/R (cod. DU03R)	DFU/3/R (cod. DU03R)	DFU/3/R (cod. DU03R)
Cross connection barred (upper level)	red	-	-	-
Cross connection barred (lower level)	red	-	-	-
Cross connection barrier	red	DFM/400 (cod. DF400)	DFM/400 (cod. DF400)	DFM/400 (cod. DF400)
Test plug socket		PSD/A (cod. PD001)	PSD/A (cod. PD001)	PSD/A (cod. PD001)
Test plug		SDD/1 (cod. DD001)	SDD/1 (cod. DD001)	SDD/1 (cod. DD001)
Modular test plug		-	-	-
Numbering strip		CNU/8/51 (cod. NU0851)	CNU/8/51 (cod. NU0851)	CNU/8/51 (cod. NU0851)
Single marking tag		CNU/8/51 (cod. NU0851)	CNU/8/51 (cod. NU0851)	CNU/8/51 (cod. NU0851)
		CNU/8/51 (cod. NU0851)	CNU/8/51 (cod. NU0851)	CNU/8/51 (cod. NU0851)
Warning plate	on adjacent terminal blocks	-	-	-
Cover for cross-connection		PRP/5 (cod. PRP05)	PRP/5 (cod. PRP05)	PRP/5 (cod. PRP05)
End bracket	Snap-fit TH35 and G32	BTU (cod. BT005)	BTU (cod. BT005)	BTU (cod. BT005)
	Snap-fit TH35	BTO (cod. BT007)	BTO (cod. BT007)	BTO (cod. BT007)
	Screw TH35	BT/3 (cod. BT003)	BT/3 (cod. BT003)	BT/3 (cod. BT003)
	Screw G32	-	-	-

SCREW CLAMP

- for Ø 5 x 20 mm fuses, with possibility of warning of any broken fuse through LED microcircuit (CIL/...)

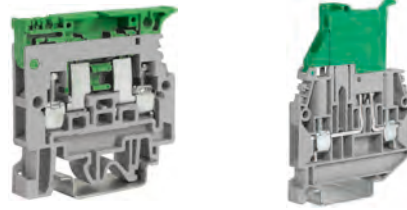

(1) See chapter accessories for more details

GREY VERSION	CODE	SF900GR	CBF04GR	Type	SFR.6	SFR.4
	TYPE	SFR.4/GR	CBF.4/GR	Voltage (V)	250	250
BEIGE VERSION	CODE	SF900		Current (A)	10	6.3
	TYPE	SFR.4		PROTECTION AGAINST OVERLOAD AND SHORT CIRCUIT		
BLUE VERSION	CODE	SF850	CBF04I	Single configuration (pv) - (w)	2.5 (2.5)	2.5
	TYPE	SFR.4 (EXII)	CBF.4 (EXII)	Composite configuration (pv) - (w)	1.6 (1)	1.6
TECHNICAL CHARACTERISTICS						
Function/type		Fuse-holders ø 5x20	Fuse-holders ø 5x20	ONLY PROTECTION AGAINST SHORT CIRCUIT		
Rated cross-section	(mm ²)	4	4	Single configuration (pvk) - (w)	4 (10)	2.5
Connecting capacity	Flexible (mm ²)	0.2 - 6	0.2 - 6	Composite configuration (pvk) - (w)	2.5 (2.5)	2.5
	Rigid (mm ²)	0.2 - 6	0.2 - 6			
	Max. flexible with ferrule - ferrule type (mm ²)	4 - WP40/16	4 - WP40/16			
Electrical characteristics According to European standard IEC EN 60947-7-1	Max AC/DC Voltage (V)	800	630			
	Max current with rated cross-section (A)	6.3 A max (20 A with CO/5)	6.3			
	Section Caliber	A4	A4			
Electrical characteristics According to UL	Max AC/DC Voltage (V)	600	600			
	Max current with rated cross-section (A)	6.3	6.3			
	Section Min-Max (AWG)	20-12	20-12			
Tightening torque (lb.in)	4.4	4.4				
Rated impulse withstand voltage/pollution degree		6 KV / 3	6 KV / 3			
Insulation stripping length (mm)		11	10			
tightening torque value (test / max) (Nm)		0.5 / 1.2	0.5 / 1			
Width (mm)		52	57			
Length (mm)		8	6			
Height mounted on TH35/7,5 (mm)		52	76			
Height mounted on TH35/15 (mm)		60	83			
Height mounted on G32 (mm)		56	-			
Insulation material temperature index (EN 60216-1) (°C)		130	130			
Plastic material		Polyamide UL94V-0	Polyamide UL94V-0			
APPROVALS						
ACCESSORIES						
End section	Grey	SFR.4/PT/GR (cod. SF701GR)	CB/PT/GR (cod. CB401GR)			
	Beige	SFR.4/PT (cod. SF701)	-			
	Blue	SFR.4/PT (Ex)I (cod. SF801)	CB/PT (Ex)I (cod. CB402)			
	Thickness (mm)	1.5	1.5			
Cross connection	PTC or other versions (1)	-	PTC/4/... (cod. PTC04...)			
	PTP version (1)	-	PTP/4/... (cod. PTP04...)			
	Rated current / Rated current ATEX applications (A)	-	32			
Cross connection identification strip	green	-	PTC/SP (cod. PTC0990)			
Coloured partition	red	DFU/3/R (cod. DU03R)	-			
Cross connection barrier		-	-			
Miniature fuse	Ø 5 x 20 mm	F5 (cod. FN...)	F5 (cod. FN...)			
	for voltage 12V 24V 48V AC/DC	CIL/12-24-48 (cod. SF518)	CIL/12-24-48 (cod. SF518)			
	for voltage 115V 230V AC/DC	CIL/115-230 (cod. SF510)	CIL/115-230 (cod. SF510)			
	for voltage 12V 24V AC/DC	-	-			
LED circuit non-polarized	for voltage 70V 380V AC/DC	-	-			
		-	-			
Terminal block with LED 12 ÷ 48 V non polarised micro-circuit		-	-			
Terminal block with LED 115 ÷ 230 V non polarised micro-circuit		-	-			
1 A diode cartridge / insert		-	-			
3 A diode cartridge / insert		-	-			
Terminal block with 1 A diode		-	-			
Terminal block with 3 A diode		-	-			
Single marking tag		CNU/08/51 (cod. CNU0851S)	CNU/08/51 (cod. CNU0851S)			
		CNU/10/61 (cod. CNU1061S)	CNU/10/61 (cod. CNU1061S)			
	Snap-fit TH35 and G32	BTU (cod. BT005)	BTU (cod. BT005)			
End bracket	Snap-fit TH35	BTO (cod. BT007)	BTO (cod. BT007)			
	Screw TH35	BT/3 (cod. BT003)	BT/3 (cod. BT003)			
	Screw G32	BT/DIN/PO (cod. BT001)	BT/DIN/PO (cod. BT001)			

- for Ø 5 x 20 mm fuses, with possibility of warning of any broken fuse through LED microcircuit (CIL/...)
- for Ø 6.3 x 32 mm fuses



[1] See chapter accessories for more details

GREY VERSION		CODE	SR500GR	SR300GR	Type	SFR.6/M	SFR.4
BEIGE VERSION		CODE	SR500	SR300	Voltage (V)	250	250
BLUE VERSION		CODE	SR600	SR400	Current (A)	6.3 / 10 max.	6.3
		TYPE	SFR.6/M [GR]	SFR.6/GR	PROTECTION AGAINST OVERLOAD AND SHORT CIRCUIT		
		TYPE	SFR.6/M	SFR.6	Single configuration (pv) - (w)	2.5 (6.3)	2.5
		TYPE	SFR.6/M [EX]I	SFR.6 [EX]I	Composite configuration (pv) - (w)	1.6 (6.3)	1.6
TECHNICAL CHARACTERISTICS							
Function/type			Fuse-holders ø 5x20	Fuse-holders ø 6x32	ONLY PROTECTION AGAINST SHORT CIRCUIT		
Rated cross-section		(mm ²)	6	6	Single configuration (pvk) - (w)	4 (10)	2.5
Connecting capacity	Flexible	(mm ²)	0.2 - 10	0.2 - 10	Composite configuration (pvk) - (w)	2.5 (6.3)	2.5
	Rigid	(mm ²)	0.2 - 10	0.2 - 10			
	Max. flexible with ferrule - ferrule type	(mm ²)	6 - WP60/20	6 - WP60/20			
Electrical characteristics According to European standard IEC EN 60947-7-1	Max AC/DC Voltage	(V)	630	630			
	Max current with rated cross-section	(A)	10 A max. (19 A with CO/5)	10 A (33 A with cylinder)			
	Section	Caliber	A5	A5			
Electrical characteristics According to UL	Max AC/DC Voltage	(V)	600	600			
	Max current with rated cross-section	(A)	6.3	10			
	Section Min-Max	[AWG]	20-8	20-8			
Tightening torque	(lb.in)	13	13				
Rated impulse withstand voltage/pollution degree			6 KV / 3	6 KV / 3			
Insulation stripping length		(mm)	11	11			
tightening torque value (test / max)		(Nm)	0.8 / 1.4	0.8 / 1.4			
Width		(mm)	79	79			
Length		(mm)	10	10			
Height mounted on TH35/7,5		(mm)	59	59			
Height mounted on TH35/15		(mm)	67	67			
Height mounted on G32		(mm)	63	63			
Insulation material temperature index (EN 60216-1)		(°C)	130	130			
Plastic material			Polyamide UL94V-0	Polyamide UL94V-0			
APPROVALS							
ACCESSORIES							
End section	Grey		SFR.6/PT/GR (cod. SR301GR)	SFR.6/PT/GR (cod. SR301GR)			
	Beige		SFR.6/PT (cod. SR301)	SFR.6/PT (cod. SR301)			
	Blue		SFR.6/PT [Ex]I (cod. SR401)	SFR.6/PT [Ex]I (cod. SR401)			
	Thickness	(mm)	1.5	1.5			
Cross connection	PTC or other versions [1]		PTC/20/... (cod. PTC20...)	PTC/20/... (cod. PTC20...)			
	PTP version [1]		-	-			
Rated current / Rated current ATEX applications (A)			25	25			
Cross connection identification strip		green	PTC/SP (cod. PTC0990)	PTC/SP (cod. PTC0990)			
Coloured partition		red	DFU/7/R (cod. DU07R)	DFU/7/R (cod. DU07R)			
Cross connection barrier			DFM/300 (cod. DF300)	DFM/300 (cod. DF300)			
Miniature fuse		Ø 5 x 20 mm	F5 (cod. FN...)	-			
LED circuit non-polarized	for voltage 12V 24V 48V AC/DC		-	-			
	for voltage 115V 230V AC/DC		-	-			
	for voltage 12V 24V AC/DC		KITLSN/12-24 (cod. KIT1224)	KITLSN/12-24 (cod. KIT1224)			
for voltage 70V 380V AC/DC		KITLSN/70-380 (cod. KIT70380)	KITLSN/70-380 (cod. KIT70380)				
Terminal block with LED 12 ÷ 48 V non polarised micro-circuit			-	-			
Terminal block with LED 115 ÷ 230 V non polarised micro-circuit			-	-			
1 A diode cartridge / insert			-	-			
3 A diode cartridge / insert			-	-			
Terminal block with 1 A diode			-	-			
Terminal block with 3 A diode			-	-			
Single marking tag			CNU/08/51 (cod. CNU0851S)	CNU/08/51 (cod. CNU0851S)			
			CNU/10/61 (cod. CNU1061S)	CNU/10/61 (cod. CNU1061S)			
End bracket	Snap-fit TH35 and G32		BTU (cod. BT005)	BTU (cod. BT005)			
	Snap-fit TH35		BTO (cod. BT007)	BTO (cod. BT007)			
	Screw TH35		BT/3 (cod. BT003)	BT/3 (cod. BT003)			
	Screw G32		BT/DIN/PO (cod. BT001)	BT/DIN/PO (cod. BT001)			

SCREW CLAMP

- for \varnothing 5 x 20 mm fuses, with possibility of warning of any broken fuse through LED microcircuit (CIL/...)
- for \varnothing 6.3 x 32 mm fuses



[1] See chapter accessories for more details

GREY VERSION		CODE	SF910GR	Type	SFR.6	SFR.4
		TYPE	SFR.4/VS/6R			
BEIGE VERSION		CODE	SF910			
		TYPE	SFR.4/VS			
BLUE VERSION		CODE	-			
		TYPE	-			

TECHNICAL CHARACTERISTICS			
Function/type		Fuse-holders \varnothing 5x20 with solder lug	
Rated cross-section		(mm ²)	4
Connecting capacity	Flexible	(mm ²)	0.2 - 6
	Rigid	(mm ²)	0.2 - 6
	Max. flexible with ferrule - ferrule type	(mm ²)	4 - WP40/16
Electrical characteristics According to European standard IEC EN 60947-7-1	Max AC/DC Voltage	(V)	400
	Max current with rated cross-section	(A)	6.3 A max (15 A with C0/5)
	Section	Caliber	A4
Electrical characteristics According to UL	Max AC/DC Voltage	(V)	-
	Max current with rated cross-section	(A)	-
	Section Min-Max	(AWG)	-
Tightening torque		(lb.in)	-
Rated impulse withstand voltage/pollution degree		4 KV / 3	
Insulation stripping length		(mm)	11
tightening torque value (test / max)		(Nm)	0.5 / 1.2
Width		(mm)	65
Length		(mm)	8
Height mounted on TH35/7,5		(mm)	52
Height mounted on TH35/15		(mm)	60
Height mounted on G32		(mm)	56
Insulation material temperature index (EN 60216-1)		(°C)	130
Plastic material		Polyamide UL94V-0	

PROTECTION AGAINST OVERLOAD AND SHORT CIRCUIT	
Single configuration (pv) - (w)	2.5 (2.5)
Composite configuration (pv) - (w)	1.6 (1) 1.6

ONLY PROTECTION AGAINST SHORT CIRCUIT	
Single configuration (pvk) - (w)	4 (10) 2.5
Composite configuration (pvk) - (w)	2.5 (2.5) 2.5

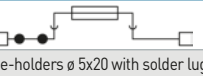

APPROVALS



ACCESSORIES		
End section	Grey	SFR.4/PT/GR (cod. SF701GR)
	Beige	SFR.4/PT (cod. SF701)
	Blue	-
	Thickness	(mm) 1.5
Cross connection	PTC or other versions [1]	-
	PTP version [1]	-
	Rated current / Rated current ATEX applications (A)	-
Cross connection identification strip	green	-
Coloured partition	red	DFU/3/R (cod. DU03R)
Cross connection barrier		-
Miniature fuse	\varnothing 5 x 20 mm	F5 (cod. FN...)
	for voltage 12V 24V 48V AC/DC	CIL/12-24-48 (cod. SF518)
	for voltage 115V 230V AC/DC	CIL/115-230 (cod. SF510)
LED circuit non-polarized	for voltage 12V 24V AC/DC	-
	for voltage 70V 380V AC/DC	-
		-
Terminal block with LED 12 ÷ 48 V non polarised micro-circuit		-
Terminal block with LED 115 ÷ 230 V non polarised micro-circuit		-
1 A diode cartridge / insert		-
3 A diode cartridge / insert		-
Terminal block with 1 A diode		-
Terminal block with 3 A diode		-
Single marking tag		CNU/08/51 (cod. CNU0851S)
		CNU/10/61 (cod. CNU1061S)
End bracket	Snap-fit TH35 and G32	BTU (cod. BT005)
	Snap-fit TH35	BTO (cod. BT007)
	Screw TH35	BT/3 (cod. BT003)
	Screw G32	BT/DIN/PO (cod. BT001)

- for Ø 5 x 20 mm fuses, with possibility of warning of any broken fuse through LED microcircuit (CIL/...)
- for 1 A diodes (types 1N4001 – 1N4007)



(1) See chapter accessories for more details
Components are not included

GREY VERSION	CODE	DA200GR
	TYPE	DSF.4/GR
BEIGE VERSION	CODE	DA200
	TYPE	DSF.4
BLUE VERSION	CODE	
	TYPE	

TECHNICAL CHARACTERISTICS

Function/type	Two levels fuse-holders ø 5x20 + feed through	
Rated cross-section	(mm ²)	4
Connecting capacity	Flexible	(mm ²) 0,2 ÷ 6
	Rigid	(mm ²) 0,2 ÷ 6
	Max. flexible with ferrule - ferrule type	(mm ²) 4 - WP40/16
Electrical characteristics According to European standard IEC EN 60947-7-1	Max AC/DC Voltage	(V) 800
	Max current with rated cross-section	(A) 6.3 A (10 A with CO/5) (upper level) 32 A (lower level)
Electrical characteristics According to UL	Section	Caliber A4
	Max AC/DC Voltage	(V) -
	Max current with rated cross-section	(A) -
	Section Min-Max	(AWG) -
	Tightening torque	(lb.in) -
Rated impulse withstand voltage/pollution degree		8 kV / 3
Insulation stripping length	(mm)	9
tightening torque value (test / max)	(Nm)	0,5 / 1,2
Width	(mm)	79.5
Length	(mm)	8
Height mounted on TH35/7,5	(mm)	69
Height mounted on TH35/15	(mm)	77
Height mounted on G32	(mm)	-
Insulation material temperature index (EN 60216-1)	(°C)	130
Plastic material		Polyamide UL94V-0



APPROVALS



ACCESSORIES		
End section	Grey	DSF.4/PT/GR (cod. DS401GR)
	Beige	DSF.4/PT D(cod. DS401)
	Blue	-
Cross connection	Thickness (mm)	1.5
	PTC or other versions (1)	-
	PTP version (1)	-
Cross connection identification strip	Rated current / Rated current ATEX applications (A)	-
	green	-
Coloured partition	red	DFU/7/R (cod. DU07R)
Cross connection barrier		-
Miniature fuse	Ø 5 x 20 mm	F5 (cod. FN...)
	for voltage 12V 24V 48V AC/DC	CIL/12-24-48 (cod. SF518)
LED circuit non-polarized	for voltage 115V 230V AC/DC	CIL/115-230 (cod. SF510)
	for voltage 12V 24V AC/DC	-
	for voltage 70V 380V AC/DC	-
Terminal block with LED 12 ÷ 48 V non polarised micro-circuit		DSF.4/GR/C12-48 (cod. DA518GR)
Terminal block with LED 115 ÷ 230 V non polarised micro-circuit		DSF.4/GR/C115-230 (cod. DA510GR)
1 A diode cartridge / insert		SFR/11A (cod. SF992)
3 A diode cartridge / insert		SFR/13A (cod. SF993)
Terminal block with 1 A diode		DSF.4/GR/D1A (cod. DA901GR)
Terminal block with 3 A diode		DSF.4/GR/D3A (cod. DA903GR)
Single marking tag		CNU/08/51 (cod. CNU0851S)
		CNU/10/61 (cod. CNU1061S)
End bracket	Snap-fit TH35 and G32	BTU (cod. BT005)
	Snap-fit TH35	BTO (cod. BT007)
	Screw TH35	BT/3 (cod. BT003)
	Screw G32	-

- for “blade” fuse in compliance with DIN 72581/3F – ISO 8820
- combinable with CPF05 components holder (see accessories chapter for more details)

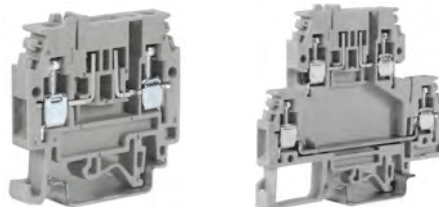

(1) See chapter accessories for more details
 (2) 10A max. with conducting element VL103 combined with CPF05. 6.3A max with fuse combined with CPF05
 (3) Approvals referred to use with CPF/5 component holder cartridge

GREY VERSION	CODE	MF100GR	DA100GR
BEIGE VERSION	CODE	MF100	DA100
	TYPE	MPFA.4/GR	DSFA.4/GR
	TYPE	MPFA.4	DSFA.4

TECHNICAL CHARACTERISTICS

Function/type		Blade fuse holder	2 levels, blade fuse holder + feed through
Rated cross-section	(mm ²)	4	4
Connecting capacity	Flexible	0,2 ÷ 6	0,2 ÷ 6
	Rigid	0,2 ÷ 6	0,2 ÷ 6
	Max. flexible with ferrule - ferrule type	4 - WP40/16	4 - WP40/16
Electrical characteristics According to European standard IEC EN 60947-7-1	Max AC/DC Voltage	400	400
	Max current with rated cross-section	10 [2]	10 [2] / 32
	Section	A4	A4
Electrical characteristics According to UL	Max AC/DC Voltage	600	300
	Max current with rated cross-section	6.3	6.3-30
	Section Min - Max	26-10	26-10
	Tightening torque	4.4	4.4
Rated impulse withstand voltage/pollution degree		6 KV / 3	6 KV / 3
Insulation stripping length	(mm)	9	9
Tightening torque nominal/max	(Nm)	0,5 / 1,2	0,5 / 1,2
Width	(mm)	47	78
Length	(mm)	6	6
Height mounted on TH35/7,5	(mm)	47	68
Height mounted on TH35/15	(mm)	55	75
Height mounted on G32	(mm)	51	72
Insulation material temperature index [EN 60216-1]	(°C)	130	130
Plastic material		polyamide UL94V-0	polyamide UL94V-0

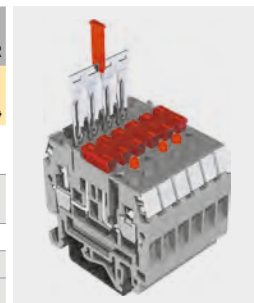

MPFA.4 – detail of the terminal blocks with numbering CNU/8 and CNU/8/51, “blade” fuse seen from the PTC/4 cross connection and seen from the PTC cross connection. The terminal block can be supplied already including a non-polarised LED warning circuit, to warn if the fuse breaks. Two versions are available, depending on the different power supply voltages.

APPROVALS



ACCESSORIES

End section	Grey	MPS.4/PT/GR [cod. MP901GR]	DSS/PT/GR [cod. DS301GR]
	Beige	MPS.4/PT [cod. MP901]	DSS/PT [cod. DS301]
	Blue	-	-
Cross connection	Thickness (mm)	1.5	1.5
	PTC version (1)	PTC/4/... [cod. PTC04...]	PTC/4/... [cod. PTC04...]
	Rated current (A)	32	32
Coloured partition	red	DFU/3/R [cod. DU03R]	DFU/7/R [cod. DU07R]
Cross connection barrier	red	DFM/500 [cod. DF500]	DFM/500 [cod. DF500]
Blade-type fuses according to DIN 72581/3F ISO 8820 - max voltage 32 V In = 2A, 5A, 7.5A, 15A (1)		F32/... [cod. FN032...]	F32/... [cod. FN032...]
Terminal block with LED 12V cricuit unpolarized		MPFA.4/L12 [cod. MF112]	DSFA.4/L12 [cod. DA112]
Terminal block with LED 24V cricuit unpolarized		MPFA.4/L24 [cod. MF124]	DSFA.4/L24 [cod. DA124]
Marking tag		CNU/08/51 [cod. CNU0851S]	CNU/08/51 [cod. CNU0851S]
		CNU/10/61 [cod. CNU1061S]	CNU/10/61 [cod. CNU1061S]
	Snap-fit TH35 and G32	BTU [cod. BT005]	BTU [cod. BT005]
	Snap-fit TH35	BTO [cod. BT007]	BTO [cod. BT007]
	Screw TH35	BT/3 [cod. BT003]	BT/3 [cod. BT003]
End bracket	Screw G32	BT/DIN/PO [cod. BT001]	BT/DIN/PO [cod. BT001]

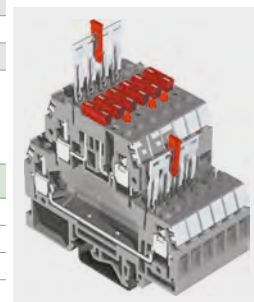

DSFA.4 – detail of the terminal blocks with numbering CNU/8 and CNU/8/51, blade fuse and view of the PTC/4 cross connections on the upper level (upstream from the fuse) and on the lower level. The terminal block can be supplied already including a non-polarised LED warning circuit, to warn if the fuse breaks. Two versions are available, depending on the different power supply voltages. **DSFA.4/L12** code DA112 (complete with non-polarised 12 V LED circuit) **DSFA.4/L24** code DA124 (complete with non-polarised 24 V LED circuit)

- for Ø 6.3 x 32 mm fuses
- for Ø 6.3 x 32 mm fuses, with possibility of warning of any broken fuse through LED microcircuit (CIL/...)
- No end section required



[1] value referred to the insulation characteristics of the terminal blocks

BEIGE VERSION		CODE TYPE	FP100	FP300	FP200
			FPC.10	FPL.10/C	FPL.10/L
TECHNICAL CHARACTERISTICS					
Function/type			fuse holder Ø 6.3 x 32 mm	fuse holder Ø 6.3 x 32 mm with LED	fuse holder Ø 6.3 x 32 mm with lamp
Rated cross-section		(mm ²)	10	10	10
Connecting capacity	Flexible	(mm ²)	1.5 - 16	1.5 - 16	1.5 - 16
	Rigid	(mm ²)	1.5 - 16	1.5 - 16	1.5 - 16
	Max. flexible with ferrule - ferrule type	(mm ²)	10 - WP100/21	10 - WP100/21	10 - WP100/21
Electrical characteristics According to European standard IEC EN 60947-7-1	Max AC/DC Voltage	(V)	800	800	800
	Max current with rated cross-section	(A)	10 A [20 A with SFC/CO]	10	10 A [20 A with SFC/CO]
	Section	Caliber	B6	B6	B6
Electrical characteristics According to UL	Max AC/DC Voltage	(V)	600	300	300
	Max current with rated cross-section	(A)	15	15	15
	Section Min - Max	(AWG)	20 - 6	20 - 6	20 - 6
	Tightening torque	(lb.in)	7	7	7
Rated impulse withstand voltage/pollution degree			6 KV (1) / 3	6 KV (1) / 3	6 KV (1) / 3
Insulation stripping length		(mm)	17	17	17
Tightening torque value (test / max)		(Nm)	1.2 / 1.9	1.2 / 1.9	1.2 / 1.9
Width		(mm)	63	63	63
Length		(mm)	12	12	12
Height mounted on TH35/7,5		(mm)	70	71	71
Height mounted on TH35/15		(mm)	78	79	79
Height mounted on G32		(mm)	74	75	75
Insulation material temperature index (EN 60216-1)		(°C)	130	130	130
Plastic material			polyamide UL94V-0	polyamide UL94V-0	polyamide UL94V-0
APPROVALS					
ACCESSORIES					
Coloured partition		red			
Test plug			DFU/6/R (cod. DU06R)	DFU/6/R (cod. DU06R)	DFU/6/R (cod. DU06R)
MSM handle		simultaneous disconnection of 6 terminal blocks	SDD/2 (cod. DD002)	-	-
Neon lamp Ø 6 x 26 mm			MSM (cod. FC103)	MSM (cod. FC103)	MSM (cod. FC103)
Non polarized LED circuit		12-24-48V AC/DC voltages	-	-	LSN (cod. FL202)
Non polarized LED circuit		115-230V AC/DC voltages	-	CIL/12-24-48 (cod. SF518)	-
Marking tag			-	CIL/115-230 (cod. SF510)	-
End bracket		Snap-fit TH35 and G32	CNU/08/51 (cod. NU0851S)	CNU/08/51 (cod. NU0851S)	CNU/08/51 (cod. NU0851S)
		Snap-fit TH35	CNU/10/61 (cod. NU1061S)	CNU/10/61 (cod. NU1061S)	CNU/10/61 (cod. NU1061S)
		Screw TH35	BTU (cod. BT005)	BTU (cod. BT005)	BTU (cod. BT005)
		Screw G32	BTO (cod. BT007)	BTO (cod. BT007)	BTO (cod. BT007)
			BT/3 (cod. BT003)	BT/3 (cod. BT003)	BT/3 (cod. BT003)
			BT/DIN/PO (cod. BT001)	BT/DIN/PO (cod. BT001)	BT/DIN/PO (cod. BT001)

- for Ø 5x20 mm fuses, with LED warning circuit capable of detecting intervention of the fuse
- with LED (CIL) microcircuits - non-polarised for operation under alternating and/or direct current



[1] See chapter accessories for more details

BEIGE VERSION WITH 12-24-48V LED CIRCUIT	CODE	SF948		FP948
	TYPE		SFR.4/C48	FPL.10/C48
BEIGE VERSION WITH 100-230V LED CIRCUIT	CODE	SF923		SF923
	TYPE		SFR.4/C230	FPL.10/C230
GREY VERSION WITH 12-24-48V LED CIRCUIT	CODE	SF948GR		
	TYPE		SFR.4/C48/GR	CBF.4/C48/GR
GREY VERSION WITH 100-230V LED CIRCUIT	CODE	SF923GR		
	TYPE		SFR.4/C230/GR	CBF.4/C23/GR

TECHNICAL CHARACTERISTICS

Function/type		For Ø 5 x 20 mm fuse and LED circuit	For Ø 5 x 20 mm fuse and LED circuit	For Ø 6.3 x 32 mm fuse and LED circuit
Rated cross-section	(mm ²)	4	4	10
Connecting capacity	Flexible (mm ²)	0.2 - 6	0.2 - 6	1.5 - 16
	Rigid (mm ²)	0.2 - 6	0.2 - 6	1.5 - 16
	Max. flexible with ferrule - ferrule type (mm ²)	4 - WP40/16	4 - WP40/16	10 - WP100/21
Electrical characteristics According to European standard IEC EN 60947-7-1	Max AC/DC Voltage (V)	800	630	800
	Max current with rated cross-section (A)	6.3	6.3 A max [20A con CO/5]	10
	Section (Caliber)	A4	A4	B6
Electrical characteristics According to UL	Max AC/DC Voltage (V)	600	600	300
	Max current with rated cross-section (A)	6.3	6.3	15
	Section Min - Max (AWG)	20-12	20 - 12	20 - 6
	Tightening torque (lb.in)	4.4	4.4	7
Rated impulse withstand voltage/pollution degree		6 KV / 3	6 KV / 3	6 KV / 3
Insulation stripping length	(mm)	11	11	17
Tightening torque value (test / max)	(Nm)	0.5 / 1.2	0.5 / 1	1.2 / 1.9
Width	(mm)	52	57	63
Length	(mm)	8	6	12
Height mounted on TH35/7,5	(mm)	52	76	71
Height mounted on TH35/15	(mm)	60	83	79
Height mounted on G32	(mm)	56	-	75
Insulation material temperature index (EN 60216-1)	(°C)	130	130	130
Plastic material		polyamide UL94V-0	polyamide UL94V-0	polyamide UL94V-0

APPROVALS



ACCESSORIES

End section	Grey	SFR/PT/GR (cod. SF701GR)	CB/PT/GR (cod. CB401GR)	-
	Beige	SFR/PT (cod. SF701)	-	-
	Thickness (mm)	1.5	1.5	-
Cross connection	PTC version [1]	-	PTC/4/... (cod. PTC04...)	-
	PTP version [1]	-	PTP/4/... (cod. PTP04...)	-
	Rated current (A)	-	32	-
Cross connection identification strip	green	-	PTC/SP (cod. PTC0990)	-
Coloured partition	red	DFU/3/R (cod. DU03R)	-	DFU/6/R (cod. DU06R)
MSM handle	simultaneous disconnection of 6 terminal blocks	-	-	MSM (cod. FC103)
Miniature fuse Ø 5 x 20 mm		F5/... (cod. FN...)	F5/... (cod. FN...)	-
Conducting element		CO/5 (cod. VL103)	CO/5 (cod. VL103)	-
Marking tag		CNU/8/51 (cod. NU0851S)	CNU/8/51 (cod. NU0851S)	-
		CNU/10/61 (cod. NU1061S)	CNU/10/61 (cod. NU1061S)	-
		BTU (cod. BT005)	BTU (cod. BT005)	BTU (cod. BT005)
End bracket	Snap-fit TH35 and G32	BTU (cod. BT005)	BTU (cod. BT005)	BTU (cod. BT005)
	Snap-fit TH35	BTO (cod. BT007)	BTO (cod. BT007)	BTO (cod. BT007)
	Screw TH35	BT/3 (cod. BT003)	BT/3 (cod. BT003)	BT/3 (cod. BT003)
	Screw G32	BT/DIN/PO (cod. BT001)	-	BT/DIN/PO (cod. BT001)

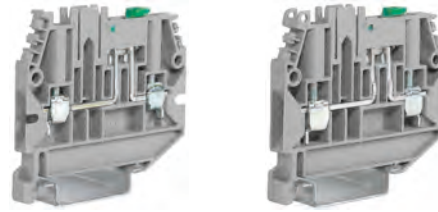

[1] See chapter accessories for more details

GREY VERSION	CODE TYPE	CBS02GR CBS.2/GR	CBS04GR CBS.4/GR
BEIGE VERSION	CODE TYPE	CBS02 CBS.2	CBS04 CBS.4
BLUE VERSION	CODE TYPE	CBS02I CBS.2 (EX) I	CBS04I CBS.4 (EX) I

TECHNICAL CHARACTERISTICS

Function/type		"blade" switchable	"blade" switchable
Rated cross-section	(mm ²)	2	4
Connecting capacity	Flexible	0,2 ÷ 4	0,2 ÷ 6
	Rigid	0,2 ÷ 4	0,2 ÷ 6
	Max. flexible with ferrule - ferrule type	2 - WP25/14	4 - WP40/16
Electrical characteristics According to European standard IEC EN 60947-7-1	Max AC/DC Voltage	630	630
	Max current with rated cross-section	20	25
	Section	Caliber A3	A4
Electrical characteristics According to UL	Max AC/DC Voltage	600	600
	Max current with rated cross-section	20	24
	Section Min - Max	20-12	20-10
	Tightening torque	3.5	4.4
Rated impulse withstand voltage/pollution degree		6 KV / 3	6 KV / 3
Insulation stripping length	(mm)	9	10
Tightening torque value (test / max)	(Nm)	0,4 / 0,6	0,5 / 0,8
Width	(mm)	57	57
Length	(mm)	5	6
Height mounted on TH35/7,5	(mm)	52	52
Height mounted on TH35/15	(mm)	60	60
Height mounted on G32	(mm)	-	-
Insulation material temperature index (EN 60216-1)	(°C)	130	130
Plastic material		polyamide UL94V-0	polyamide UL94V-0



APPROVALS



ACCESSORIES

End section	Grey	CB/PT/GR [cod. CB401GR]	CB/PT/GR [cod. CB401GR]
	Beige	CB/PT [cod. CB401]	CB/PT [cod. CB401]
	Blue	CB/PT (Ex)i [cod. CB402]	CB/PT (Ex)i [cod. CB402]
	Thickness	(mm) 1,5	1,5
Cross connection	PTC version [1]	PTC/2/... [cod. PTC02...]	PTC/4/... [cod. PTC04...]
	PTP version [1]	PTP/2/... [cod. PTP02...]	PTP/4/... [cod. PTP04...]
	Rated current	24	32
Switchable cross connection		-	-
Cross connection identification strip	green	PTC/SP [cod. PTC0990]	PTC/SP [cod. PTC0990]
Multiple common bar		-	-
Shunting screw and sleeve		-	-
Coloured partition	red	DFU/3/R [cod. DU03R]	DFU/3/R [cod. DU03R]
Cross connection barrier	red	DFM/800 [cod. DF800] - DFM/900 [cod. DF900]	DFM/800 [cod. DF800] - DFM/900 [cod. DF900]
Test plug		-	-
Short-circuit plate	2 poles	-	-
	4 poles	-	-
Brass conducting element		-	-
Screw and sleeve for short-circuit plates		-	-
MSM handle		-	-
Marking tag		CNU/8/51 [cod. NU0851S]	CNU/8/51 [cod. NU0851S]
		CNU/10/61 [cod. NU1061S]	CNU/10/61 [cod. NU1061S]
End bracket	Snap-fit TH35 and G32	BTU [cod. BT005]	BTU [cod. BT005]
	Snap-fit TH35	BTO [cod. BT007]	BTO [cod. BT007]
	Screw TH35	BT/3 [cod. BT003]	BT/3 [cod. BT003]
	Screw G32	BT/DIN/PO [cod. BT001]	BT/DIN/PO [cod. BT001]



[1] See chapter accessories for more details

GREY VERSION	CODE TYPE	MP950GR MPS.4/GR	DS400GR DSS.4/GR
BEIGE VERSION	CODE TYPE	MP950 MPS.4	DS400 DSS.4
BLUE VERSION	CODE TYPE	MP960 MPS.4/SW [EXI]	

TECHNICAL CHARACTERISTICS

Function/type		"blade" switchable	2 levels disconnect	
Rated cross-section	(mm ²)	4	4	
Connecting capacity	Flexible	0,2 ÷ 6	0,2 ÷ 6	
	Rigid	0,2 ÷ 6	0,2 ÷ 6	
	Max. flexible with ferrule - ferrule type	4 - WP40/16	4 - WP40/16	
Electrical characteristics According to European standard IEC EN 60947-7-1	Max AC/DC Voltage	400	400	
	Max current with rated cross-section	24	24(upper circuit)-32(lower circuit)	
	Section	Caliber	A4	A4
Electrical characteristics According to UL	Max AC/DC Voltage	600	300	
	Max current with rated cross-section	24	24(upper circuit)-32(lower circuit)	
	Section Min - Max	[AWG]	26-10	26-10
	Tightening torque	(lb.in)	4.4	4.4
Rated impulse withstand voltage/pollution degree		6 KV / 3	6 KV / 3	
Insulation stripping length	(mm)	9	9	
Tightening torque value (test / max)	(Nm)	0,5 / 1,2	0,5 / 1,2	
Width	(mm)	47	78	
Length	(mm)	6	6	
Height mounted on TH35/7,5	(mm)	47	68	
Height mounted on TH35/15	(mm)	55	75	
Height mounted on G32	(mm)	51	72	
Insulation material temperature index (EN 60216-1)	(°C)	130	130	
Plastic material		polyamide UL94V-0	polyamide UL94V-0	

APPROVALS



ACCESSORIES			
End section	Grey	MPS.4/PT/GR (cod. MP901GR)	DSS/PT/GR (cod. DS301GR)
	Beige	MPS.4/PT (cod. MP910)	DSS/PT (cod. DS301)
	Blue	MPS.4/PT [Ex] i (cod. MP902)	-
	Thickness	(mm)	1,5
Cross connection	PTC version [1]	PTC/4/... (cod. PTC04...)	PTC/4/... (cod. PTC04...)
	PTP version [1]	PTP/4/... (cod. PTP04...)	PTP/4/... (cod. PTP04...)
	Rated current	(A)	32
Switchable cross connection		-	-
Cross connection identification strip	green	PTC/SP (cod. PTC0990)	PTC/SP (cod. PTC0990)
Multiple common bar		-	-
Shunting screw and sleeve		-	-
Coloured partition	red	DFU/3/R (cod. DU03R)	DFU/7/R (cod. DU07R)
Cross connection barrier	red	DFM/500 (cod. DF500)	DFM/500 (cod. DF500)
Test plug		-	-
Short-circuit plate	2 poles	-	-
	4 poles	-	-
Brass conducting element		-	-
Screw and sleeve for short-circuit plates		-	-
MSM handle		-	-
Marking tag		CNU/8/51 (cod. NU0851S)	CNU/8/51 (cod. NU0851S)
		CNU/10/61 (cod. NU1061S)	CNU/10/61 (cod. NU1061S)
End bracket	Snap-fit TH35 and G32	BTU (cod. BT005)	BTU (cod. BT005)
	Snap-fit TH35	BTO (cod. BT007)	BTO (cod. BT007)
	Screw TH35	BT/3 (cod. BT003)	BT/3 (cod. BT003)
	Screw G32	BT/DIN/PO (cod. BT001)	BT/DIN/PO (cod. BT001)

- disconnects by means of conducting element to be inserted in the lever
- disconnects with special connections
- Ø 5 x 20 mm CO/5 conducting element - in tin plated brass to be inserted in the lever

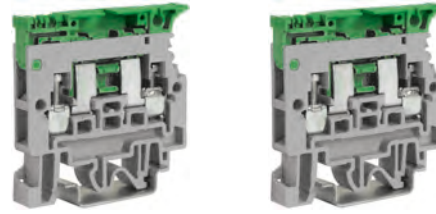

[1] See chapter accessories for more details

GREY VERSION	CODE	SF900GR	SF910GR
	TYPE	SFR.4/GR	SFR.4/VS/GR
BEIGE VERSION	CODE	SF900	SF910
	TYPE	SFR.4	SFR.4/VS
BLUE VERSION	CODE	SF850	
	TYPE	SFR.4 [EX]i	

TECHNICAL CHARACTERISTICS

Function/type	disconnect	disconnect, with solder lug
Rated cross-section	(mm ²) 4	4
Connecting capacity	Flexible (mm ²) 0,2 ÷ 6	0,2 ÷ 6
	Rigid (mm ²) 0,2 ÷ 6	0,2 ÷ 6
	Max. flexible with ferrule - ferrule type (mm ²) 4 - WP40/16	4 - WP40/16
Electrical characteristics According to European standard IEC EN 60947-7-1	Max AC/DC Voltage (V) 800	400
	Max current with rated cross-section (A) 20 A (with CO/5)	15 A (with CO/5)
Electrical characteristics According to UL	Section Caliber A3	A4
	Max AC/DC Voltage (V) 600	-
	Max current with rated cross-section (A) 6.3	-
	Section Min - Max (AWG) 20-12	-
Tightening torque (lb.in) 4.4	-	
Rated impulse withstand voltage/pollution degree	6 KV / 3	4 KV / 3
Insulation stripping length (mm) 11	11	
Tightening torque value (test / max) (Nm) 0,5 / 1,2	0,5 / 1,2	
Width (mm) 52	65	
Length (mm) 8	8	
Height mounted on TH35/7,5 (mm) 52	52	
Height mounted on TH35/15 (mm) 60	60	
Height mounted on G32 (mm) 56	56	
Insulation material temperature index (EN 60216-1) (°C) 130	130	
Plastic material	polyamide UL94V-0	polyamide UL94V-0



APPROVALS



ACCESSORIES			
End section	Grey	SFR.4/PT/GR (cod. SF701GR)	SFR.4/PT/GR (cod. SF701GR)
	Beige	SFR.4/PT (cod. SF701)	SFR.4/PT (cod. SF701)
	Blue	SFR.4/PT (Ex)i (cod. SF801)	-
	Thickness (mm) 1.5	1.5	1.5
Cross connection	PTC version [1]	-	-
	PTP version [1]	-	-
	Rated current (A)	-	-
Switchable cross connection	-	-	
Cross connection identification strip green	-	-	
Multiple common bar	-	-	
Shunting screw and sleeve	-	-	
Coloured partition red	-	-	
Cross connection barrier red	-	-	
Test plug	-	-	
Short-circuit plate	2 poles	-	-
	4 poles	-	-
Brass conducting element	CO/5 (cod. VL103)	CO/5 (cod. VL103)	
Screw and sleeve for short-circuit plates	-	-	
MSM handle	-	-	
Marking tag	CNU/8/51 (cod. NU0851S)	CNU/8/51 (cod. NU0851S)	
	CNU/10/61 (cod. NU1061S)	CNU/10/61 (cod. NU1061S)	
End bracket	Snap-fit TH35 and G32	BTU (cod. BT005)	BTU (cod. BT005)
	Snap-fit TH35	BTO (cod. BT007)	BTO (cod. BT007)
	Screw TH35	BT/3 (cod. BT003)	BT/3 (cod. BT003)
	Screw G32	BT/DIN/PO (cod. BT001)	BT/DIN/PO (cod. BT001)

SCREW CLAMP

- disconnects by means of conducting element to be inserted in the lever
- disconnects with special connections
- possibly to perform parallel connections
- Ø 6x 32 mm CO/6 conducting element - in tin plated brass to be inserted in the lever

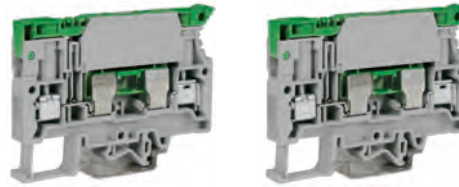

[1] See chapter accessories for more details

GREY VERSION	CODE TYPE	SR500GR	SR300GR
		SFR.6/M/GR	SFR.6/GR
BEIGE VERSION	CODE TYPE	SR500	SR300
		SFR.6/M	SFR.6
BLUE VERSION	CODE TYPE	SR600	SR400
		SFR.6/M [EX]I	SFR.6 [EX]I

TECHNICAL CHARACTERISTICS

Function/type		disconnect	disconnect
Rated cross-section	(mm ²)	6	6
Connecting capacity	Flexible	0,2 ÷ 10	0,2 ÷ 10
	Rigid	0,2 ÷ 10	0,2 ÷ 10
	Max. flexible with ferrule - ferrule type	4 - WP60/20	6 - WP60/20
Electrical characteristics According to European standard IEC EN 60947-7-1	Max AC/DC Voltage	630	630
	Max current with rated cross-section	19 A (with CO/5)	33 (with cylinder)
	Section	Caliber A5	A5
Electrical characteristics According to UL	Max AC/DC Voltage	600	600
	Max current with rated cross-section	6.3	10
	Section Min - Max	20-8	20-8
	Tightening torque	13	13
Rated impulse withstand voltage/pollution degree		6 KV / 3	6 KV / 3
Insulation stripping length	(mm)	11	11
Tightening torque value (test / max)	(Nm)	0,8 / 1,4	0,8 / 1,4
Width	(mm)	79	79
Length	(mm)	10	10
Height mounted on TH35/7,5	(mm)	59	59
Height mounted on TH35/15	(mm)	67	67
Height mounted on G32	(mm)	63	63
Insulation material temperature index (EN 60216-1)	(°C)	130	130
Plastic material		polyamide UL94V-0	polyamide UL94V-0

APPROVALS

ACCESSORIES

End section	Grey	SFR.6/PT/GR (cod. SR301GR)	SFR.6/PT/GR (cod. SR301GR)
	Beige	SFR.6/PT (cod. SR301)	SFR.6/PT (cod. SR301)
	Blue	SFR.6/PT [Ex]i (cod. SR401)	SFR.6/PT [Ex]i (cod. SR401)
	Thickness	(mm) 1.5	1.5
Cross connection	PTC version [1]	PTC/20/... (cod. PTC20...)	PTC/20/... (cod. PTC20...)
	PTP version [1]	-	-
	Rated current	(A) 25	25
Switchable cross connection		-	-
Cross connection identification strip	green	PTC/SP (cod. PTC0990)	PTC/SP (cod. PTC0990)
Multiple common bar		-	-
Shunting screw and sleeve		-	-
Coloured partition	red	DFU/7/R (cod. DU07R)	DFU/7/R (cod. DU07R)
Cross connection barrier	red	DFM/300 (cod. DF300)	DFM/300 (cod. DF300)
Test plug		SDD/1 (cod. DD001)	SDD/1 (cod. DD001)
Short-circuit plate	2 poles	-	-
	4 poles	-	-
Brass conducting element		CO/5 (cod. VL103)	CO/6 (cod. CO06)
Screw and sleeve for short-circuit plates		-	-
MSM handle		-	-
Marking tag		CNU/8/51 (cod. NU0851S)	CNU/8/51 (cod. NU0851S)
		CNU/10/61 (cod. NU1061S)	CNU/10/61 (cod. NU1061S)
End bracket	Snap-fit TH35 and G32	BTU (cod. BT005)	BTU (cod. BT005)
	Snap-fit TH35	BTO (cod. BT007)	BTO (cod. BT007)
	Screw TH35	BT/3 (cod. BT003)	BT/3 (cod. BT003)
	Screw G32	BT/DIN/PO (cod. BT001)	BT/DIN/PO (cod. BT001)



- disconnects by means of conducting element to be inserted in the lever
- slide link disconnect
- possibly to perform parallel connections
- Ø 6x 32 mm CO/6 conducting element - in tin plated brass to be inserted in the lever

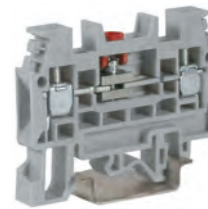

[1] See chapter accessories for more details

GREY VERSION	CODE		SB300GR
	TYPE		SCB.4/GR
BEIGE VERSION	CODE	FP100	SB300
	TYPE	FPC.10	SCB.4
BLUE VERSION	CODE		
	TYPE		

TECHNICAL CHARACTERISTICS

Function/type		disconnect	disconnect by slide link
Rated cross-section	(mm ²)	10	4
Connecting capacity	Flexible	1,5 ÷ 16	0,2 ÷ 6
	Rigid	1,5 ÷ 16	0,2 ÷ 6
	Max. flexible with ferrule - ferrule type	10 - WP100/21	4 - WP40/16
Electrical characteristics According to European standard IEC EN 60947-7-1	Max AC/DC Voltage	800	800
	Max current with rated cross-section	20 (with SFC/CO)	32
Electrical characteristics According to UL	Section	Caliber B6	A4
	Max AC/DC Voltage	600	600
Rated impulse withstand voltage/pollution degree	Max current with rated cross-section	15	20
	Section Min - Max	20-6	20-12
	Tightening torque	7	4,4
Rated impulse withstand voltage/pollution degree		6 KV / 3	8 KV / 3
Insulation stripping length	(mm)	17	9
Tightening torque value (test / max)	(Nm)	1,2 / 1,9	0,5 / 1,2
Width	(mm)	63	58
Length	(mm)	12	6,5
Height mounted on TH35/7,5	(mm)	70	44
Height mounted on TH35/15	(mm)	79	52
Height mounted on G32	(mm)	75	48
Insulation material temperature index (EN 60216-1)	(°C)	130	130
Plastic material		polyamide UL94V-0	polyamide UL94V-0



APPROVALS



ACCESSORIES

End section	Grey	-	SCB.4/PT/GR (cod. SB301GR)
	Beige	-	SCB.4/PT (cod. SB301)
	Blue	-	-
Cross connection	Thickness	(mm) 1,5	1,5
	PTC or other version [1]	-	PM/40/... (cod. PM4...)
	PTP version [1]	-	-
Switchable cross connection	Rated current	(A) -	32
		-	POS/12 (cod. POS12)
Cross connection identification strip	green	-	-
Multiple common bar		-	PMP/42 (cod. PMP42)
Shunting screw and sleeve		-	CPM/12 (cod. CPM12)
Coloured partition	red	DFU/6/R (cod. DU06R)	DFU/3/R (cod. DU03R)
Cross connection barrier	red	-	-
Test plug		SDD/2 (cod. DD002)	SDD/6-SDD/1 (cod. DD006-DD001)
Short-circuit plate	2 poles	-	SCB/4/PO/2 (cod. SB303)
	4 poles	-	SCB/4/PO/4 (cod. SB304)
Brass conducting element		SFC/CO (cod. FC102)	-
Screw and sleeve for short-circuit plates		-	SCB/4/CPM (cod. SB305)
MSM handle		MSM (cod. FC103)	-
Marking tag		CNU/8/51 (cod. NU0851S)	CNU/8/51 (cod. NU0851S)
		CNU/10/61 (cod. NU1061S)	CNU/10/61 (cod. NU1061S)
End bracket	Snap-fit TH35 and G32	BTU (cod. BT005)	BTU (cod. BT005)
	Snap-fit TH35	BTO (cod. BT007)	BTO (cod. BT007)
	Screw TH35	BT/3 (cod. BT003)	BT/3 (cod. BT003)
	Screw G32	BT/DIN/PO (cod. BT001)	BT/DIN/PO (cod. BT001)

WITH UL94V-0 POLYAMIDE INSULATING BODY

- Universal mounting for both PR/DIN and PR/3 rails which meet IEC 60715 norms, "G32" and TH/35 types

In SCB.6 type terminal block, the use of special cross-connections, formed by

SCB/6/PO/2

(between 2 adjoining terminal blocks)



or

SCB/6/PO/4

(between 4 adjoining terminal blocks)



and by the relevant

SCB/6/CPM

shunting screws



allow the simultaneous earth connection of the current transformers connected to the terminal blocks themselves, guaranteeing the correct operational sequence. In fact such cross connections, in opened position, avoid the translation on the slide links, already connected in an accident prevention position from the outside; they do not require the insertion of further partitions to separate them from other adjoining cross-connections or terminal blocks, due to the special shape of the insulating body of the terminal block itself.

SCB.6 type terminal blocks have also the possibility to house, upstream and downstream the disconnection, sockets for test plugs, suitable for the withdraw of signals.

In particular the shunts can take place:

- On **SCB/CPM** shunting screws of the short-circuit plates
- On **PSD/P** socket to be screwed directly into the conducting body of the terminal block, in order to perform the shunting function.

The slide-link is formed by two guides, held together by a screw inserted in a glass-shape collar, which allows the elastic blocking and the anti-loosening of the slide-link and is provided with a red protective colouring for the easy positioning of the screwdriver during the disconnection and the easy spotting of the slide-link itself.

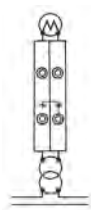

**NORMAL
OPERATION**

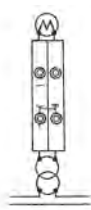

**CT
SHORT-CIRCUIT**

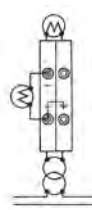

**TEST ON
MEASURING
INSTRUMENT**

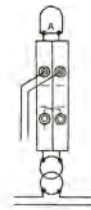

**PROTECTION
INSTRUMENT
TEST**

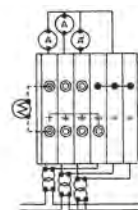

**THREE PHASE
CT TEST**

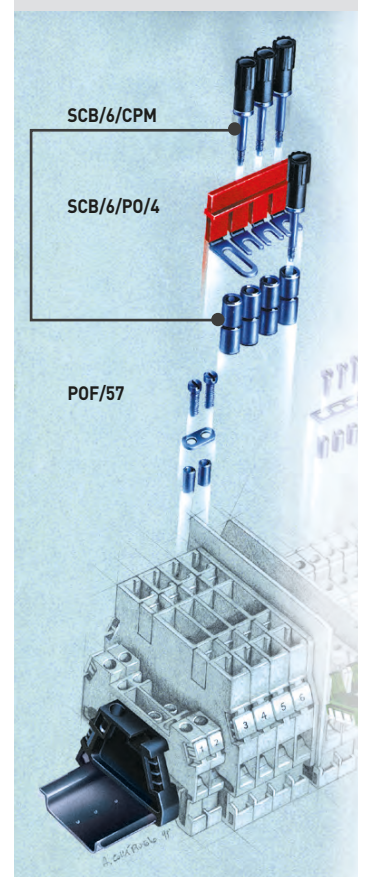

SCREW CLAMP

- configurations prepared /DD (with derivation sockets upstream and downstream of the slide link) - for voltammetric circuits
- configurations prepared /CD (with derivation sockets upstream and downstream of the slide link and sleeve for short circuit upstream of the slide link) - for amperometric circuits

(1) For the simple connection in parallel of two or more adjoining terminal blocks use the parallel skid, with the screw and sleeves, after removing the insulating wall with a simple cutter.
 (2) Longitudinal and trasversal test switching terminal block. Configuration complete with test plug socket downstream and upstream the slide link, compliant with the ENEL LV 27/3 specifications.
 (3) Longitudinal and trasversal test switching terminal block. Configuration complete with test plug socket upstream and a short circuit sleeve SCB/6/PO/2 or SCB/6/PO/4 type, supplied separately, downstream of the slide link, compliant with the ENEL LV 27/3 specifications.

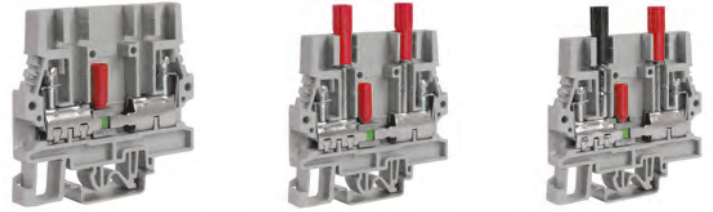

GREY VERSION	CODE	SB200GR	SB210GR	SB220GR
BEIGE VERSION	CODE	SB200	SB210	SB220
	TYPE	SCB.6/GR	SCB.6/DD/GR	SCB.6/CD/GR
	TYPE	SCB.6	SCB.6/DD	SCB.6/CD

TECHNICAL CHARACTERISTICS

Function/type		disconnect by slide link	disconnect by slide link in special configuration for voltmetric circuits [2]	disconnect by slide link in special configuration for amperometric circuits [3]
Rated cross-section	(mm ²)	6	6	6
Connecting capacity	Flexible (mm ²)	0.5-10	0.5-10	0.5-10
	Rigid (mm ²)	0.5-10	0.5-10	0.5-10
	Max. flexible with ferrule - ferrule type (mm ²)	6-WP60/20	6-WP60/20	6-WP60/20
Electrical characteristics According to European standard IEC EN 60947-7-1	Max AC/DC Voltage (V)	800	800	800
	Max current with rated cross-section (A)	41	41	41
	Section Caliber	A5	A5	A5
Electrical characteristics According to UL	Max AC/DC Voltage (V)	600	-	-
	Max current with rated cross-section (A)	47	-	-
	Section Min - Max (AWG)	20 - 8	-	-
	Tightening torque (lb.in)	13.3	-	-
Rated impulse withstand voltage/pollution degree		8 KV / 3	8 KV / 3	8 KV / 3
Insulation stripping length (mm)		12	12	12
Tightening torque value (test / max) (Nm)		0.8 / 1.4	0.8 / 1.4	0.8 / 1.4
Width (mm)		69	69	69
Length (mm)		8	8	8
Height mounted on TH35/7,5 (mm)		65	76	77
Height mounted on TH35/15 (mm)		73	84	85
Height mounted on G32 (mm)		68	79	80
Insulation material temperature index (EN 60216-1) (°C)		130	130	130
Plastic material		polyamide UL94V-0	polyamide UL94V-0	polyamide UL94V-0

APPROVALS



ACCESSORIES

End section	Grey	SCB/6/PT/GR (cod. SB201GR)	SCB/6/PT/GR (cod. SB201GR)	SCB/6/PT/GR (cod. SB201GR)
	Beige	SCB/6/PT (cod. SB201)	SCB/6/PT (cod. SB201)	SCB/6/PT (cod. SB201)
	Thickness (mm)	1.5	1.5	1.5
Permanent cross connection [1]		POF/57 (cod. POF57)	POF/57 (cod. POF57)	POF/57 (cod. POF57)
Multiple common bar	250 mm	PMP/13 (cod. PMP13)	PMP/13 (cod. PMP13)	PMP/13 (cod. PMP13)
Shunting screw and sleeve		CPM/57 (cod. CPM57)	CPM/57 (cod. CPM57)	CPM/57 (cod. CPM57)
Coloured partition	red	DFU/6/R (cod. DU06R)	DFU/6/R (cod. DU06R)	DFU/6/R (cod. DU06R)
Test plug socket		PSD/P (cod. PD015)	2 pcs included	1 pcs included
Test plug		SDD/2 (cod. DD002)	SDD/2 (cod. DD002)	SDD/2 (cod. DD002)
Short-circuit plate	2 poles	SCB/6/PO/2 (cod. SB203)	-	SCB/6/PO/2 (cod. SB203)
	4 poles	SCB/6/PO/4 (cod. SB204)	-	SCB/6/PO/4 (cod. SB204)
Screw and sleeve for short-circuit plates	black	SCB/6/CPM (cod. SB205)	-	1 pcs included
	red	SCB/6/CPM/R (cod. SB205R)	-	-
Marking tag		CNU/8/51 (cod. NU0851S)	CNU/8/51 (cod. NU0851S)	CNU/8/51 (cod. NU0851S)
		CNU/10/61 (cod. NU1061S)	CNU/10/61 (cod. NU1061S)	CNU/10/61 (cod. NU1061S)
End bracket	Snap-fit TH35 and G32	BTU (cod. BT005)	BTU (cod. BT005)	BTU (cod. BT005)
	Snap-fit TH35	BTO (cod. BT007)	BTO (cod. BT007)	BTO (cod. BT007)
	Screw TH35	BT/3 (cod. BT003)	BT/3 (cod. BT003)	BT/3 (cod. BT003)
	Screw G32	BT/DIN/PO (cod. BT001)	BT/DIN/PO (cod. BT001)	BT/DIN/PO (cod. BT001)

- configurations prepared /DD (with derivation sockets upstream and downstream of the slide link) - for voltammetric circuits
- configurations prepared /CD (with derivation sockets upstream and downstream of the slide link and sleeve for short circuit upstream of the slide link) - for amperometric circuits

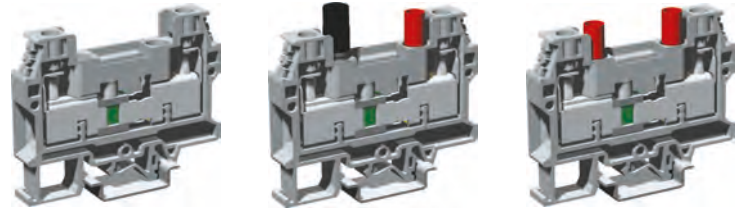

GREY VERSION	CODE	SB400GR	SB410GR	SB420GR
	TYPE	SCB.10/GR	SCB.10/DD/GR	SCB.10/CD/GR
BEIGE VERSION	CODE	SB400	SB410	SB420
	TYPE	SCB.10	SCB.10/DD	SCB.10/CD

TECHNICAL CHARACTERISTICS

Function/type				
Rated cross-section	(mm ²)	10	10	10
Connecting capacity	Flexible (mm ²)	0.5-16	0.5-16	0.5-16
	Rigid (mm ²)	0.5-16	0.5-16	0.5-16
	Max. flexible with ferrule - ferrule type (mm ²)	10-WP100/21	10-WP100/21	10-WP100/21
Electrical characteristics According to European standard IEC EN 60947-7-1	Max AC/DC Voltage (V)	1000	1000	1000
	Max current with rated cross-section (A)	57	57	57
Electrical characteristics According to UL	Section (Caliber)	A4	A4	A4
	Max AC/DC Voltage (V)	-	-	-
	Max current with rated cross-section (A)	-	-	-
	Section Min - Max (AWG)	-	-	-
	Tightening torque (lb.in)	-	-	-
Rated impulse withstand voltage/pollution degree		8 KV / 3	8 KV / 3	8 KV / 3
Insulation stripping length (mm)		14	14	14
Tightening torque value (test / max) (Nm)		1,2 / 1,9	1,2 / 1,9	1,2 / 1,9
Width (mm)		75	-	-
Length (mm)		10.5	10.5	10.5
Height mounted on TH35/7,5 (mm)		59.5	59.5	59.5
Height mounted on TH35/15 (mm)		67.5	67.5	67.5
Height mounted on G32 (mm)		63.5	63.5	63.5
Insulation material temperature index (EN 60216-1) (°C)		130	130	130
Plastic material		polyamide UL94V-0	polyamide UL94V-0	polyamide UL94V-0

APPROVALS



ACCESSORIES

End section	Grey	SCB/10/PT/GR (cod. SB401GR)	SCB/10/PT/GR (cod. SB401GR)	SCB/10/PT/GR (cod. SB401GR)
	Beige	SCB/10/PT (cod. SB401)	SCB/10/PT (cod. SB401)	SCB/10/PT (cod. SB401)
	Thickness (mm)	1.5	1.5	1.5
Permanent cross connection [1]		POF/56 (cod. POF56)	POF/56 (cod. POF56)	POF/56 (cod. POF56)
Multiple common bar 250 mm		PMP/56 (cod. PMP56)	PMP/56 (cod. PMP56)	PMP/56 (cod. PMP56)
Shunting screw and sleeve		CPM/56 (cod. CPM56)	CPM/56 (cod. CPM56)	CPM/56 (cod. CPM56)
Coloured partition red		DFU/7/R (cod. DU07R)	DFU/7/R (cod. DU07R)	DFU/7/R (cod. DU07R)
Test plug socket		PSD/L PD009	2 pcs included	1 pcs included
Test plug		SDD/2 (cod. DD002)	SDD/2 (cod. DD002)	SDD/2 (cod. DD002)
Short-circuit plate	2 poles	SCX/PO/2 (cod. SC103)	-	SCX/PO/2 (cod. SC103)
	4 poles	SCX/PO/4 (cod. SC104)	-	SCX/PO/4 (cod. SC104)
Screw and sleeve for short-circuit plates	black	SCX/CPM (cod. SC105)	-	1 pcs included
	red	-	-	-
Marking tag		CNU/8/51 (cod. NU0851S)	CNU/8/51 (cod. NU0851S)	CNU/8/51 (cod. NU0851S)
		CNU/10/61 (cod. NU1061S)	CNU/10/61 (cod. NU1061S)	CNU/10/61 (cod. NU1061S)
End bracket	Snap-fit TH35 and G32	BTU (cod. BT005)	BTU (cod. BT005)	BTU (cod. BT005)
	Snap-fit TH35	BTO (cod. BT007)	BTO (cod. BT007)	BTO (cod. BT007)
	Screw TH35	BT/3 (cod. BT003)	BT/3 (cod. BT003)	BT/3 (cod. BT003)
	Screw G32	BT/DIN/PO (cod. BT001)	BT/DIN/PO (cod. BT001)	BT/DIN/PO (cod. BT001)

- for 1 A diodes (types 1N4001 – 1N4007)
- for 3 A diodes (type BY 255)

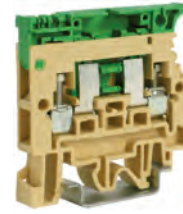
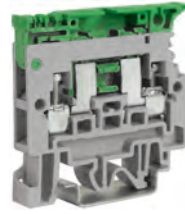

[1] value referred to the insulation characteristics of the terminal block

GREY VERSION	CODE	SFR900GR	SFR901GR	SFR903GR
	TYPE	SFR.4/GR	SFR.4/D1/GR	SFR.4/D3/GR
BEIGE VERSION	CODE	SFR900	SFR901	SFR903
	TYPE	SFR.4	SFR.4/D1	SFR.4/D3

TECHNICAL CHARACTERISTICS

Function/type		for 1 A or 3 A diodes	with 1 A diode	with 3 A diode
Rated cross-section	(mm ²)	4	4	4
Connecting capacity	Flexible	0.2-6	0.2-6	0.2-6
	Rigid	0.2-6	0.2-6	0.2-6
	Max. flexible with ferrule - ferrule type	4-WP40/16	4-WP40/16	4-WP40/16
Electrical characteristics	Max AC/DC Voltage	800 [1]	800 [1]	800 [1]
	Max current with rated cross-section	1 / 3	1	3
According to European standard IEC EN 60947-7-1	Section	Caliber A4	A4	A4
Rated impulse withstand voltage/pollution degree		6 KV (1) / 3	6 KV (1) / 3	6 KV (1) / 3
Insulation stripping length	(mm)	11	11	11
Tightening torque value (test / max)	(Nm)	0.5 / 1.2	0.5 / 1.2	0.5 / 1.2
Width	(mm)	52	52	52
Length	(mm)	8	8	8
Height mounted on TH35/7,5	(mm)	52	52	52
Height mounted on TH35/15	(mm)	60	60	60
Height mounted on G32	(mm)	56	56	56
Insulation material temperature index (EN 60216-1)	(°C)	130	130	130
Plastic material		polyamide UL94V-0	polyamide UL94V-0	polyamide UL94V-0

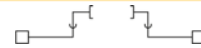

APPROVALS



ACCESSORIES

End section	Grey	SFR.4/PT/GR (cod. SF701GR)	SFR.4/PT/GR (cod. SF701GR)	SFR.4/PT/GR (cod. SF701GR)
	Beige	SFR.4/PT (cod. SF701)	SFR.4/PT (cod. SF701)	SFR.4/PT (cod. SF701)
	Blue	SFR.4/PT (Ex)l (cod. SF801)	SFR.4/PT (Ex)l (cod. SF801)	SFR.4/PT (Ex)l (cod. SF801)
	Thickness	(mm)	1.5	1.5
Coloured partition	red	DFU/3/R (cod. DU03R)	DFU/3/R (cod. DU03R)	DFU/3/R (cod. DU03R)
Miniature fuse	-	-	F5 (cod. FN...)	F5 (cod. FN...)
Cartridge / insert with 1 A diode	-	SFR/I1A (cod. SF992)	-	-
Cartridge / insert with 3 A diode	-	SFR/I3A (cod. SF993)	-	-
Marking tag	-	CNU/8/51 (cod. NU0851S)	CNU/8/51 (cod. NU0851S)	CNU/8/51 (cod. NU0851S)
	-	CNU/10/61 (cod. NU1061S)	CNU/10/61 (cod. NU1061S)	CNU/10/61 (cod. NU1061S)
End bracket	Snap-fit TH35 and G32	BTU (cod. BT005)	BTU (cod. BT005)	BTU (cod. BT005)
	Snap-fit TH35	BTO (cod. BT007)	BTO (cod. BT007)	BTO (cod. BT007)
	Screw TH35	BT/3 (cod. BT003)	BT/3 (cod. BT003)	BT/3 (cod. BT003)
	Screw G32	BT/DIN/PO (cod. BT001)	BT/DIN/PO (cod. BT001)	BT/DIN/PO (cod. BT001)

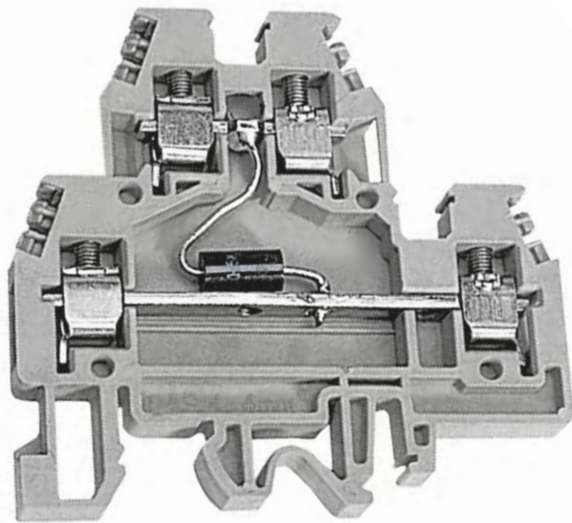

- With cross-connection possibility
- Universal mounting onto both PR/DIN and PR/3 type rails - according to IEC 60715 standard
- Two and three level circuits with bidirectional suppressor diode
- Protection against overvoltage, transient, pulse jamming
- Class D protection according to standard DIN VDE 0675. 1989
- Overvoltage category <math><1.5\text{ kV, I}</math> (DIN VDE 0110.1)
- Available in grey and beige

The **DAS.4...D** terminal blocks with suppressor diodes inserted as in **diagram 3**, limit voltage peaks due to surges, electrostatic discharges and switching of inductive loads, and enable the equipment to pass the tests on immunity to electromagnetic interferences defined by the EN 61000-4-2 (Electrostatic discharge), EN 61000-4-4 (Fast Transient/Burst) and EN 61000-4-5 (Surge Test) Standards. The suppressor diodes have an intervention time (<math><1\text{ ns}</math>) much faster than the intervention time of varistors (approximately 25 ns) and a lower and more precise intervention voltage, but compared to these withstand lower discharge currents.

The great precision of the intervention voltage and the great speed, makes them suitable for protecting industrial PLC, DCS, PC I/O signal ports, against voltage interferences and discharge currents lower than 500A impulse 8/20 μs . This type of interference is usually caused by the normal operation of the plants themselves, owing to the switching of strong inductive loads, dispersed currents, faults, etc...

The range of models available makes it possible to choose between nominal voltages suitable for protecting signals with standard voltages of 5Vdc, 12Vdc, 24Vdc and 60Vdc.

The **DAS.4...D** connected as in **diagram 4** is an effective protection against differential mode interferences for industrial PLC, DCS, PC inputs and outputs, signal conditioners and sensors, and also for stabilised direct current power supplies of electronic equipment in general.

The **DAS.4...D** does not have a signal wiring direction to be observed, as also the connection of the positive and negative polarities can be made either on the lower or the upper level.

Differential mode interference (diagram 5): these generate a great difference of potential between the two conductors of a signal (positive and negative of the twisted pair) or of a power supply, and as they are applied directly to the input/output circuits of the device, they always cause a fault in the same.

Common mode interference (diagram 6): these generate a great difference of potential between the two signal or power supply conductors and the reference earth. They are less destructive than differential mode interferences.

Caution: inserting surge protection devices with varistors, diodes and other components between the signal and/or power supply conductors and the protection earth reduces the insulation voltage approximately to the V breakdown value of the discharger used; to perform insulation tests on the equipment, disconnect the dischargers (IEC EN 60950 Standard).

Note for wiring: wiring of the power surge protection devices greatly influences their actual efficacy and we recommend following the instructions below:

- The protection device must be placed as close as possible to the equipment to be protected;
- The connection wires must be as short and straight as possible, interwoven with each other and with the largest possible cross section;
- The earth conductors between common mode dischargers and the equipotential busbar must be as short as possible and with the largest possible cross section and their path must not be parallel to other conductors. The earth of the protected equipment must be connected to the same earth of its discharger and from there to the general protection earthing.



Schema 3

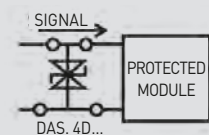

Diagram 4

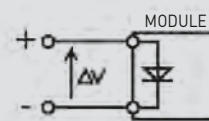

Diagram 5

Differential mode interference. The potential difference is applied between positive and negative poles of the power supply signal.

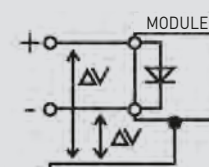

Diagram 6

Common mode interference. The potential difference is applied between the poles of the signal/power supply unit and the earth.

- with cross-connection possibility on lower level
- two and three level circuits with bidirectional suppressor diode
- protection against overvoltage, transistor, pulse jamming
- class D protection according to standard DIN VDE 0675
- overvoltage category <1.5 kV, I (DIN VDE 0110.1)



[1] See chapter accessories for more details

GREY VERSION	CODE	DSD005GR	DSD012GR
	TYPE	DAS.4/D5/6R	DAS.4/D12/6R
BEIGE VERSION	CODE	DSD005	DSD012
	TYPE	DAS.4/D5	DAS.4/D12

TECHNICAL CHARACTERISTICS

Function/type	bidirectional suppressor	bidirectional suppressor
Rated cross-section	(mm ²) 4	4
Connecting capacity	Flexible (mm ²)	0.2-6
	Rigid (mm ²)	0.2-6
	Max. flexible with ferrule - ferrule type (mm ²)	4-WP40/16
Rated voltage	(V) 5	12
Vdc max.	(V) 6.45	15.2
Vac max.	(V) -	-
Breakdown voltage(1 mA)	(V) 6.8 ± 5%	16 ± 5%
Max clamping voltage	(V) 11	23
Response time	(ns) < 1	< 1
ISC pulse /20 µs	(A) 750	350
Capacity (1 kHz)	(nF) 5	3
Insulation stripping length	(mm) 9	9
Tightening torque value (test / max)	(Nm) 0.5 / 1.2	0.5 / 1.2
Width	(mm) 64	64
Length	(mm) 6	6
Height mounted on TH35/7,5	(mm) 62	62
Height mounted on TH35/15	(mm) 70	70
Height mounted on G32	(mm) 66	66
Insulation material temperature index (EN 60216-1)	(°C) 130	130
Plastic material	polyamide UL94V-0	polyamide UL94V-0

APPROVALS



ACCESSORIES			
End section	Grey	DAS/PT/GR (cod. DS101GR)	DAS/PT/GR (cod. DS101GR)
	Beige	DAS/PT (cod. DS101)	DAS/PT (cod. DS101)
	Thickness (mm)	1.5	1.5
Cross connection	(1)	PM/.../... (cod. PM...)	PM/.../... (cod. PM...)
Switchable cross connection		POS/43 (cod. POS43)	POS/43 (cod. POS43)
Multiple common bar	250 mm	PMP/58 (cod. PMP58)	PMP/58 (cod. PMP58)
Shunting screw and sleeve		CPM/01 (cod. CPM01)	CPM/01 (cod. CPM01)
Coloured partition	red	DFU/7/R (cod. DU07R)	DFU/7/R (cod. DU07R)
Test plug socket		PSD/A (cod. PD001)	PSD/A (cod. PD001)
Test plug		SDD/1 (cod. DD001)	SDD/1 (cod. DD001)
Numbering strip		-	-
Cover for cross-connections		PRP/5 (cod. PRP05)	PRP/5 (cod. PRP05)
Marking tag		CNU/8/51 (cod. NU0851S)	CNU/8/51 (cod. NU0851S)
		CNU/10/61 (cod. NU1061S)	CNU/10/61 (cod. NU1061S)
		BTU (cod. BT005)	BTU (cod. BT005)
End bracket	Snap-fit TH35 and G32	BTO (cod. BT007)	BTO (cod. BT007)
	Snap-fit TH35	BT/3 (cod. BT003)	BT/3 (cod. BT003)
	Screw TH35	BT/DIN/PO (cod. BT001)	BT/DIN/PO (cod. BT001)
	Screw G32		

- with cross-connection possibility on lower level
- two and three level circuits with bidirectional suppressor diode
- protection against overvoltage, transistor, pulse jamming
- class D protection according to standard DIN VDE 0675
- overvoltage category <1.5 kV, I (DIN VDE 0110.1)



[1] See chapter accessories for more details

GREY VERSION	CODE	DSD024GR	DSD060GR
	TYPE	DAS.4/D24/GR	DAS.4/D60/GR
BEIGE VERSION	CODE	DSD024	DSD060
	TYPE	DAS.4/D24	DAS.4/D60

TECHNICAL CHARACTERISTICS

Function/type		bidirectional suppressor	bidirectional suppressor
Rated cross-section	(mm ²)	4	4
Connecting capacity	Flexible	(mm ²) 0.2-6	0.2-6
	Rigid	(mm ²) 0.2-6	0.2-6
	Max. flexible with ferrule - ferrule type	(mm ²) 4-WP40/16	4-WP40/16
Rated voltage	(V)	24	60
Vdc max.	(V)	28.5	77.9
Vac max.	(V)	-	-
Breakdown voltage(1 mA)	(V)	30 ± 5%	82 ± 5%
Max clamping voltage	(V)	41	113
Response time	(ns)	< 1	< 1
ISC pulse /20 µs	(A)	160	70
Capacity (1 kHz)	(nF)	1.5	0.6
Insulation stripping length	(mm)	4	9
Tightening torque value (test / max)	(Nm)	0.5 / 1.2	0.5 / 1.2
Width	(mm)	64	64
Length	(mm)	6	6
Height mounted on TH35/7,5	(mm)	62	62
Height mounted on TH35/15	(mm)	70	70
Height mounted on G32	(mm)	66	66
Insulation material temperature index (EN 60216-1)	(°C)	130	130
Plastic material		polyamide UL94V-0	polyamide UL94V-0

APPROVALS



ACCESSORIES			
End section	Grey	DAS/PT/GR (cod. DS101GR)	DAS/PT/GR (cod. DS101GR)
	Beige	DAS/PT (cod. DS101)	DAS/PT (cod. DS101)
	Thickness	(mm) 1.5	1.5
Cross connection	(1)	PM/.../... (cod. PM...)	PM/.../... (cod. PM...)
Switchable cross connection		POS/43 (cod. POS43)	POS/43 (cod. POS43)
Multiple common bar	250 mm	PMP/58 (cod. PMP58)	PMP/58 (cod. PMP58)
Shunting screw and sleeve		CPM/01 (cod. CPM01)	CPM/01 (cod. CPM01)
Coloured partition	red	DFU/7/R (cod. DU07R)	DFU/7/R (cod. DU07R)
Test plug socket		PSD/A (cod. PD001)	PSD/A (cod. PD001)
Test plug		SDD/1 (cod. DD001)	SDD/1 (cod. DD001)
Numbering strip		-	-
Cover for cross-connections		PRP/5 (cod. PRP05)	PRP/5 (cod. PRP05)
Marking tag		CNU/8/51 (cod. NU0851S)	CNU/8/51 (cod. NU0851S)
		CNU/10/61 (cod. NU1061S)	CNU/10/61 (cod. NU1061S)
		BTU (cod. BT005)	BTU (cod. BT005)
End bracket	Snap-fit TH35 and G32	BTO (cod. BT007)	BTO (cod. BT007)
	Snap-fit TH35	BT/3 (cod. BT003)	BT/3 (cod. BT003)
	Screw TH35	BT/DIN/PO (cod. BT001)	BT/DIN/PO (cod. BT001)
	Screw G32		

- two and three level circuits with varistor
- with cross-connection possibility on lower level
- protection against overvoltage, transistor, pulse jamming
- class D protection according to DIN VDE 0675
- overvoltage category <2.5 kV, I (acc. to DIN VDE 0110.1)



[1] See chapter accessories for more details

GREY VERSION	CODE	DSV024GR	DSV048GR
BEIGE VERSION	CODE	DSV024	DSV048
	TYPE	DAS.4/V24/GR	DAS.4/V48/GR
	TYPE	DAS.4/V24	DAS.4/V48

TECHNICAL CHARACTERISTICS

Function/type		two level circuits with varistor	two level circuits with varistor
Rated cross-section	(mm ²)	4	4
Connecting capacity	Flexible	0.2-6	0.2-6
	Rigid	0.2-6	0.2-6
	Max. flexible with ferrule - ferrule type	4-WP40/16	4-WP40/16
Rated voltage	(V)	24	48
Vdc max.	(V)	31	85
Vac max.	(V)	25	60
Breakdown voltage(1 mA)	(V)	39 ± 10%	100 ± 10%
Max clamping voltage	(V)	77	165
Response time	(ns)	< 25	< 25
ISC pulse /20 µs	(A)	500	2500
Capacity (1 kHz)	(nF)	4600	1650
Insulation stripping length	(mm)	9	9
Tightening torque value (test / max)	(Nm)	0.5 / 1.2	0.5 / 1.2
Width	(mm)	64	64
Length	(mm)	6	6
Height mounted on TH35/7,5	(mm)	62	62
Height mounted on TH35/15	(mm)	70	70
Height mounted on G32	(mm)	66	66
Insulation material temperature index (EN 60216-1)	(°C)	130	130
Plastic material		polyamide UL94V-0	polyamide UL94V-0

The DAS.4V... terminal blocks with varistor inserted as in **diagram 1**, limit voltage peaks due to surges, indirect atmospheric discharges and switching of inductive loads, and enable the equipment to pass the tests on immunity to electromagnetic interferences defined by the EN 61000-4-2 (Electrostatic discharge), EN 61000-4-4 (Fast Transient/Burst) and EN 61000-4-5 (Surge Test) Standards.

Varistors have an intervention time (20-25 ns) much longer than the intervention time of suppressor diodes (<1 ns) and a higher intervention voltage, but compared to these withstand higher discharge currents. The high discharge current makes them suitable for use in the presence of strong transients, with currents of up to 4500 A impulse 8/20 s. The range of models available makes it possible to choose between nominal voltages suitable for protecting both signals and power supplies with standard voltages of 24 V DC, 48 V DC, or for power supply voltages of 120 V AC and 230 V AC.

APPROVALS

ACCESSORIES

End section	Grey	DAS/PT/GR (cod. DS101GR)	DAS/PT/GR (cod. DS101GR)
	Beige	DAS/PT (cod. DS101)	DAS/PT (cod. DS101)
	Thickness	(mm) 1.5	1.5
Cross connection	(1)	PM/.../... (cod. PM...)	PM/.../... (cod. PM...)
Switchable cross connection		POS/43 (cod. POS43)	POS/43 (cod. POS43)
Multiple common bar	250 mm	PMP/58 (cod. PMP58)	PMP/58 (cod. PMP58)
Shunting screw and sleeve		CPM/01 (cod. CPM01)	CPM/01 (cod. CPM01)
Coloured partition	red	DFU/7/R (cod. DU07R)	DFU/7/R (cod. DU07R)
Test plug socket		PSD/A (cod. PD001)	PSD/A (cod. PD001)
Test plug		SDD/1 (cod. DD001)	SDD/1 (cod. DD001)
Numbering strip		-	-
Cover for cross-connections		PRP/5 (cod. PRP05)	PRP/5 (cod. PRP05)
Marking tag		CNU/8/51 (cod. NU0851S)	CNU/8/51 (cod. NU0851S)
		CNU/10/61 (cod. NU1061S)	CNU/10/61 (cod. NU1061S)
		BTU (cod. BT005)	BTU (cod. BT005)
End bracket	Snap-fit TH35 and G32	BTO (cod. BT007)	BTO (cod. BT007)
	Snap-fit TH35	BT/3 (cod. BT003)	BT/3 (cod. BT003)
	Screw TH35	BT/DIN/PO (cod. BT001)	BT/DIN/PO (cod. BT001)
	Screw G32		



The DAS.4V... connected as in **diagram 2** is an effective protection against differential mode interferences for industrial PLC, DCS, PC inputs and outputs, signal conditioners and sensors, and also for power supplies of electronic equipment in general.

The DAS.4V... does not have a signal wiring direction to be observed, as also the connection of the positive and negative polarities can be made either on the lower or the upper level.

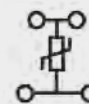

Diagram 1

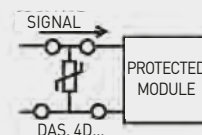

Diagram 2

- two and three level circuits with varistor
- with cross-connection possibility on lower level
- protection against overvoltage, transistor, pulse jamming
- class D protection according to DIN VDE 0675
- overvoltage category <2.5 kV, I (acc. to DIN VDE 0110.1)



[1] See chapter accessories for more details

GREY VERSION	CODE	DSV120GR	DSV230GR
BEIGE VERSION	CODE	DSV120	DSV230
	TYPE	DAS.4/V120/GR	DAS.4/V230/GR
	TYPE	DAS.4/V120	DAS.4/V230

TECHNICAL CHARACTERISTICS

Function/type		two level circuits with varistor	two level circuits with varistor
Rated cross-section	(mm ²)	4	4
Connecting capacity	Flexible	0.2-6	0.2-6
	Rigid	0.2-6	0.2-6
	Max. flexible with ferrule - ferrule type	4-WP40/16	4-WP40/16
Rated voltage	(V)	120	230
Vdc max.	(V)	180	350
Vac max.	(V)	140	275
Breakdown voltage(1 mA)	(V)	220 ± 10%	430 ± 10%
Max clamping voltage	(V)	360	710
Response time	(ns)	< 25	< 25
ISC pulse /20 µs	(A)	2500	2500
Capacity (1 kHz)	(nF)	610	320
Insulation stripping length	(mm)	9	9
Tightening torque value (test / max)	(Nm)	0.5 / 1.2	0.5 / 1.2
Width	(mm)	64	64
Length	(mm)	6	6
Height mounted on TH35/7,5	(mm)	62	62
Height mounted on TH35/15	(mm)	70	70
Height mounted on G32	(mm)	66	66
Insulation material temperature index (EN 60216-1)	(°C)	130	130
Plastic material		polyamide UL94V-0	polyamide UL94V-0

The DAS.4V... terminal blocks with varistor inserted as in **diagram 1**, limit voltage peaks due to surges, indirect atmospheric discharges and switching of inductive loads, and enable the equipment to pass the tests on immunity to electromagnetic interferences defined by the EN 61000-4-2 (Electrostatic discharge), EN 61000-4-4 (Fast Transient/Burst) and EN 61000-4-5 (Surge Test) Standards.

Varistors have an intervention time (20-25 ns) much longer than the intervention time of suppressor diodes (<1 ns) and a higher intervention voltage, but compared to these withstand higher discharge currents. The high discharge current makes them suitable for use in the presence of strong transients, with currents of up to 4500 A impulse 8/20 s. The range of models available makes it possible to choose between nominal voltages suitable for protecting both signals and power supplies with standard voltages of 24 V DC, 48 V DC, or for power supply voltages of 120 V AC and 230 V AC.

APPROVALS

ACCESSORIES

End section	Grey	DAS/PT/GR (cod. DS101GR)	DAS/PT/GR (cod. DS101GR)
	Beige	DAS/PT (cod. DS101)	DAS/PT (cod. DS101)
	Thickness	(mm) 1.5	1.5
Cross connection	(1)	PM/.../... (cod. PM...)	PM/.../... (cod. PM...)
Switchable cross connection		POS/43 (cod. POS43)	POS/43 (cod. POS43)
Multiple common bar	250 mm	PMP/58 (cod. PMP58)	PMP/58 (cod. PMP58)
Shunting screw and sleeve		CPM/01 (cod. CPM01)	CPM/01 (cod. CPM01)
Coloured partition	red	DFU/7/R (cod. DU07R)	DFU/7/R (cod. DU07R)
Test plug socket		PSD/A (cod. PD001)	PSD/A (cod. PD001)
Test plug		SDD/1 (cod. DD001)	SDD/1 (cod. DD001)
Numbering strip		-	-
Cover for cross-connections		PRP/5 (cod. PRP05)	PRP/5 (cod. PRP05)
Marking tag		CNU/8/51 (cod. NU0851S)	CNU/8/51 (cod. NU0851S)
		CNU/10/61 (cod. NU1061S)	CNU/10/61 (cod. NU1061S)
		BTU (cod. BT005)	BTU (cod. BT005)
		BTO (cod. BT007)	BTO (cod. BT007)
End bracket	Snap-fit TH35 and G32	BT/3 (cod. BT003)	BT/3 (cod. BT003)
	Snap-fit TH35	BT/DIN/PO (cod. BT001)	BT/DIN/PO (cod. BT001)
	Screw TH35		
	Screw G32		



The DAS.4V... connected as in **diagram 2** is an effective protection against differential mode interferences for industrial PLC, DCS, PC inputs and outputs, signal conditioners and sensors, and also for power supplies of electronic equipment in general.

The DAS.4V... does not have a signal wiring direction to be observed, as also the connection of the positive and negative polarities can be made either on the lower or the upper level.



Diagram 1

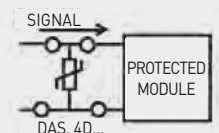
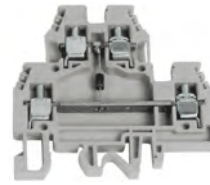

Diagram 2

- two level circuits
- possibility to perform cross-connections on both lower and upper levels (DAS.4/A and DAS.4/B; other versions only lower level)



DEMONSTRATIVE IMAGE



DEMONSTRATIVE IMAGE

(1) See chapter accessories for more details

(2) The voltage and the current ratings given for the various versions are based on the various type of components and to their connections

GREY VERSION	CODE TYPE	DS111GR DAS.4/A/GR	DS112GR DAS.4/B/GR
BEIGE VERSION	CODE TYPE	DS111 DAS.4/A	DS112 DAS.4/B

TECHNICAL CHARACTERISTICS

Function/type		protection against reversal of power supply polarity	protection against reversal of power supply polarity
Rated cross-section	(mm ²)	4	4
Connecting capacity	Flexible (mm ²)	0,2 ÷ 6	0,2 ÷ 6
	Rigid (mm ²)	0,2 ÷ 6	0,2 ÷ 6
	Max. flexible with ferrule - ferrule type (mm ²)	4 - WP40/16	4 - WP40/16
Electrical characteristics According to European standard IEC EN 60947-7-1	Max AC/DC Voltage (V)	630 (2)	630 (2)
	Max current with rated cross-section (A)	1	1
Electrical characteristics According to UL	Section Caliber	A4	A4
	Max AC/DC Voltage (V)	600	600
	Max current with rated cross-section (A)	20	20
	Section Min - Max (AWG)	20 - 12	20 - 12
	Tightening torque (lb.in)	8.9	8.9
Rated impulse withstand voltage/pollution degree		- / 3	- / 3
Insulation stripping length (mm)		9	9
Tightening torque value (test / max) (Nm)		0,5 / 1,2	0,5 / 1,2
Width (mm)		64	64
Length (mm)		6	6
Height mounted on TH35/7,5 (mm)		62	62
Height mounted on TH35/15 (mm)		70	70
Height mounted on G32 (mm)		66	66
Insulation material temperature index (EN 60216-1) (°C)		130	130
Plastic material		polyamide UL94V-0	polyamide UL94V-0

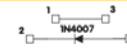
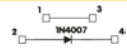

APPROVALS



ACCESSORIES			
End section	Grey	DAS/PT/GR (cod. DS101GR)	DAS/PT/GR (cod. DS101GR)
	Beige	DAS/PT (cod. DS101)	DAS/PT (cod. DS101)
	Thickness (mm)	1.5	1.5
Cross connection		PM/.../... (cod. PM...)	PM/.../... (cod. PM...)
Switchable cross connection		POS/43 (cod. POS43)	POS/43 (cod. POS43)
Multiple common bar		PMP/58 (cod. PMP58)	PMP/58 (cod. PMP58)
Shunting screw and sleeve		CPM/01 (cod. CPM01)	CPM/01 (cod. CPM01)
Coloured partition	red	DFU/7/R (cod. DU07R)	DFU/7/R (cod. DU07R)
Test plug socket		PSD/A (cod. PD001)	PSD/A (cod. PD001)
Test plug		SDD/1 (cod. DD001)	SDD/1 (cod. DD001)
Numbering strip		-	-
Cover for cross-connections		PRP/5 (cod. PRP05)	PRP/5 (cod. PRP05)
Marking tag		CNU/8/51 (cod. NU0851S)	CNU/8/51 (cod. NU0851S)
		CNU/10/61 (cod. NU1061S)	CNU/10/61 (cod. NU1061S)
		BTU (cod. BT005)	BTU (cod. BT005)
End bracket	Snap-fit TH35 and G32	BTU (cod. BT005)	BTU (cod. BT005)
	Snap-fit TH35	BTO (cod. BT007)	BTO (cod. BT007)
	Screw TH35	BT/3 (cod. BT003)	BT/3 (cod. BT003)
	Screw G32	BT/DIN/PO (cod. BT001)	BT/DIN/PO (cod. BT001)

- two level circuits
- possibility to perform cross-connections on both lower and upper levels [DAS.4/A and DAS.4/B; other versions only lower level]



(1) See chapter accessories for more details

(2) The voltage and the current ratings given for the various versions are based on the various type of components and to their connections

GREY VERSION	CODE	DS113GR	DS114GR
	TYPE	DAS.4/C/GR	DAS.4/D/GR
BEIGE VERSION	CODE	DS113	DS114
	TYPE	DAS.4/C	DAS.4/D

TECHNICAL CHARACTERISTICS

Function/type		block of extra current generated by solenoids as coils, relays, valves, supplied in DC.	block of extra current generated by solenoids as coils, relays, valves, supplied in DC.
Rated cross-section	(mm ²)	4	4
Connecting capacity	Flexible (mm ²)	0,2 ÷ 6	0,2 ÷ 6
	Rigid (mm ²)	0,2 ÷ 6	0,2 ÷ 6
	Max. flexible with ferrule - ferrule type (mm ²)	4 - WP40/16	4 - WP40/16
Electrical characteristics According to European standard IEC EN 60947-7-1	Max AC/DC Voltage (V)	630 [2]	630 [2]
	Max current with rated cross-section (A)	1	1
	Section Caliber	A4	A4
Electrical characteristics According to UL	Max AC/DC Voltage (V)	-	-
	Max current with rated cross-section (A)	-	-
	Section Min - Max (AWG)	-	-
	Tightening torque (lb.in)	-	-
Rated impulse withstand voltage/pollution degree		- / 3	- / 3
Insulation stripping length (mm)		9	9
Tightening torque value (test / max) (Nm)		0,5 / 1,2	0,5 / 1,2
Width (mm)		64	64
Length (mm)		6	6
Height mounted on TH35/7,5 (mm)		62	62
Height mounted on TH35/15 (mm)		70	70
Height mounted on G32 (mm)		66	66
Insulation material temperature index (EN 60216-1) (°C)		130	130
Plastic material		polyamide UL94V-0	polyamide UL94V-0

APPROVALS

ACCESSORIES			
End section	Grey	DAS/PT/GR (cod. DS101GR)	DAS/PT/GR (cod. DS101GR)
	Beige	DAS/PT (cod. DS101)	DAS/PT (cod. DS101)
	Thickness (mm)	1.5	1.5
Cross connection		PM/.../... (cod. PM...)	PM/.../... (cod. PM...)
Switchable cross connection		POS/43 (cod. POS43)	POS/43 (cod. POS43)
Multiple common bar		PMP/58 (cod. PMP58)	PMP/58 (cod. PMP58)
Shunting screw and sleeve		CPM/01 (cod. CPM01)	CPM/01 (cod. CPM01)
Coloured partition	red	DFU/7/R (cod. DU07R)	DFU/7/R (cod. DU07R)
Test plug socket		PSD/A (cod. PD001)	PSD/A (cod. PD001)
Test plug		SDD/1 (cod. DD001)	SDD/1 (cod. DD001)
Numbering strip		-	-
Cover for cross-connections		PRP/5 (cod. PRP05)	PRP/5 (cod. PRP05)
Marking tag		CNU/8/51 (cod. NU0851S)	CNU/8/51 (cod. NU0851S)
		CNU/10/61 (cod. NU1061S)	CNU/10/61 (cod. NU1061S)
		BTU (cod. BT005)	BTU (cod. BT005)
End bracket	Snap-fit TH35 and G32	BTU (cod. BT005)	BTU (cod. BT005)
	Snap-fit TH35	BTO (cod. BT007)	BTO (cod. BT007)
	Screw TH35	BT/3 (cod. BT003)	BT/3 (cod. BT003)
	Screw G32	BT/DIN/PO (cod. BT001)	BT/DIN/PO (cod. BT001)

- two level circuits
- possibility to perform cross-connections on both lower and upper levels [DAS.4/A and DAS.4/B; other versions only lower level]



DEMONSTRATIVE IMAGE



DEMONSTRATIVE IMAGE

(1) See chapter accessories for more details

(2) The voltage and the current ratings given for the various versions are based on the various type of components and to their connections

GREY VERSION	CODE TYPE	DS115GR DAS.4/E/GR	DS119GR DAS.4/I/GR
BEIGE VERSION	CODE TYPE	DS115 DAS.4/E	DS119 DAS.4/I

TECHNICAL CHARACTERISTICS

Function/type		For LAMP/LED test circuits	For LAMP/LED test circuits
Rated cross-section	(mm ²)	4	4
Connecting capacity	Flexible (mm ²)	0,2 ÷ 6	0,2 ÷ 6
	Rigid (mm ²)	0,2 ÷ 6	0,2 ÷ 6
	Max. flexible with ferrule - ferrule type (mm ²)	4 - WP40/16	4 - WP40/16
Electrical characteristics According to European standard IEC EN 60947-7-1	Max AC/DC Voltage (V)	20-30	630 [2]
	Max current with rated cross-section (A)	1	1
Electrical characteristics According to UL	Section Caliber	A4	A4
	Max AC/DC Voltage (V)	-	-
	Max current with rated cross-section (A)	-	-
	Section Min - Max (AWG)	-	-
	Tightening torque (lb.in)	-	-
Rated impulse withstand voltage/pollution degree		- / 3	- / 3
Insulation stripping length (mm)		9	9
Tightening torque value (test / max) (Nm)		0,5 / 1,2	0,5 / 1,2
Width (mm)		64	64
Length (mm)		6	6
Height mounted on TH35/7,5 (mm)		62	62
Height mounted on TH35/15 (mm)		70	70
Height mounted on G32 (mm)		66	66
Insulation material temperature index (EN 60216-1) (°C)		130	130
Plastic material		polyamide UL94V-0	polyamide UL94V-0

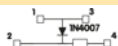

APPROVALS



ACCESSORIES			
End section	Grey	DAS/PT/GR (cod. DS101GR)	DAS/PT/GR (cod. DS101GR)
	Beige	DAS/PT (cod. DS101)	DAS/PT (cod. DS101)
	Thickness (mm)	1.5	1.5
Cross connection		PM/.../... (cod. PM...)	PM/.../... (cod. PM...)
Switchable cross connection		POS/43 (cod. POS43)	POS/43 (cod. POS43)
Multiple common bar		PMP/58 (cod. PMP58)	PMP/58 (cod. PMP58)
Shunting screw and sleeve		CPM/01 (cod. CPM01)	CPM/01 (cod. CPM01)
Coloured partition	red	DFU/7/R (cod. DU07R)	DFU/7/R (cod. DU07R)
Test plug socket		PSD/A (cod. PD001)	PSD/A (cod. PD001)
Test plug		SDD/1 (cod. DD001)	SDD/1 (cod. DD001)
Numbering strip		-	-
Cover for cross-connections		PRP/5 (cod. PRP05)	PRP/5 (cod. PRP05)
Marking tag		CNU/8/51 (cod. NU0851S)	CNU/8/51 (cod. NU0851S)
		CNU/10/61 (cod. NU1061S)	CNU/10/61 (cod. NU1061S)
		BTU (cod. BT005)	BTU (cod. BT005)
End bracket	Snap-fit TH35 and G32	BTU (cod. BT005)	BTU (cod. BT005)
	Snap-fit TH35	BTO (cod. BT007)	BTO (cod. BT007)
	Screw TH35	BT/3 (cod. BT003)	BT/3 (cod. BT003)
	Screw G32	BT/DIN/PO (cod. BT001)	BT/DIN/PO (cod. BT001)

- two level circuits
- possibility to perform cross-connections on both lower and upper levels [DAS.4/A and DAS.4/B; other versions only lower level]

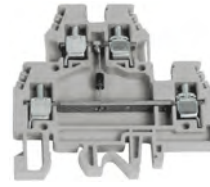

DEMONSTRATIVE IMAGE

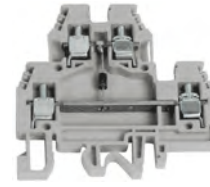

DEMONSTRATIVE IMAGE

(1) See chapter accessories for more details

(2) The voltage and the current ratings given for the various versions are based on the various type of components and to their connections

GREY VERSION	CODE TYPE	DS130GR DAS.4/L/GR	DS120GR DAS.4/DD/GR
BEIGE VERSION	CODE TYPE	DS130 DAS.4/L	DS120 DAS.4/DD

TECHNICAL CHARACTERISTICS

Function/type		For LAMP/LED test circuits	For LAMP/LED test circuits
Rated cross-section	(mm ²)	4	4
Connecting capacity	Flexible (mm ²)	0,2 ÷ 6	0,2 ÷ 6
	Rigid (mm ²)	0,2 ÷ 6	0,2 ÷ 6
	Max. flexible with ferrule - ferrule type (mm ²)	4 - WP40/16	4 - WP40/16
Electrical characteristics According to European standard IEC EN 60947-7-1	Max AC/DC Voltage (V)	630 (2)	630 (2)
	Max current with rated cross-section (A)	1	1
	Section Caliber	A4	A4
Electrical characteristics According to UL	Max AC/DC Voltage (V)	-	-
	Max current with rated cross-section (A)	-	-
	Section Min - Max (AWG)	-	-
	Tightening torque (lb.in)	-	-
Rated impulse withstand voltage/pollution degree		- / 3	- / 3
Insulation stripping length (mm)		9	9
Tightening torque value (test / max) (Nm)		0,5 / 1,2	0,5 / 1,2
Width (mm)		64	64
Length (mm)		6	6
Height mounted on TH35/7,5 (mm)		62	62
Height mounted on TH35/15 (mm)		70	70
Height mounted on G32 (mm)		66	66
Insulation material temperature index (EN 60216-1) (°C)		130	130
Plastic material		polyamide UL94V-0	polyamide UL94V-0

APPROVALS

ACCESSORIES			
End section	Grey	DAS/PT/GR (cod. DS101GR)	DAS/PT/GR (cod. DS101GR)
	Beige	DAS/PT (cod. DS101)	DAS/PT (cod. DS101)
	Thickness (mm)	1,5	1,5
Cross connection		PM/.../... (cod. PM...)	PM/.../... (cod. PM...)
Switchable cross connection		POS/43 (cod. POS43)	POS/43 (cod. POS43)
Multiple common bar		PMP/58 (cod. PMP58)	PMP/58 (cod. PMP58)
Shunting screw and sleeve		CPM/01 (cod. CPM01)	CPM/01 (cod. CPM01)
Coloured partition	red	DFU/7/R (cod. DU07R)	DFU/7/R (cod. DU07R)
Test plug socket		PSD/A (cod. PD001)	PSD/A (cod. PD001)
Test plug		SDD/1 (cod. DD001)	SDD/1 (cod. DD001)
Numbering strip		-	-
Cover for cross-connections		PRP/5 (cod. PRP05)	PRP/5 (cod. PRP05)
Marking tag		CNU/8/51 (cod. NU0851S)	CNU/8/51 (cod. NU0851S)
		CNU/10/61 (cod. NU1061S)	CNU/10/61 (cod. NU1061S)
		BTU (cod. BT005)	BTU (cod. BT005)
End bracket	Snap-fit TH35 and G32	BTU (cod. BT005)	BTU (cod. BT005)
	Snap-fit TH35	BTO (cod. BT007)	BTO (cod. BT007)
	Screw TH35	BT/3 (cod. BT003)	BT/3 (cod. BT003)
	Screw G32	BT/DIN/PO (cod. BT001)	BT/DIN/PO (cod. BT001)

- two level circuits
- possibility to perform cross-connections on both lower and upper levels [DAS.4/A and DAS.4/B; other versions only lower level]

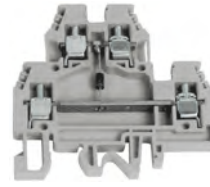

DEMONSTRATIVE IMAGE



DEMONSTRATIVE IMAGE

(1) See chapter accessories for more details

(2) The voltage and the current ratings given for the various versions are based on the various type of components and to their connections

GREY VERSION	CODE TYPE	DS128GR DAS.4/T/GR	DS129GR DAS.4/U/GR
BEIGE VERSION	CODE TYPE	DS128 DAS.4/T	DS129 DAS.4/U

TECHNICAL CHARACTERISTICS

Function/type		voltage indicator	voltage indicator
Rated cross-section	(mm ²)	4	4
Connecting capacity	Flexible (mm ²)	0,2 ÷ 6	0,2 ÷ 6
	Rigid (mm ²)	0,2 ÷ 6	0,2 ÷ 6
	Max. flexible with ferrule - ferrule type (mm ²)	4 - WP40/16	4 - WP40/16
Electrical characteristics According to European standard IEC EN 60947-7-1	Max AC/DC Voltage (V)	20-30	20-30
	Max current with rated cross-section (A)	1	1
Electrical characteristics According to UL	Section Caliber	A4	A4
	Max AC/DC Voltage (V)	-	-
	Max current with rated cross-section (A)	-	-
	Section Min - Max (AWG)	-	-
	Tightening torque (lb.in)	-	-
Rated impulse withstand voltage/pollution degree		- / 3	- / 3
Insulation stripping length (mm)		9	9
Tightening torque value (test / max) (Nm)		0,5 / 1,2	0,5 / 1,2
Width (mm)		64	64
Length (mm)		6	6
Height mounted on TH35/7,5 (mm)		62	62
Height mounted on TH35/15 (mm)		70	70
Height mounted on G32 (mm)		66	66
Insulation material temperature index (EN 60216-1) (°C)		130	130
Plastic material		polyamide UL94V-0	polyamide UL94V-0

APPROVALS

ACCESSORIES		 	
End section	Grey	DAS/PT/GR (cod. DS101GR)	DAS/PT/GR (cod. DS101GR)
	Beige	DAS/PT (cod. DS101)	DAS/PT (cod. DS101)
	Thickness (mm)	1.5	1.5
Cross connection		PM/.../... (cod. PM...)	PM/.../... (cod. PM...)
Switchable cross connection		POS/43 (cod. POS43)	POS/43 (cod. POS43)
Multiple common bar		PMP/58 (cod. PMP58)	PMP/58 (cod. PMP58)
Shunting screw and sleeve		CPM/01 (cod. CPM01)	CPM/01 (cod. CPM01)
Coloured partition	red	DFU/7/R (cod. DU07R)	DFU/7/R (cod. DU07R)
Test plug socket		PSD/A (cod. PD001)	PSD/A (cod. PD001)
Test plug		SDD/1 (cod. DD001)	SDD/1 (cod. DD001)
Numbering strip		-	-
Cover for cross-connections		PRP/5 (cod. PRP05)	PRP/5 (cod. PRP05)
Marking tag		CNU/8/51 (cod. NU0851S)	CNU/8/51 (cod. NU0851S)
		CNU/10/61 (cod. NU1061S)	CNU/10/61 (cod. NU1061S)
		BTU (cod. BT005)	BTU (cod. BT005)
End bracket	Snap-fit TH35 and G32	BTU (cod. BT005)	BTU (cod. BT005)
	Snap-fit TH35	BTO (cod. BT007)	BTO (cod. BT007)
	Screw TH35	BT/3 (cod. BT003)	BT/3 (cod. BT003)
	Screw G32	BT/DIN/PO (cod. BT001)	BT/DIN/PO (cod. BT001)

- with flat push-on tab connections
- 6.3 x 0.8 mm flat push-on tab connections compliant with the IEC 60760 Standard



[1] See chapter accessories for more details

GREY VERSION		CODE TYPE		
BEIGE VERSION		CODE TYPE	AF500	AF400
			AF0.2/1+1	AF0.2/2+2
TECHNICAL CHARACTERISTICS				
Function/type			feed-through with push-on tab connections - separate levels	feed-through with push-on tab connections
Rated cross-section		(mm ²)	2,5	2,5
Connecting capacity		Flexible (mm ²)	up to 2.5	up to 2.5
		Rigid (mm ²)	-	-
		Max. flexible with ferrule - ferrule type (mm ²)	-	-
Electrical characteristics According to European standard IEC EN 60947-7-1		Max AC/DC Voltage (V)	400	630
		Max current with rated cross-section (A)	20	20
		Section Caliber	-	-
Electrical characteristics According to UL		Max AC/DC Voltage (V)	300	600
		Max current with rated cross-section (A)	15	15
		Section Min - Max (AWG)	-	-
		Tightening torque (lb.in)	-	-
Rated impulse withstand voltage/pollution degree			4 KV / 3	6 KV / 3
Insulation stripping length (mm)			-	-
Tightening torque value (test / max) (Nm)			-	-
Width (mm)			44	44
Length (mm)			6.5	6.5
Height mounted on TH35/7,5 (mm)			49	49
Height mounted on TH35/15 (mm)			57	57
Height mounted on G32 (mm)			52	52
Insulation material temperature index (EN 60216-1) (°C)			130	130
Plastic material			polyamide UL94V-0	polyamide UL94V-0
APPROVALS				
ACCESSORIES				
End section		Grey	-	-
		Beige	AF0/PT (cod. AF201)	AF0/PT (cod. AF201)
		Blue	-	-
		Thickness (mm)	1.5	1.5
Cross connection		PTC version [1]	-	-
		PTP version [1]	-	-
		Rated current (A)	-	-
Cross-connection identification strip		green	-	-
Multiple common bar			-	-
Shunting screw and sleeve			-	-
Coloured partition		red	DFU/1/R (cod. DU01R)	DFU/1/R (cod. DU01R)
Perforated barrier		Grey	-	-
		Beige	-	-
Cross connection barrier		red	-	-
Cover for cable lugs			-	-
Flange			-	-
Test plug socket			-	-
Test plug			-	-
Numbering strip			-	-
Marking tag			CNU/8/51 (cod. NU0851S)	CNU/8/51 (cod. NU0851S)
			CNU/10/61 (cod. NU1061S)	CNU/10/61 (cod. NU1061S)
End bracket		Snap-fit TH35 and G32	BTU (cod. BT005)	BTU (cod. BT005)
		Snap-fit TH35	BTO (cod. BT007)	BTO (cod. BT007)
		Screw TH35	BT/3 (cod. BT003)	BT/3 (cod. BT003)
		Screw G32	BT/DIN/PO (cod. BT001)	BT/DIN/PO (cod. BT001)

- with flat push-on tab connections
- 6.3 x 0.8 mm flat push-on tab connections compliant with the IEC 60760 Standard

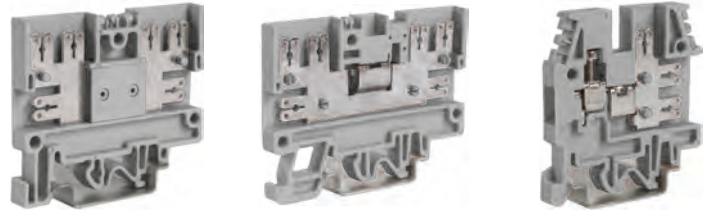

[1] See chapter accessories for more details

GREY VERSION	CODE TYPE	PF100GR	PDF.2/GR	FD100GR	FDP.2/GR	CV100GR	CVF.4/GR
BEIGE VERSION	CODE TYPE	PF100	PDF.2	FD100	FDP.2	CV100	CVF.4

TECHNICAL CHARACTERISTICS

Function/type		feed-through for push-on tab connections	feed-through for push-on tab connections	feed-through 1 screw and 3-push-on connections
Rated cross-section	(mm ²)	2.5	2.5	4
Connecting capacity	Flexible (mm ²)	up to 2.5	up to 2.5	up to 2.5
	Rigid (mm ²)	-	-	-
	Max. flexible with ferrule - ferrule type (mm ²)	-	-	-
Electrical characteristics According to European standard IEC EN 60947-7-1	Max AC/DC Voltage (V)	630	800	800
	Max current with rated cross-section (A)	20	20	20
	Section (Caliber)	-	-	-
Electrical characteristics According to UL	Max AC/DC Voltage (V)	600	600	-
	Max current with rated cross-section (A)	16	16	20
	Section Min - Max (AWG)	20-10	20-10	20-10
	Tightening torque (lb.in)	-	-	-
Rated impulse withstand voltage/pollution degree		6 KV / 3	8 KV / 3	6 KV / 3
Insulation stripping length (mm)		-	-	11
Tightening torque value (test / max) (Nm)		-	-	0,5 / 1,2
Width (mm)		57	65.5	48.5
Length (mm)		6.5	6.5	6
Height mounted on TH35/7,5 (mm)		50	49	52
Height mounted on TH35/15 (mm)		58	57	60
Height mounted on G32 (mm)		54	53	56
Insulation material temperature index (EN 60216-1) (°C)		130	130	130
Plastic material		polyamide UL94V-0	polyamide UL94V-0	polyamide UL94V-0

APPROVALS

ACCESSORIES

End section	Grey	PDF/PT/GR (cod. PF101GR)	FDP/PT/GR (cod. FD101GR)	CVF/PT/GR (cod. CV101GR)
	Beige	PDF/PT (cod. PF101)	FDP/PT (cod. FD101)	CVF/PT (cod. CV101)
	Blue	-	-	CVF/PT (Ex)I (cod. CV201)
	Thickness (mm)	1.5	1.5	1.5
Cross connection	PTC version [1]	-	PH/2.5-4 (cod. PH100)	PM/.../... (cod. PM...)
	PTP version [1]	-	-	-
	Rated current (A)	-	-	-
Cross-connection identification strip	green	-	-	-
Multiple common bar		-	-	PMP/58 (cod. PMP58)
Shunting screw and sleeve		-	-	CPM/12 (cod. CPM12)
Coloured partition	red	DFU/5/R (cod. DU05R)	DFU/5/R (cod. DU05R)	DFU/3/R (cod. DU03R)
Perforated barrier	Grey	-	-	-
	Beige	-	-	-
Cross connection barrier	red	-	-	-
Cover for cable lugs		-	-	-
Flange		-	-	-
Test plug socket		-	-	PSD/A (cod. PD001)
Test plug		-	-	SDD/1 (cod. DD001)
Numbering strip		-	-	CNU/8/61/S (cod. NU0861S)
Marking tag		CNU/8/51 (cod. NU0851S)	CNU/8/51 (cod. NU0851S)	CNU/8/51 (cod. NU0851S)
		CNU/10/61 (cod. NU1061S)	CNU/10/61 (cod. NU1061S)	CNU/10/61 (cod. NU1061S)
End bracket	Snap-fit TH35 and G32	BTU (cod. BT005)	BTU (cod. BT005)	BTU (cod. BT005)
	Snap-fit TH35	BTO (cod. BT007)	BTO (cod. BT007)	BTO (cod. BT007)
	Screw TH35	BT/3 (cod. BT003)	BT/3 (cod. BT003)	BT/3 (cod. BT003)
	Screw G32	BT/DIN/PO (cod. BT001)	BT/DIN/PO (cod. BT001)	BT/DIN/PO (cod. BT001)

SCREW CLAMP

- for female connectors pitch 5.08 mm
- double possible insertion of the "Easy Bridge" multi-polar connection - PTC cross connection



[1] See chapter accessories for more details

For the isolation figures with cross connections refer to the table on page 131

GREY VERSION	CODE	VP300GR
	TYPE	VPC.2/GR
BLUE VERSION	CODE	VP310
	TYPE	VPC.2 (EX)I

TECHNICAL CHARACTERISTICS

Function/type		1 screw connection and 2 pins or female connectors
Rated cross-section	(mm ²)	2.5
Connecting capacity	Flexible (mm ²)	0.2-4
	Rigid (mm ²)	0.2-4
	Max. flexible with ferrule - ferrule type (mm ²)	2.5-WP25/14
Electrical characteristics According to European standard IEC EN 60947-7-1	Max AC/DC Voltage (V)	320
	Max current with rated cross-section (A)	24 - 12
	Section (Caliber)	A3
Electrical characteristics According to UL	Max AC/DC Voltage (V)	600
	Max current with rated cross-section (A)	15
	Section Min - Max (AWG)	20-14
	Tightening torque (lb.in)	5.5
Rated impulse withstand voltage/pollution degree		4 KV / 3
Insulation stripping length	(mm)	9
Tightening torque value (test / max)	(Nm)	0,4 / 0,8
Width	(mm)	44
Length	(mm)	5.08
Height mounted on TH35/7,5	(mm)	51
Height mounted on TH35/15	(mm)	59
Height mounted on G32	(mm)	55
Insulation material temperature index (EN 60216-1)	(°C)	130
Plastic material		polyamide UL94V-0

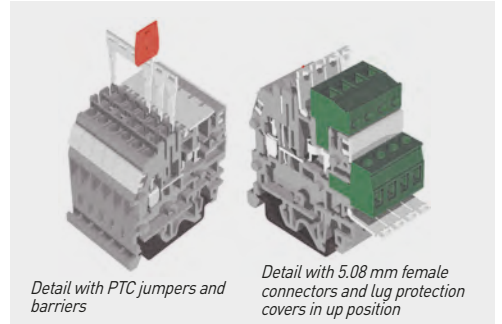

5.08 mm pitch female connectors are available – 90°, with number of poles from 2 up to 16. The connector is easily inserted pressing it up to the stop position, guaranteeing optimal connection on the male contact. In this position the connector is hooked onto the insulating body with the holding tooth with which it is fitted.

APPROVALS



ACCESSORIES

End section	Grey	VPC/PT/GR (cod. VP101GR)
	Beige	VPC/PT (cod. VP101)
	Blue	VPC/PT (Ex)I (cod. VP201)
	Thickness (mm)	1.5
Cross connection	PTC version [1]	PTC/2/... (cod. PTC02...)
	PTP version [1]	
	Rated current (A)	24
Cross-connection identification strip	green	PTC/SP (cod. PTC0990)
Multiple common bar		-
Shunting screw and sleeve		-
Coloured partition	red	DFU/5/R (cod. DU05R)
Perforated barrier	Grey	DF/VPC/GR (cod. DU02SGR)
	Beige	DF/VPC (cod. DU02S)
Cross connection barrier	red	DFM/300 (cod. DF300)
Cover for cable lugs		VPC/VT (cod. VP102)
Flange		VPC/PTF (cod. VP303)
Test plug socket		-
Test plug		-
Numbering strip		-
Marking tag		CNU/8/51 (cod. NU0851S)
		CNU/10/61 (cod. NU1061S)
		BTU (cod. BT005)
End bracket	Snap-fit TH35 and G32	BTO (cod. BT007)
	Snap-fit TH35	BT/3 (cod. BT003)
	Screw TH35	BT/DIN/PO (cod. BT001)
	Screw G32	

VPC/F02	2 poles	Cat. No.	VP902
VPC/F03	3 poles	Cat. No.	VP903
VPC/F04	4 poles	Cat. No.	VP904
VPC/F05	5 poles	Cat. No.	VP905
VPC/F06	6 poles	Cat. No.	VP906
VPC/F07	7 poles	Cat. No.	VP907
VPC/F08	8 poles	Cat. No.	VP908
VPC/F09	9 poles	Cat. No.	VP909
VPC/F10	10 poles	Cat. No.	VP910
VPC/F11	11 poles	Cat. No.	VP911
VPC/F12	12 poles	Cat. No.	VP912
VPC/F13	13 poles	Cat. No.	VP913
VPC/F14	14 poles	Cat. No.	VP914
VPC/F15	15 poles	Cat. No.	VP915
VPC/F16	16 poles	Cat. No.	VP916



VPC/PTF
Flange for the securing of female connectors provided with locking screws onto the terminal board



DF/VPC
reduced pitch end section for the separation of different groups

For even more secure fixing of the connector it is possible to use connectors specifically fitted with locking screws on the side. In this case it is necessary to place a VPC/PTF (code VP303) flange alongside, to the right and left of the block of VPC.2 terminal blocks. If the set thus made up proposes a flange with external connection stalks it is necessary to add a VPC/PT terminal plate, or to eliminate the stalks themselves using a cutter. For reasons of safety the connectors must be handled only in the absence of load. Use of the barrier DF/VPC (code DU02S), for physical and/or visual separation of blocks of terminal blocks, does not affect the possibility of creating parallel cross connections. The terminal block can be supplied also in the version with a warning light (VPC/L024). In this case a collector bar (dimensions 7 x 1 x 250 mm), for the common return of a LED (red - 24V), must be inserted in the specific seat on the side of the insulating body of the group of terminal blocks side-by-side and connected via a power supply terminal block VPC.2 (Ex)I/D (code VP400). The power supply terminal block VPC.2 (Ex)I/D is a variant of the VPC.2(Ex)I terminal block equipped with a diode 1N4007. A transparent cover to protect the male shanks from accidental contacts is supplied as an accessory (VPC/VT code VP102) in a 10-pole stick, easily dividable to obtain the number of poles necessary. It snaps into the special seat provided on the insulating bar; the insertion point works as a fulcrum for the rotation of the protection from the closed position (position which is guaranteed by a stopper) to open (for inserting the connector). It is made of transparent material to ensure a view of both the connection type (closed pos.) and the LED, in open position and with the connector inserted.

- for female connectors pitch 5.08 mm – on 2 levels
- double possible insertion of the “Easy Bridge” multi-polar connection - PTC cross connection



[1] See chapter accessories for more details

GREY VERSION	CODE	VP500GR
	TYPE	VPD.2/GR
BLUE VERSION	CODE	VP560
	TYPE	VPD.2 (EX)I

TECHNICAL CHARACTERISTICS

Function/type		2 level feed-through with 2 screw connections and 2 pins for connectors
Rated cross-section	(mm ²)	2.5
Connecting capacity	Flexible	(mm ²) 0.2-4
	Rigid	(mm ²) 0.2-4
	Max. flexible with ferrule - ferrule type	(mm ²) 2.5-WP25/14
Electrical characteristics According to European standard IEC EN 60947-7-1	Max AC/DC Voltage	(V) 320
	Max current with rated cross-section	(A) 24 - 12
Electrical characteristics According to UL	Section	Caliber A3
	Max AC/DC Voltage	(V) 300
	Max current with rated cross-section	(A) 15
	Section Min - Max	(AWG) 26-12
	Tightening torque	(lb.in) 3.5
Rated impulse withstand voltage/pollution degree		4 KV / 3
Insulation stripping length	(mm)	9
Tightening torque value (test / max)	(Nm)	0,4 / 0,8
Width	(mm)	74
Length	(mm)	5.08
Height mounted on TH35/7,5	(mm)	64
Height mounted on TH35/15	(mm)	72
Height mounted on G32	(mm)	-
Insulation material temperature index (EN 60216-1)	(°C)	130
Plastic material		polyamide UL94V-0

APPROVALS



ACCESSORIES		
End section	Grey	VPD/PT/GR (cod. VP501GR)
	Beige	VPD/PT (cod. VP501)
	Blue	VPD/PT (EX)I (cod. VP561)
	Thickness (mm)	1.5
Cross connection	PTC version [1]	PTC/2/... (cod. PTC02...)
	Rated current (A)	24
Cross-connection identification strip	green	PTC/SP (cod. PTC0990)
Multiple common bar		-
Shunting screw and sleeve		-
Coloured partition	red	DFU/7/R (cod. DU07R)
Perforated barrier	Grey	-
	Beige	-
Cross connection barrier	red	DFM/300 (cod. DF300)
Cover for cable lugs		VPD/VT (cod. VP502)
Flange		-
Test plug socket		-
Test plug		-
Numbering strip		-
Marking tag		CNU/8/51 (cod. NU0851S)
		CNU/10/61 (cod. NU1061S)
End bracket	Snap-fit TH35 and G32	BTU (cod. BT005)
	Snap-fit TH35	BTO (cod. BT007)
	Screw TH35	BT/3 (cod. BT003)
	Screw G32	-

For the isolation figures with cross connections refer to the table on page 131

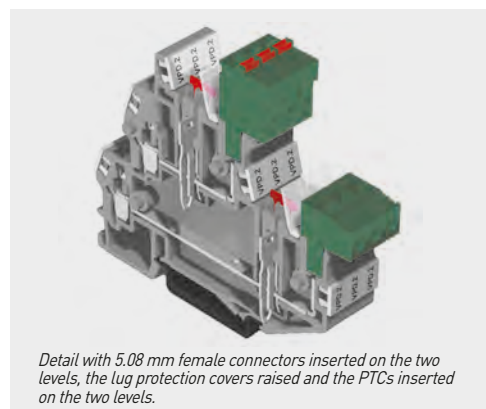

Detail with 5.08 mm female connectors inserted on the two levels, the lug protection covers raised and the PTCs inserted on the two levels.

5.08 mm pitch - 90° female connectors are available, with from 2 up to 16 poles. The connector is easily inserted pressing it up to the stop position, guaranteeing optimal connection on the male contact. In this position the connector is hooked onto the insulating body with the holding tooth, with which it is fitted.

VPC/F02	2 poles	Cat. No.	VP902
VPC/F03	3 poles	Cat. No.	VP903
VPC/F04	4 poles	Cat. No.	VP904
VPC/F05	5 poles	Cat. No.	VP905
VPC/F06	6 poles	Cat. No.	VP906
VPC/F07	7 poles	Cat. No.	VP907
VPC/F08	8 poles	Cat. No.	VP908
VPC/F09	9 poles	Cat. No.	VP909
VPC/F10	10 poles	Cat. No.	VP910
VPC/F11	11 poles	Cat. No.	VP911
VPC/F12	12 poles	Cat. No.	VP912
VPC/F13	13 poles	Cat. No.	VP913
VPC/F14	14 poles	Cat. No.	VP914
VPC/F15	15 poles	Cat. No.	VP915
VPC/F16	16 poles	Cat. No.	VP916

• for thermocouple circuits



CESI 01 ATEX 090 U
I M2 Ex eb I Mb
II 2 G Ex eb IIC Gb

IECEX CES 09.0009U
Ex eb I Mb
Ex eb IIC Gb



BEIGE VERSION	CODE	TC500GR
	TYPE	TC/PO
GREY VERSION	CODE	TC500
	TYPE	TC/PO/GR
BLUE VERSION	CODE	TC510
	TYPE	TC/PO [EX]

TECHNICAL CHARACTERISTICS

Function/type		for thermocouple circuits
Rated cross-section	(mm ²)	-
Connecting capacity	Flexible	(mm ²) -
	Rigid	(mm ²) 0.8 - 1.3 mm thermocouples
	Max. flexible with ferrule - ferrule type	(mm ²) -
Electrical characteristics According to European standard IEC EN 60947-7-1	Max AC/DC Voltage	(V) 800
	Max current with rated cross-section	(A) -
	Section	Caliber -
Electrical characteristics According to UL	Max AC/DC Voltage	(V) 600
	Max current with rated cross-section	(A) 15
	Section Min - Max	[AWG] 20 - 14
	Tightening torque	(lb.in) 5.5
Electrical characteristics According to ATEX directive and IEC ex standard	Max AC/DC voltage with G32 rail / TH35 rail	(V) 400 / 630
	Max current with rated cross-section	(A) <1
	Operating temperature	(°C) -40 +110
Rated impulse withstand voltage/pollution degree		8 KV / 3
Insulation stripping length	(mm)	13
Tightening torque value (test / max)	(Nm)	0,4 / 0,8
Width	(mm)	40.5
Length	(mm)	5.5
Height mounted on TH35/7,5	(mm)	47
Height mounted on TH35/15	(mm)	55
Height mounted on G32	(mm)	51
Insulation material temperature index (EN 60216-1)	(°C)	130
Plastic material		polyamide UL94V-0



APPROVALS

ACCESSORIES

End section	Grey	CB2/PT (cod. CB111)
	Beige	CB2/PT/GR (cod. CB111GR)
	Blue	CB2/PT [Ex]i (cod. CBX13)
	Thickness	(mm) 1.5
Coloured partition	red	DFU/1/R (cod. DU01R)
Marking tag		CNU/8/51 (cod. NU0851S)
		CNU/10/61 (cod. NU1061S)
End bracket	Snap-fit TH35 and G32	BTU (cod. BT005)
	Snap-fit TH35	BTO (cod. BT007)
	Screw TH35	BT/3 (cod. BT003)
	Screw G32	BT/DIN/PO (cod. BT001)



Terminal block suitable for connecting any type of conductor for thermocouple circuits. In fact it is possible, thanks to the excellent electrical contact that results from it, **to clamp thermocouples of any type without interposing any compensation material.**

Besides the management of a single article, this solution permits the reduction of the contact points in the overall circuit. The range of diameters of the conductors connectable, to make the connection in question fully effective and permanent, must be between 0.8 and 1.3 mm.

The thermocouple circuits, also of a different diameter, stripped of the insulating sleeve for a length of 20 mm, must be placed one on top of another in the terminal block so as to enable the direct passage of thermoelectric E.M.F. without going through a metal body, as happens in normal circuits.

With the double clamping, ensured by two screws and by the interposition of the pressure plate, the possibility of EMFs determined by the non-uniformity of the contacts is reduced almost to zero.

• available on request



[1] See chapter accessories for more details

BEIGE VERSION		CODE TYPE	MA100 MAC.6	MA110 CAM
TECHNICAL CHARACTERISTICS				
Function/type			disconnect lever	shunting element
Rated cross-section		(mm ²)	6	2.5
Connecting capacity	Flexible	(mm ²)	0.2-10	0.2-6
	Rigid	(mm ²)	0.2-10	0.2-6
	Max. flexible with ferrule - ferrule type	(mm ²)	6-WP60/20	4-WP40/16
Electrical characteristics According to European standard IEC EN 60947-7-1	Max AC/DC Voltage	(V)	800	800
	Max current with rated cross-section	(A)	16	24
	Section	Caliber	A5	A3
Electrical characteristics According to UL	Max AC/DC Voltage	(V)	600	600
	Max current with rated cross-section	(A)	16	16
	Section Min - Max	(AWG)	20 - 10	20 - 10
	Tightening torque	(lb.in)	13.3	8.9
Rated impulse withstand voltage/pollution degree			8 KV / 3	8 KV / 3
Insulation stripping length		(mm)	14	12
Tightening torque value (test / max)		(Nm)	1.2 / 1.9	-
Width		(mm)	83	-
Length		(mm)	8	-
Height mounted on TH35/7,5		(mm)	65	-
Height mounted on TH35/15		(mm)	73	-
Height mounted on G32		(mm)	69	-
Insulation material temperature index (EN 60216-1)		(°C)	130	130
Plastic material			polyamide UL94V-0	polyamide UL94V-0

APPROVALS



ACCESSORIES			
Shunting connection		-	MAC/COS (cod. MA030)
Polarization insert		-	MAC/PLZ (cod. MA010)
Safety cover		-	MAC/CP8 (cod. MA040)
Cross connection (1)		PIL/... (cod. PIL...)	-
Test plug		SDD/1 (cod. DD001)	-
Pitching strip		MAC/SPS (cod. MA020)	-
Marking tag		CNU/8/51 (cod. NU0851S)	-
		CNU/10/61 (cod. NU1061S)	-
End bracket	Snap-fit TH35 and G32	BTU (cod. BT005)	-
	Snap-fit TH35	BTO (cod. BT007)	-
	Screw TH35	BT/3 (cod. BT003)	-
	Screw G32	BT/DIN/PO (cod. BT001)	-



CESI 03 ATEX 073 U
I M2 Ex eb I Mb
II 2 G Ex eb IIC Gb

IECEX CES 11.0009U
Ex eb I Mb
Ex eb IIC Gb

[1] See chapter accessories for more details

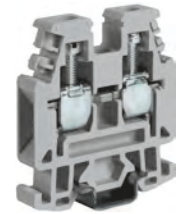

GREY VERSION	CODE	RN300GR	RN500GR	RP300GR
	TYPE	RN.1/GR	RN.2/GR	RP.4/GR
BLUE VERSION	CODE	RN400	RN510	RP400
	TYPE	RN.1 (EX)I	RN.2 (EX)I	RP.4 (EX)I

TECHNICAL CHARACTERISTICS

Function/type		feed-through	feed-through	feed-through
Rated cross-section	(mm ²)	1.5	2.5	4
Connecting capacity	Flexible (mm ²)	0.2-2.5	0.2-4	0.2-6
	Rigid (mm ²)	0.2-2.5	0.2-4	0.2-6
	Max. flexible with ferrule - ferrule type (mm ²)	1.5-WP15/14	2.5-WP25/14	4-WP40/16
Electrical characteristics According to European standard IEC EN 60947-7-1	Max AC/DC Voltage (V)	500	400	630
	Max current with rated cross-section (A)	17.5	24	32
	Section Caliber	A1	A3	A4
Electrical characteristics According to UL	Max AC/DC Voltage (V)	600	300	600
	Max current with rated cross-section (A)	15	20	30
	Section Min - Max (AWG)	26-14	20-12	20-12
	Tightening torque (lb.in)	4.5	3.5	4.4
Electrical characteristics According to ATEX directive and IEC ex standard	Max AC/DC voltage with G32 rail / TH35 rail (V)	-	320	320
	Max current with rated cross-section (A)	-	24	32
	Operating temperature (°C)	-	-40 +110	-40 +110
Rated impulse withstand voltage/pollution degree		6 KV / 3	6 KV / 3	6 KV / 3
Insulation stripping length (mm)		8	8	9
Tightening torque value (test / max) (Nm)		0.4 / 0.8	0.4 / 0.8	0.5 / 1.2
Width (mm)		27	27	31
Length (mm)		4.2	5	6
Height mounted on TH35/15 (mm)		32	32	35
Insulation material temperature index (EN 60216-1) (°C)		130	130	130
Plastic material		polyamide UL94V-0	polyamide UL94V-0	polyamide UL94V-0

APPROVALS



ACCESSORIES				
End section	Grey	RFN/PT/GR (cod. RF101GR)	RFN/PT/GR (cod. RF101GR)	RP4/PT/GR (cod. RP301GR)
	Blue	RFN/PT (Ex)I (cod. RF201)	RFN/PT (Ex)I (cod. RF201)	RP4/PT (Ex)I (cod. RP401)
	Thickness (mm)	1.5	1.5	1.5
Cross connection (1)		PM/11/... (cod. PM11...)	PM/12/... (cod. PM12...)	PM/.../... (cod. PM...)
Multiple common bar	250mm	PMP/16 (cod. PMP16)	PMP/25 (cod. PMP25)	PMP/58 (cod. PMP58)
Shunting screw and sleeve (same, Ex e version)		CPM/16 (cod. CPM16)	CPM/16 (cod. CMP16) - CPX/16 (cod. CPX16)	CPM/01 (cod. CPM01) - CPX/01 (cod. CPX01)
Coloured partition	red	DFP/2/R (cod. DFP2R)	DFP/2/R (cod. DFP2R)	DFP/2/R (cod. DFP2R)
Test plug socket		PSD/K (cod. PD011)	PSD/A (cod. PD001)	PSD/A (cod. PD001)
Test plug		SDD/1 (cod. DD001)	SDD/1 (cod. DD001)	SDD/1 (cod. DD001)
Numbering strip		SNZ/4 (cod. SN008)	CNU/8/51 (cod. NU0851S)	CNU/8/61 (cod. NU0861S)
Warning plate		TQM/02 (cod. TQM02)	-	-
Cover for cross-connection		PRP/5 (cod. PRP05)	PRP/5 (cod. PRP05)	PRP/5 (cod. PRP05)
Marking tag		Please Contact Cabur	CNU/8/51 (cod. NU0851S)	CNU/8/51 (cod. NU0851S)
End bracket	Screw TH15	BT/2 (cod. BT006)	BT/2 (cod. BT006)	BT/2 (cod. BT006)



CESI 03 ATEX 022 U
I M2 Ex eb I Mb
II 2 G Ex eb IIC Gb

IECEX CES 11.0004U
Ex eb I Mb
Ex eb IIC Gb

[1] See chapter accessories for more details

YELLOW/GREEN VERSION		CODE	TR110	TR200
		TYPE	TR.2	TR.4
TECHNICAL CHARACTERISTICS				
Function/type			earth	earth
Rated cross-section		(mm ²)	2,5	4
Connecting capacity	Flexible	(mm ²)	0.2-4	0.2-6
	Rigid	(mm ²)	0.2-4	0.2-6
	Max. flexible with ferrule - ferrule type	(mm ²)	2.5-WP25/14	4-WP40/16
Electrical characteristics According to European standard IEC EN 60947-7-2	Max AC/DC Voltage	(V)	-	-
	Max current with rated cross-section	(A)	-	-
Electrical characteristics According to UL standard	Section	Caliber	A3	A4
	Max AC/DC Voltage	(V)	-	-
	Max current with rated cross-section	(A)	-	-
Electrical characteristics According to ATEX directive and IEC ex standard	Section Min - Max	(AWG)	20-12	20-10
	Tightening torque	(lb.in)	3.5	5.5
	Max AC/DC voltage with G32 rail / TH35 rail	(V)	-	-
	Max current with rated cross-section	(A)	24	32
	Operating temperature	(°C)	-40 +110	-40 +110
Rated impulse withstand voltage/pollution degree			6 KV / 3	6 KV / 3
Insulation stripping length		(mm)	8	9
Tightening torque value (test / max)		(Nm)	0.4 / 0.8	0.5 / 1.2
Width		(mm)	27	35
Length		(mm)	5	7.3
Height mounted on TH35/15		(mm)	32	32
Insulation material temperature index (EN 60216-1)		(°C)	130	130
Plastic material			polyamide UL94V-0	polyamide UL94V-0
APPROVALS				
ACCESSORIES				
End section	Grey		TR.2/PT (cod. TR111)	-
	Blue		-	-
	Thickness	(mm)	1,5	-
Cross connection	(1)		-	-
Multiple common bar	250mm		-	-
Shunting screw and sleeve (same, Ex e version)			-	-
Coloured partition	red		DFP/2/R (cod. DFP2R)	DFP/2/R (cod. DFP2R)
Test plug socket			-	-
Test plug			-	-
Numbering strip			CNU/8/51 (cod. NU0851S)	-
Warning plate			-	-
Cover for cross-connection			-	-
Marking tag			CNU/8/51 (cod. NU0851S)	CNU/8/51 (cod. NU0851S)
			CNU/10/61 (cod. NU1061S)	CNU/10/61 (cod. NU1061S)
End bracket	Screw TH15		BT/2 (cod. BT006)	BT/2 (cod. BT006)

SCREW CLAMP

- to be fixed directly on panel, by means of screws



	CESI 03 ATEX 164 U	IECEX CES 11.0008U
	I M2 Ex eb I Mb	Ex eb I Mb
	II 2 G Ex eb IIC Gb	Ex eb IIC Gb

(1) when using BPL.4 and TPL.4 terminal blocks in Ex e classified installations, the use of the insulated fixing screw is required.

BEIGE VERSION	CODE TYPE	BP100	TP100	BP200
		BPL.4	TPL.4	BPL/R
TECHNICAL CHARACTERISTICS				
Function/type		two-pole	three-pole	two-pole reduced pitch
Rated cross-section	(mm ²)	4	4	4
Connecting capacity	Flexible	0.5-6	0.5-6	0.5-6
	Rigid	0.5-6	0.5-6	0.5-6
	Max. flexible with ferrule - ferrule type	4-WP40/16	4-WP40/16	4-WP40/16
Electrical characteristics According to European standard IEC EN 60947-7-1	Max AC/DC Voltage	500	500	500
	Max current with rated cross-section	32	32	32
	Section	Caliber A4	A4	A4
Electrical characteristics According to UL	Max AC/DC Voltage	300	300	300
	Max current with rated cross-section	20	20	20
	Section Min - Max	12-18	12-18	12-18
	Tightening torque	4.4	4.4	4.4
Electrical characteristics According to ATEX directive and IEC ex standard	Max AC/DC voltage with G32 rail / TH35 rail	320	320	320
	Max current with rated cross-section	32	32	32
	Operating temperature	-40+110	-40+110	-40+110
Rated impulse withstand voltage/pollution degree		6 KV / 3	6 KV / 3	6 KV / 3
Insulation stripping length	(mm)	12	12	12
Tightening torque value (test / max)	(Nm)	0.5 / 0.7	0.5 / 0.7	0.5 / 0.7
Width	(mm)	24	30	24
Length	(mm)	20	20	13
Height	(mm)	26	26	26
Fixing screws	(1)	M3 (Ø head 5.6 mm max)	M3 (Ø head 5.6 mm max)	-
Insulation material temperature index (EN 60216-1)	(°C)	130	130	130
Plastic material		polyamide UL94V-0	polyamide UL94V-0	polyamide UL94V-0

APPROVALS



NORMAL COMPOSITIONS		
Number of poles	BPL.4 and TPL.4 configurations	Total length (mm)
2	B	20
3	T	30
4	B+B	40
5	B+T	50
6	T+T	60
7	B+T+B	70
8	T+B+T	80
9	T+T+T	90
10	T+B+B+T	100
12	T+T+T+T	120
14	T+T+B+T+T	140
15	T+T+T+T+T	150
16	T+T+B+B+T+T	160
18	T+T+T+T+T+T	180
20	T+T+T+B+T+T+T	200

The bipolar BPL.4, BPL/R and tripolar TPL.4 terminal boards can be fixed separately or used to lock together terminal boards with an unlimited number of poles without using supporting rails. The special "dovetail" channels, ensuring the maximum compactness of assembly, make sufficient the use of only two screws for fixing, at the end of the terminal board. The BPL.4, BPL/R and TPL.4 terminal boards are made ready for marking with NU0550-type name tags.

(*) NOTE:
when using BPL.4 and TPL.4 terminal blocks in Ex e classified installations, the use of the insulated fixing screw is required.

- /PS versions have one screw connection and one flat plug feed-through shank (2.3x0.8 mm) usable also for welding
- to be fixed directly on panel, by means of screws



BEIGE VERSION		CODE TYPE	BP300	TP200
			BPL.4/PS	TPL.4/PS
TECHNICAL CHARACTERISTICS				
Function/type			version with special connections (two-pole)	version with special connections (three-pole)
Rated cross-section		(mm ²)	4	4
Connecting capacity	Flexible	(mm ²)	0.5-6	0.5-6
	Rigid	(mm ²)	0.5-6	0.5-6
	Max. flexible with ferrule - ferrule type	(mm ²)	4-WP40/16	4-WP40/16
Electrical characteristics According to European standard IEC EN 60947-7-1	Max AC/DC Voltage	(V)	500	500
	Max current with rated cross-section	(A)	32	32
	Section	Caliber	A4	A4
Electrical characteristics According to UL	Max AC/DC Voltage	(V)	300	300
	Max current with rated cross-section	(A)	20	20
	Section Min - Max	(AWG)	12-18	12-18
	Tightening torque	(lb.in)	4.4	4.4
Electrical characteristics According to ATEX directive and IEC ex standard	Max AC/DC voltage with G32 rail / TH35 rail	(V)	-	-
	Max current with rated cross-section	(A)	-	-
	Operating temperature	(°C)	-	-
Rated impulse withstand voltage/pollution degree			6 KV / 3	6 KV / 3
Insulation stripping length		(mm)	12	12
Tightening torque value (test / max)		(Nm)	0.5 / 0.7	0.5 / 0.7
Width		(mm)	24	24
Length		(mm)	20	20
Height		(mm)	36	36
Fixing screws	(1)		M3 (Ø head 5.6 mm max)	M3 (Ø head 5.6 mm max)
Insulation material temperature index (EN 60216-1)		(°C)	130	130
Plastic material			polyamide UL94V-0	polyamide UL94V-0

APPROVALS



SCREW CLAMP

NORMAL COMPOSITIONS		
Number of poles	BPL.4 and TPL.4 configurations	Total length (mm)
6	B+R+B	53
8	B+R+R+B	66
10	B+R+R+R+B	79
12	B+R+R+R+R+B	92
14	B+R+R+R+R+R+B	105
16	B+R+R+R+R+R+R+B	118
18	B+R+R+R+R+R+R+R+B	131
20	B+R+R+R+R+R+R+R+R+B	144

PS versions, equipped with solder connections are also available in the following configurations:

- **BPL.4/PS (Cat. No. BP300) - TPL.4/PS (Cat. No. TP200)**
equipped with screw connections on the opposite side from the solder connections
- **BPL.4/PS/A (Cat. No. BP310) - TPL.4/PS/A (Cat. No. TP210)**
equipped with screw connections on the same side as the solder connections

- with 6.3 x 0.8 mm flat push-on tab connections (2 for each pole)
- singular or overlapped mounting



BEIGE VERSION WITHOUT END PLATE	CODE	CF100	CF.12/1+1	CF200	CF.12/2+2
	TYPE				
BEIGE VERSION WITH END PLATE	CODE	CF900			
	TYPE		CF.12/CPT		

TECHNICAL CHARACTERISTICS

Function/type		feed- through	feed- through
Rated cross-section	(mm ²)	2.5	2.5
Electrical characteristics According to European standard IEC EN 60947-7-1	Max AC/DC Voltage	(V)	500
	Max current with rated cross-section	(A)	20
Rated impulse withstand voltage/pollution degree		6 KV / 3	6 KV / 3
Width	(mm)	109	109
Length	(mm)	34	34
Height	(mm)	16.5	24
Fixing distance between centers		69.5	69.5
Insulation material temperature index (EN 60216-1)	(°C)	130	130
Plastic material		polyamide UL94V-0	polyamide UL94V-0

APPROVALS

ACCESSORIES			
Upper end section	of beige polyamide	CF/PT	-
Insulating bushing	of beige polyamide	CF/BI	CF/BI
Reduced bushing	made of polyamide	-	CF/BR

The **CF.12/1+1** terminal boards can be mounted singularly or one on top of another. In both cases the single terminal board or the terminal board located at the top of the group must be closed with the CF/PT end platelet (thickness 4 mm). Fixing to the panel beneath can be done using:

- screws of an adequate length (spacing between holes 69.5 mm)
- M4 threaded tension rods

To ensure the maximum insulation from earth and correct mounting of the stacked terminal boards it is necessary to insert the special bushings CF/BI in the holes on the body of the bases. Bushings between the terminal board and the end platelet are not required because the latter is already opportunely shaped.

The above end platelet bears in relief the numbering from 1 to 12 for easy identification of the poles.

The connection plugs, completely protected from the outside and with opportune barriers between them, are made of a copper-zinc alloy, with a high percentage of copper, galvanic anti-rust and anti-corrosive protection in nickel or, on request, in silver (CF.12/1+1/AG Code CFA10).

The **CF.12/2+2** terminal boards can be mounted singularly or one on top of another. Fixing to the panel beneath can be done using:

- screws of an adequate length (spacing between holes 69.5 mm)
- M4 threaded stay bolts

To ensure the maximum insulation from earth and correct mounting of the stacked terminal boards it is necessary to insert the special bushings CF/BI in the holes on the body of the bases. To enable better clamping of the CF/DD nuts, in the case of use of threaded stay bolts, it is opportune to insert in the holes of the upper terminal board the reduced bushings CF.BR.

The **CF.12/2+2** terminal boards bear, on both bases, in relief, the numbering from 1 to 12 for easy identification of the poles.

The connection plugs, completely protected from the outside and with opportune barriers between them, are made of a copper-zinc alloy, with a high percentage of copper, galvanic anti-rust and anti-corrosive protection in nickel or, on request, in silver (CF.12/2+2/AG Code CFA20).

Blank lined area for notes.

Distribution Terminal Boards

- 8-poles, 4 ammetric and 4 voltmetric
- Insulating body: of green polycarbonate, filled with fibreglass.
- Conductor body: components of copper-zinc alloy with high percentage of copper and provided with nickel plating.
- Cover: black polyamide



GREEN VERSION	CODE	MZ300N	MZ300T
	TYPE	MS/8X10/N	MS/8X10/T

TECHNICAL CHARACTERISTICS

Rated cross-section		(mm ²)	10	10
Connecting capacity	Flexible	(mm ²)	0.5-16	0.5-16
Test tightening torque		(Nm)	1.2	1.2
Electrical characteristics According to European standard IEC EN 60947-7-1	Max AC/DC Voltage	(V)	500	500
	Max current with rated cross-section	(A)	57	57
Rated impulse withstand voltage/pollution degree			6 KV / 3	6 KV / 3
Width		(mm)	112	112
Length		(mm)	112	112
Height (with cover/including screws)		(mm)	52 / 65	52 / 65
Space between fixing holes		(mm)	92.5	92.5

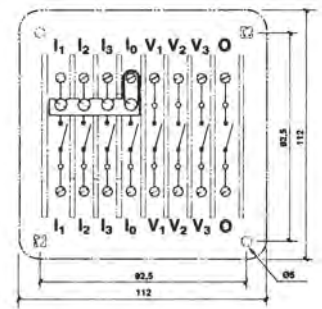
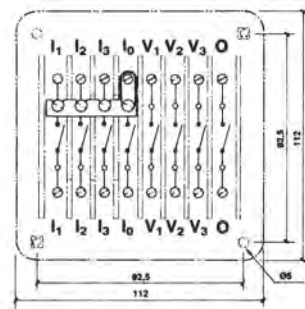

- Available in 7 and 12 hole versions
- Inherent protection against accidental contact IPXXB level according to IEC 60529
- Marking possible with a CNU/8 or CNU/10 tag
- Available in grey, green and blue
- Insulating in polyamide 6.6 UL94V-0



GREY VERSION	CODE	QBLOK7003	QBLOK1203
	TYPE	QBLOK.7/GR	QBLOK.12/GR
BLUE VERSION	CODE	QBLOK7001	QBLOK1201
	TYPE	QBLOK.7/BLU	QBLOK.12/BLU
GREEN VERSION	CODE	QBLOK7002	QBLOK1202
	TYPE	QBLOK.7/TE	QBLOK.12/TE

TECHNICAL CHARACTERISTICS

Function/type		Distribution terminal boards	Distribution terminal boards
Number and diameter of holes		7 holes Ø 5.3 mm	12 holes Ø 5.3 mm
Rated cross-section	(mm ²)	10	10
Connecting capacity	Flexible (mm ²)	1.5–10	1.5–10
	Rigid (mm ²)	1.5–16	1.5–16
	Max.flexible with ferrule - ferrule type (mm ²)	10-WP100/21	10-WP100/21
Electrical characteristics According to European standard IEC EN 60947-7-1	Max AC/DC Voltage (V)	500	500
	Max current with rated cross-section (A)	63	63
	Section (Caliber)	B5	B5
Tightening torque value (test / max)	(Nm)	2 / 2.5	2 / 2.5
Rated impulse withstand voltage/pollution degree		-	-
Insulation stripping length	(mm)	6	6
Width	(mm)	53	85
Length	(mm)	16	16
Height mounted on TH35/7,5	(mm)	33	33
Height mounted on TH35/15	(mm)	41	41

APPROVALS

ACCESSORIES			
Marking tag		CNU/8/51 (cod. NU0851S)	CNU/8/51 (cod. NU0851S)
End bracket	Snap fit TH35 and G32	BTU (cod. BT005)	BTU (cod. BT005)
	Screw TH35	BT/3 (cod. BT003)	BT/3 (cod. BT003)
	Snap fit TH35	BTO (cod. BT007)	BTO (cod. BT007)
Mounting rail according to IEC 60715 Std.		PR/3/AC (cod. PR003)	PR/3/AC (cod. PR003)
		PR/3/AS (cod. PR005)	PR/3/AS (cod. PR005)

- Easy installation, with dovetail side supports for better compression
- Visible conductor input thanks to an innovative design with a graduated brass body
- Universal power supply: conductor or bar
- High number of connection points
- IPXXB according to IEC60529
- Captive tightening screw
- HF self-extinguishing plastic sleeve



VERSIONS	CODE	QBLOK1P160	QBLOK1P250	QBLOK1P400
	TYPE	QBLOK1P160A6	QBLOK1P250A10	QBLOK1P400A10

TECHNICAL CHARACTERISTICS

Number x section of holes		1 x 70mm ² hole	1 x 120mm ² hole	1 x 185mm ² hole	
		2 x 25mm ² holes	2 x 35mm ² holes	2 x 35mm ² holes	
		3 x 16mm ² holes	3 x 25mm ² holes	3 x 25mm ² holes	
		-	4 x 16mm ² holes	4 x 16mm ² holes	
Rated cross-section	(mm ²)	70	120	185	
Connection capacity of power supply hole 185-120-70 mm ² / bar	Flexible	(mm ²)	10 - 70	35 - 120	70 - 185
	Rigid	(mm ²)	10 - 70	35 - 120	70 - 185
	Max.flexible with ferrule - ferrule type	(mm ²)	50 - WP 350/40	-	-
	Power supply bar - L x S	(mm)	15 x 5	24 x 10	24 x 10
Connection capacity of power supply hole 35 mm ²	Flexible	(mm ²)	-	4 - 35	4 - 35
	Rigid	(mm ²)	-	4 - 35	4 - 35
	Max.flexible with ferrule - ferrule type	(mm ²)	-	25 - WP 250/29	50 - WP 250/29
Connection capacity of power supply hole 25 mm ²	Flexible	(mm ²)	2.5 - 25	2.5 - 25	2.5 - 25
	Rigid	(mm ²)	2.5 - 25	2.5 - 25	2.5 - 25
	Max.flexible with ferrule - ferrule type	(mm ²)	16 - WP 160/22	16 - WP 160/22	16 - WP 160/22
Connection capacity of power supply hole 16 mm ²	Flexible	(mm ²)	2.5 - 16	1.5 - 16	1.5 - 16
	Rigid	(mm ²)	2.5 - 16	1.5 - 16	1.5 - 16
	Max.flexible with ferrule - ferrule type	(mm ²)	16 - WP 100/21	16 - WP 100/21	16 - WP 100/21
Electrical characteristics According to European standard IEC EN 60947-7-1	Max AC/DC Voltage	(V)	690	690	690
	Max current with rated cross-section	(A)	160	250	400
	Section	Caliber	-	-	-
Electrical characteristics According to UL	Max AC/DC Voltage	(V)	600	600	600
	Max current with rated cross-section	(A)	160	250	310
	Section Min-Max	(AWG)	8 - 2/0	2 - 250 Kcmil	3/0 - 350 Kcmil
	Thigtening torque	(lb.in)	88.5	168.2	221.3
Short term current allowed (I _{cw}) (value effective for 1s)	(kA)	-	-	-	
Peak current (ICC)	(kA)	8.4	14.4	22.4	
Rated impulse withstand voltage / degree of pollution		8kV / 3	8kV / 3	8kV / 3	
Insulation stripping lenght	(mm)	17/12/12	27 / 18 / 12	27 / 18 / 12	
	(Nm)	10 for the (70mm ²)	19 for the (120mm ²)	19 for the (185mm ²)	
Tightening torque	(Nm)	3 for the (25 and 16 mm ²)	6 for the (35mm ²)	6 for the (35mm ²)	
	(Nm)	-	3 for the (25 and 16 mm ²)	3 for the (25 and 16 mm ²)	
Width		90	90	90	
Thickness		41.6	51	51	
Height on TH/35 7.5 mm		51	68	68	
Height on TH/35 15 mm		59	75	75	
Quantity per pack		1	1	1	

APPROVALS

- bipolar distribution terminal board
- Easy installation
- Insulating screen for each conducting busbar
- Power supply holes intentionally offset to simplify wiring
- Conforming to EN 60947-7-1
- Zinc-plated steel screws with combined single-slot
- Transparent polycarbonate, self-extinguishing



VERSIONS	CODE	QBLOK2100	QBLOK2125	QBLOK2126
	TYPE	QBLOK2P100A7	QBLOK2P125A11	QBLOK2P125A15

TECHNICAL CHARACTERISTICS				
Number and diameter of holes		2 x 7.5 mm holes	2 x 9 mm holes	2 x 9 mm holes
		5 x 5.4 mm holes	2 x 7.5 mm holes	2 x 7.5 mm holes
Rated cross-section		-	7 x 5.4 mm holes	11 x 5.4 mm holes
	(mm ²)	25	35	35
Connecting capacity of power supply hole 9 mm	Flexible	(mm ²)	-	10-35
	Rigid	(mm ²)	-	10-35
	Max.flexible with ferrule - ferrule type	(mm)	-	25-WP 250/29
Connecting capacity of power supply hole 7.5 mm	Flexible	(mm ²)	10-25	10-25
	Rigid	(mm ²)	10-25	10-25
	Max.flexible with ferrule - ferrule type	(mm)	16-WP 160/22	16-WP 160/22
Connecting capacity of power supply hole 5.4 mm	Flexible	(mm ²)	2.5 - 6	2.5 - 6
	Rigid	(mm ²)	2.5 - 6	2.5 - 6
	Max.flexible with ferrule - ferrule type	(mm)	4-WP 40/16	4-WP 40/16
Electrical characteristics According to European standard IEC EN 60947-7-1	Max AC/DC Voltage	(V)	1000	1000
	Max current with rated cross-section	(A)	100	125
	Section	Caliber	-	-
Short term current allowed (I _{cw}) (value effective for 1s)	(kA)	6	3	3
Peak current according to EN 60947-1 (ICC)	(kA)	20	19	19
Rated impulse withstand voltage / degree of pollution		8kV / 3	8kV / 3	8kV / 3
Insulation stripping length	(mm)	13	13	13
Tightening torque	(Nm)	2 / 2.5	2 / 2.5	2 / 2.5
Width		49	49	49
Thickness		72	109	137
Height on TH/35 7.5 mm		52	52	52
Height on TH/35 15 mm		59	59	59
Quantity for package		4	2	2

APPROVALS			
-----------	--	--	--

ACCESSORIES				
Marking tag		CNU/8/51 (cod. NU0851S)	CNU/8/51 (cod. NU0851S)	CNU/8/51 (cod. NU0851S)
End bracket	Snap-fit TH35 and G32	BTU (cod. BT005)	BTU (cod. BT005)	BTU (cod. BT005)
	Snap-fit TH35	BTO (cod. BT007)	BTO (cod. BT007)	BTO (cod. BT007)
	Screw TH35	BT/3 (cod. BT003)	BT/3 (cod. BT003)	BT/3 (cod. BT003)

- four-pole distribution terminal boards
- Easy installation
- Insulating screen for each conducting busbar
- Power supply holes intentionally offset to simplify wiring
- Conforming to EN 60947-7-1
- Zinc-plated steel screws with combined single-slot
- Transparent polycarbonate, self-extinguishing



VERSIONS	CODE	QBLOK4100	QBLOK4125	QBLOK4126
	TYPE	QBLOK4P100A7	QBLOK4P125A11	QBLOK4P125A15

TECHNICAL CHARACTERISTICS

Number and diameter of holes		2 x 7.5 mm holes	2 x 9 mm holes	2 x 9 mm holes
		5 x 5.4 mm holes	2 x 7.5 mm holes	2 x 7.5 mm holes
Rated cross-section		-	7 x 5.4 mm holes	11 x 5.4 mm holes
	(mm ²)	25	35	345
Connecting capacity of power supply hole 9 mm	Flexible	(mm ²)	-	10-35
	Rigid	(mm ²)	-	10-35
	Max.flexible with ferrule - ferrule type	(mm)	-	25-WP 250/29
Connecting capacity of power supply hole 7.5 mm	Flexible	(mm ²)	10-25	10-25
	Rigid	(mm ²)	10-25	10-25
	Max.flexible with ferrule - ferrule type	(mm)	16-WP 160/22	16-WP 160/22
Connecting capacity of power supply hole 5.4 mm	Flexible	(mm ²)	2.5 - 6	2.5 - 6
	Rigid	(mm ²)	2.5 - 6	2.5 - 6
	Max.flexible with ferrule - ferrule type	(mm)	4-WP 40/16	4-WP 40/16
Electrical characteristics According to European standard IEC EN 60947-7-1	Max AC/DC Voltage	(V)	500	500
	Max current with rated cross-section	(A)	100	125
	Section	Caliber	-	-
Short term current allowed (I _{cw}) (value effective for 1s)	(kA)	6	3	3
Peak current according to EN 60947-1 (ICC)	(kA)	20	19	19
Rated impulse withstand voltage / degree of pollution		8kV / 3	8kV / 3	8kV / 3
Insulation stripping length	(mm)	13	13	13
Tightening torque	(Nm)	2 / 2.5	2 / 2.5	2 / 2.5
Width		97	97	97
Thickness		72	108	137
Height on TH/35 7.5 mm		52	52	52
Height on TH/35 15 mm		59	59	59
Quantity for package		2	1	1

APPROVALS

ACCESSORIES				
Marking tag		CNU/8/51 (cod. NU0851S)	CNU/8/51 (cod. NU0851S)	CNU/8/51 (cod. NU0851S)
End bracket	Snap-fit TH35 and G32	BTU (cod. BT005)	BTU (cod. BT005)	BTU (cod. BT005)
	Snap-fit TH35	BTO (cod. BT007)	BTO (cod. BT007)	BTO (cod. BT007)
	Screw TH35	BT/3 (cod. BT003)	BT/3 (cod. BT003)	BT/3 (cod. BT003)

- four-pole distribution terminal boards
- Easy installation
- Insulating screen for each conducting busbar
- Power supply holes intentionally offset to simplify wiring
- Conforming to EN 60947-7-1
- Zinc-plated steel screws with combined single-slot
- Transparent polycarbonate, self-extinguishing



VERSIONS	CODE	QBLOK4160S	QBLOK4161N
	TYPE	QBLOK4P160A9	QBLOK4P160A14

TECHNICAL CHARACTERISTICS

Number and diameter of holes		1 x 11 mm hole	1 x 11 mm hole
		2 x 8.5 mm holes	4 x 8.5 mm holes
		6 x 6.5 mm holes	9 x 6.5 mm holes
Rated cross-section	(mm ²)	50	50
Connecting capacity of power supply hole 9 mm	Flexible	(mm ²)	10 – 50
	Rigid	(mm ²)	10 – 50
	Max.flexible with ferrule - ferrule type	(mm)	-
Connecting capacity of power supply hole 7.5 mm	Flexible	(mm ²)	10-35
	Rigid	(mm ²)	10-35
	Max.flexible with ferrule - ferrule type	(mm)	25-WP 250/29
Connecting capacity of power supply hole 5.4 mm	Flexible	(mm ²)	2.5-16
	Rigid	(mm ²)	2.5-16
	Max.flexible with ferrule - ferrule type	(mm)	16-WP 160/22
Electrical characteristics According to European standard IEC EN 60947-7-1	Max AC/DC Voltage	(V)	500
	Max current with rated cross-section	(A)	160
	Section	Caliber	-
Short term current allowed (I _{cw}) (value effective for 1s)	(kA)	6	6
Peak current according to EN 60947-1 (ICC)	(kA)	20	20
Rated impulse withstand voltage / degree of pollution		8kV / 3	8kV / 3
Insulation stripping length	(mm)	13	13
Tightening torque	(Nm)	2 / 2.5	2 / 2.5
Width		99	99
Thickness		131	181
Height on TH/35 7.5 mm		54	54
Height on TH/35 15 mm		61	61
Quantity for package		1	1

APPROVALS

ACCESSORIES		
Marking tag		CNU/8/51 (cod. NU0851S)
End bracket	Snap-fit TH35 and G32	BTU (cod. BT005)
	Snap-fit TH35	BTO (cod. BT007)
	Screw TH35	BT/3 (cod. BT003)

- Mounting on mounting rails PR/3 according to IEC 60715, TH/35 type or with screws on walls
- Insulation voltage 500 V (according to IEC 60947-1)
- Conformity with EU Low Voltage Directive (2014/35/UE)



GREY VERSION	CODE	QPOL1203
	TYPE	POLM.1215
BLUE VERSION	CODE	QPOL1205
	TYPE	POLM.1215/BLU
GREEN VERSION	CODE	QPOL1204
	TYPE	POLM.1215/TE

TECHNICAL CHARACTERISTICS

Function/type	phase or neutral expansion inside electrical panels
Number of pole of 1.5 mm ²	12
Number of pole of 2 mm ²	2
Number of pole of 1mm ²	1
Rated current [A]	80
Materials	polyamide CW 614N Brass

- CONTC Series terminal blocks are mainly used inside of junction boxes and, from a physical point of view, can be seen as simple Kirchhoff's nodes.
- Transparent polycarbonate, self-extinguishing UL94-V0
- High mechanical and shock resistance also at low temperatures (-25 °C)
- Resistance to flames and to ignition according to IEC 695-2-1
- 850 °C in the incandescent wire test
- High dimensional stability
- Excellent resistance to creeping currents
- High dielectric strength
- Excellent resistance to chemical and atmospheric agents
- CW 614N Brass
- Galvanised steel screws or grub screws



VERSIONS	CODE TYPE	CONT206 CONT/2/06	CONT216 CONT/2/16	CONT225 CONT/2/25	CONT235 CONT/2/35
----------	-----------	----------------------	----------------------	----------------------	----------------------

TECHNICAL CHARACTERISTICS

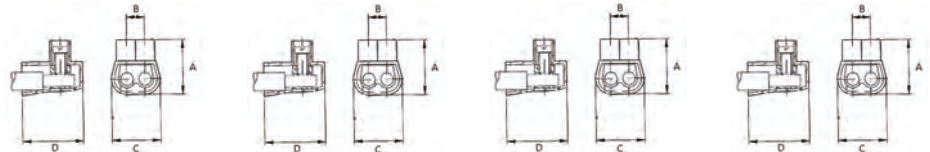

N°poles		2	2	2	2
Rated cross-section	(mm ²)	6	16	25	35
Rated Voltage	(V)	450	500	500	500
Rated current	(A)	41	76	101	125
Insulation material temperature	(°C)	130	130	130	130
Protection degree		IP20	IP20	IP20	IP20
Insulation stripping length	(mm)	6÷13	8÷16	10÷20	12÷23
A	(mm)	16	25	24.5	33
B	(mm)	6	8	10	13
C	(mm)	15	20	25	31.5
D	(mm)	18	22.5	26	31

APPROVALS



VERSIONS	CODE TYPE	CONT306 CONT/3/6	CONT316 CONT/3/16	CONT606 CONT/6/6	CONT616 CONT616
----------	-----------	---------------------	----------------------	---------------------	--------------------

TECHNICAL CHARACTERISTICS

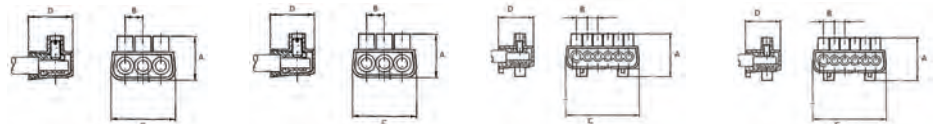

N°poles		3	3	5	1	5	1
Rated cross-section	(mm ²)	6	16	6	10	16	25
Rated Voltage	(V)	450	450	450	450	500	500
Rated current	(A)	41	76	41	41	76	76
Insulation material temperature	(°C)	130	130	130	130	130	130
Protection degree		IP20	IP20	IP20	IP20	IP20	IP20
Insulation stripping length	(mm)	8.5÷11	13÷17	13÷18	13÷18	16÷21	16÷21
A	(mm)	15.25	22	22	22	25	25
B	(mm)	5	9	7	6.5	10	9
C	(mm)	19.5	32.5	46.5	46.5	62	62
D	(mm)	14	22.25	22.5	22.5	25.25	25.25

APPROVALS



- CONTC Series terminal blocks are mainly used inside of junction boxes and, from a physical point of view, can be seen as simple Kirchhoff's nodes
- General characteristics
- High dielectric strength
- Resistance to tracking currents
- Screw-clamp
- Materials
- Products comply with the essential requirements of the BT Directive
- CW 614N Brass
- Zinc-plated screws and dowels
- Transparent polycarbonate



VERSIONS	CODE	CONTC01	CONTC02	CONTC04	CONTC06
	TYPE	CONT/1,5	CONT/2,5	CONT/4	CONT/6

TECHNICAL CHARACTERISTICS

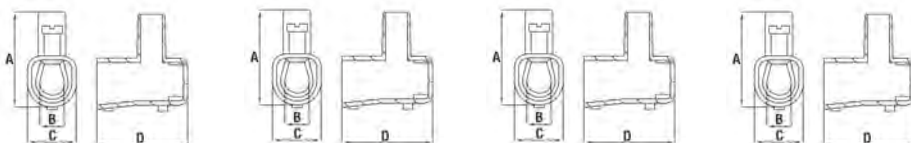

N°poles		10	10	10	10
Rated cross-section	(mm ²)	1.5	2.5	4	6
Rated Voltage	(V)	450	450	450	750
Rated current	(A)	17.5	24	32	41
Insulation material temperature	(°C)	130	130	130	130
Protection degree		IP20	IP20	IP20	IP20
A	(mm)	16	17.6	21	23
B	(mm)	3.3	3.7	4.5	5.6
C	(mm)	10	8.4	10.5	11.5
D	(mm)	15	17.6	21	22.5

APPROVALS



VERSIONS	CODE	CONTC10	CONTC16	CONTC25	CONTC35
	TYPE	CONT/10	CONT/16	CONT/25	CONT/35

TECHNICAL CHARACTERISTICS

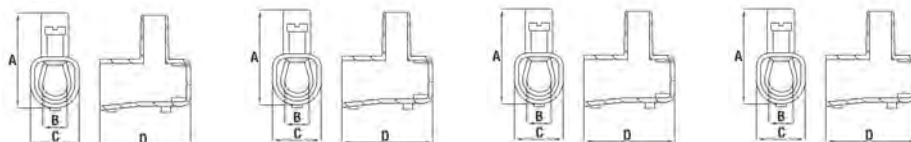

N°poles		10	10	1	1
Rated cross-section	(mm ²)	10	16	25	35
Rated Voltage	(V)	750	750	750	750
Rated current	(A)	57	76	101	125
Insulation material temperature	(°C)	130	130	130	130
Protection degree		IP20	IP20	IP20	IP20
A	(mm)	28	33	39	46
B	(mm)	6.9	9	12	14
C	(mm)	14.6	19.7	22	25
D	(mm)	26	31	38	44

APPROVALS



GENERAL CHARACTERISTICS

- Maximum withstand temperature: 80 °C
- Neutral colour

MATERIALS

- Brass
- PA6 Polyamides
- Zinc-plated steel screws



VERSIONS	CODE TYPE	CAMUT02 CAMUT.12/02	CAMUT04 CAMUT.12/04	CAMUT06 CAMUT.12/06	CAMUT10 CAMUT.12/10
----------	--------------	------------------------	------------------------	------------------------	------------------------

TECHNICAL CHARACTERISTICS

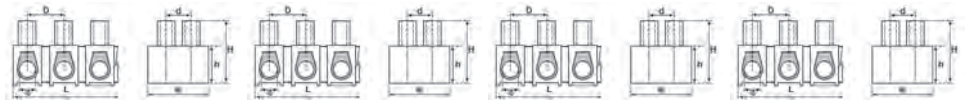

Rated current	(A)	3	5	10	15
Cross section	(mm ²)	2,5	4,0	6,0	10,0
Gauge		A3	A3	A4	A5
DIMENSIONS					
L	(mm)	93,0	117,0	132,0	141,0
W	(mm)	17,0	19,0	21,0	23,0
Ø	(mm)	2,8	3,3	4,2	4,5
D	(mm)	8,0	9,8	11,0	11,7
d	(mm)	6,0	6,5	7,8	8,5
H	(mm)	13,7	15,9	16,8	19,0
h	(mm)	8,0	9,0	10,0	10,8

VERSIONS	CODE TYPE	CAMUT16 CAMUT.12/16	CAMUT25* CAMUT.12/25	CAMUT35 CAMUT.12/35
----------	--------------	------------------------	-------------------------	------------------------

TECHNICAL CHARACTERISTICS

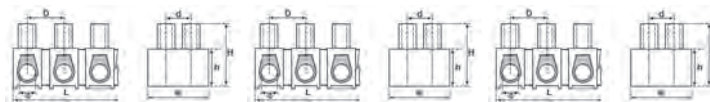

Rated current	(A)	30	60	80	
Cross section	(mm ²)	16,0	25,0	35,0	
Gauge		B6	B6	B6	
DIMENSIONS					
L	(mm)	168,0	191,0	207,0	
W	(mm)	26,0	29,7	36,5	
Ø	(mm)	5,5	6,6	7,0	
D	(mm)	14,5	16,5	18,0	
d	(mm)	9,5	11,0	14,0	
H	(mm)	20,4	25,9	30,0	
h	(mm)	12,0	15,5	19,0	

*Untill sell-out

- Maximum insulation voltage: 600V
- Nominal Current: 32A
- Conductor section range (rigid or flexible): 0,2 – 4 mm²
- Degree of protection IP20
- With voltage test point



VERSIONS	CODE TYPE	FJ402	FJ403	FJ405
----------	-----------	-------	-------	-------

TECHNICAL CHARACTERISTICS

Rated cross-section	(mm ²)	4	4	4
Connection capacity	(mm ²)	0,2 - 4	0,2 - 4	0,2 - 4
Nominal voltage	(V)	600	600	600
Nominal current	(A)	32	32	32
Number of conductors		2	3	5
Dimensions (L x W x H)	(mm)	12,4 x 20,5 x 14,5	17,0 x 20,5 x 14,5	26,6 x 20,5 x 14,5

THE FLYING SPRING CONDUCTORS

OFFERS MULTIPLE ADVANTAGES:

- Quick installation (without screwdriver)
- Possibility to connect different section cables
- Ergonomics and easy to connect
- Small size
- Secure and reliable cable clamping (spring preloaded in factory)
- Compatible with rigid and flexible cables
- Possibility to connect the cables individually, without the need to strand the conductors

Accessories

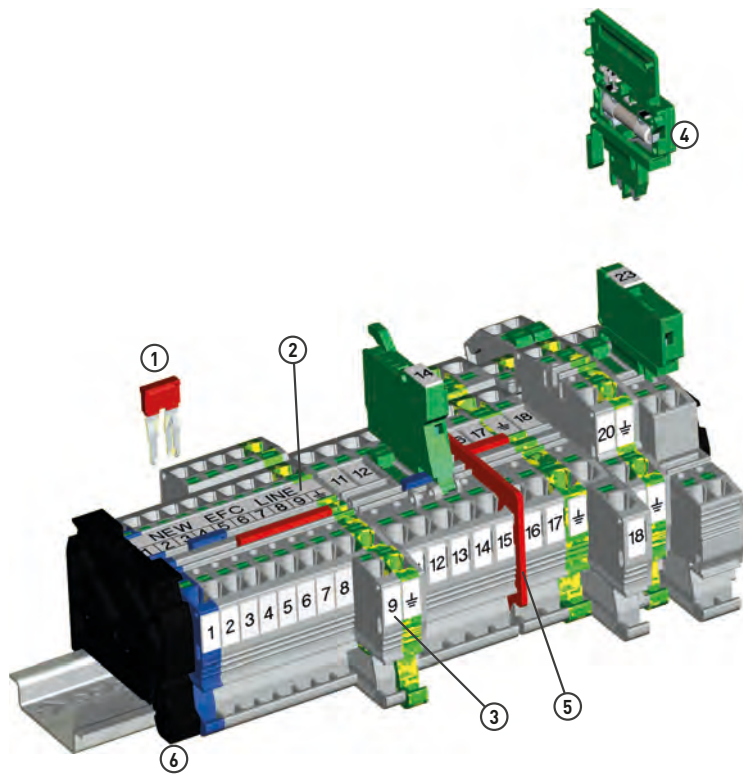

EFC SERIES

- 1 EFB Cross-connection
- 2 Adhesive numbering strip
- 3 Marking tag
- 4 CPFE component holder
- 5 DFE coloured partition
- 6 End bracket

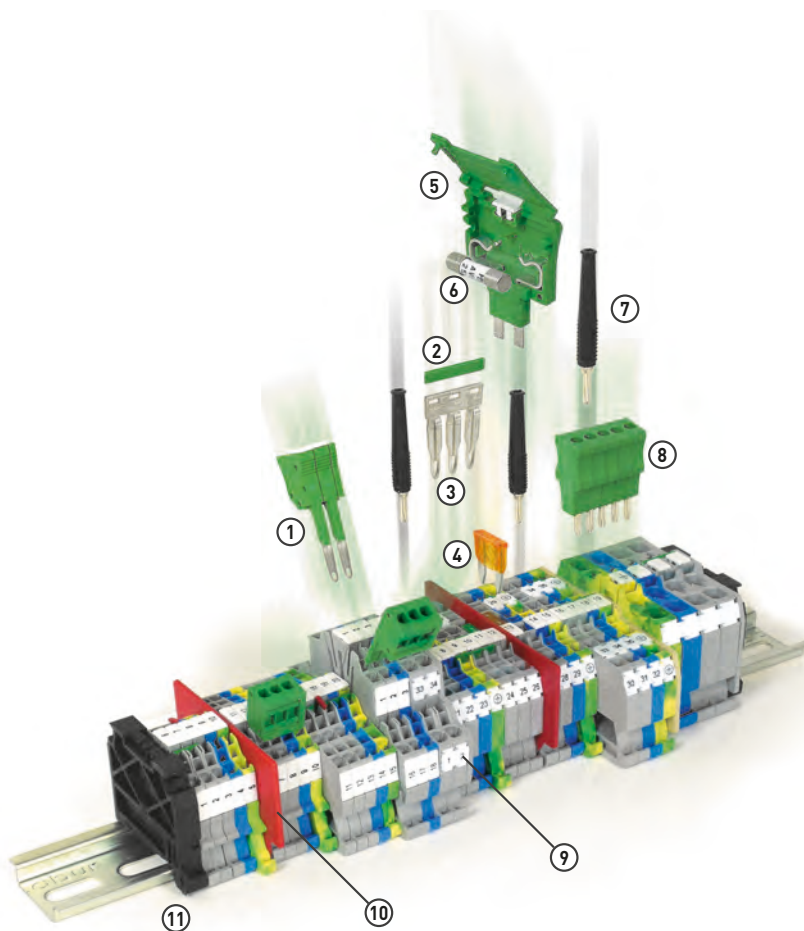

HMM SERIES

- 1 Modular test plug / connector
- 2 Cross-connection identification strip
- 3 PTC Cross-connection
- 4 Blade fuse
- 5 CPF/5 component-holder cartridge (fuse / resistor / diode)
- 6 5 X 20 mm fuse
- 7 Test plug
- 8 Modular Test plug
- 9 Marking tag
- 10 Barrier
- 11 End bracket

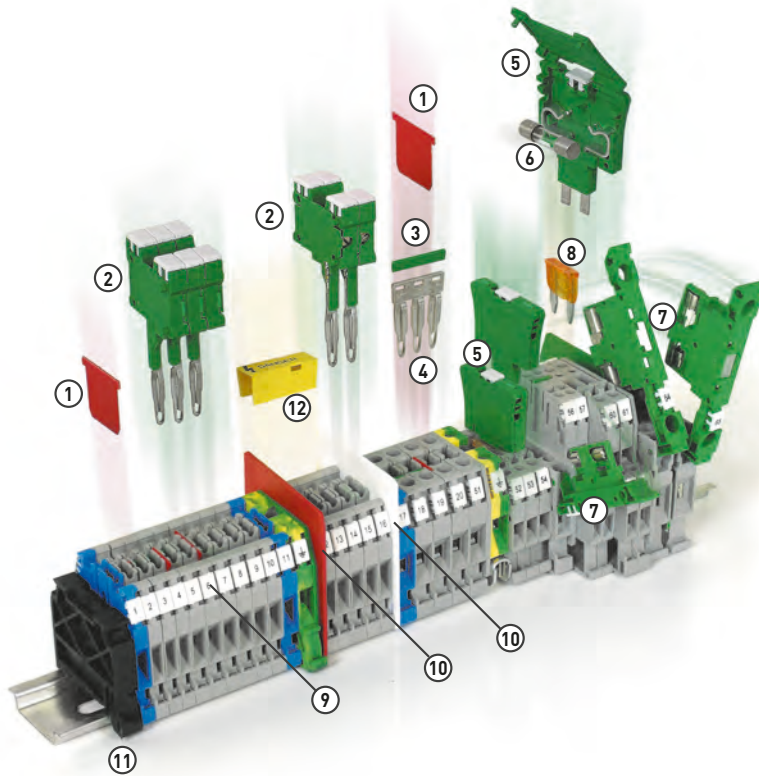

CBC SERIES

- 1 Cross-connection barrier
- 2 Modular test plug
- 3 Cross-connection identification strip
- 4 Easy Bridge cross-connection PTC
- 5 CPF/5 component-holder cartridge (fuse / resistor / diode)
- 6 5 X 20 mm fuse
- 7 Conducting element
- 8 Blade fuseTest plug
- 9 Marking tag
- 10 Coloured partition
- 11 End bracket
- 12 Warning plate

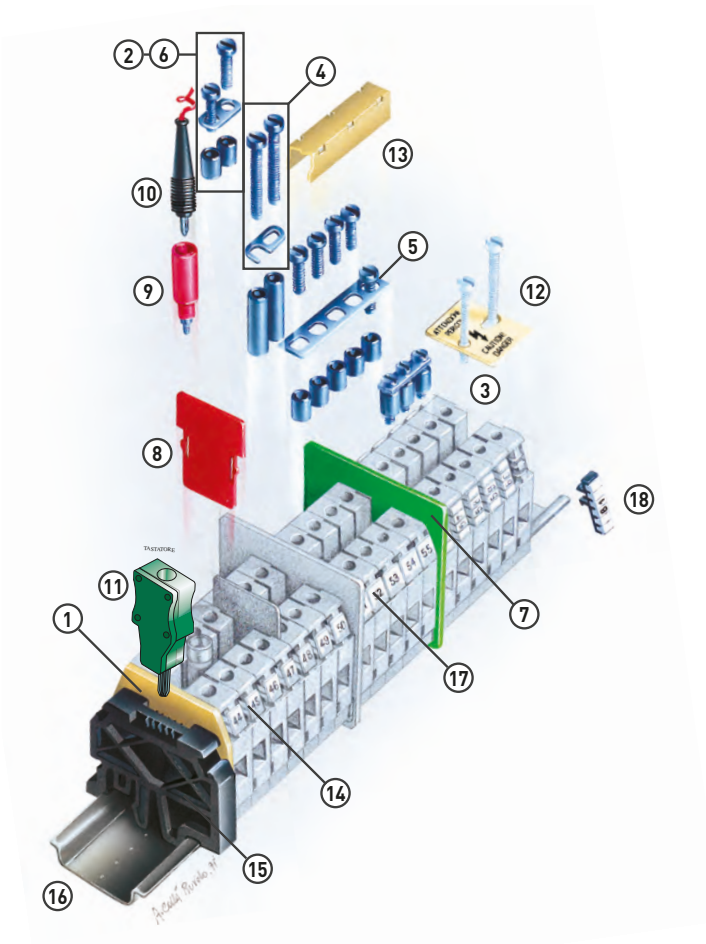

CBD SERIES

- 1 End section
- 2 Permanent cross connection
- 3 Pre-assembled cross connection
- 4 Switchable cross connection
- 5 Multiple cross connection
- 6 Shunting screw and sleeve
- 7 Coloured partition
- 8 Cross connection barrier
- 9 Test plug socket
- 10 Test plug
- 11 Modular test plug
- 12 Warning plate
- 13 Cross connection cover
- 14 Marking tag
- 15 End bracket
- 16 Mounting rail
- 17 Numbering strip
- 18 Tag adapter

For each model and section of terminal block a particular platelet for insulating and closing the open element of each terminal board is provided. This platelet can be used also to separate different phases of terminal blocks connected in parallel or to increase the insulation distances, when required by particular situations. The end platelets have the size of the related terminal block and thickness of 1.5 mm



TERMINAL BLOCK	END SECTION		TERMINAL BLOCK	END SECTION		TERMINAL BLOCK	END SECTION	
	TYPE	CODE		TYPE	CODE		TYPE	CODE
AFO.2/1+1	AFO/PT	AF201	MPS.2/SV/GR	MPS.2/PT/GR	MP121GR	EFS.2/GR	EFC.2/PT/GR	EFC201GR
AFO.2/2+2	AFO/PT	AF201	MPS.2/SW	MPS.2/PT	MP121	EFS.4/GR	EFC.4/PT/GR	EFC401GR
CBC.2/GR	CBC.2-10/PT/GR	CB061GR	MPS.2/SW/GR	MPS.2/PT/GR	MP121GR	EFT.2/GR	EFT.2/PT/GR	EFT201GR
CBC.4/GR	CBC.2-10/PT/GR	CB061GR	MPS.2/SWP	MPS.2/PT	MP121	EFT.E.2	EFT.2/PT/GR	EFT201GR
CBC.6/GR	CBC.2-10/PT/GR	CB061GR	MPS.2/SWP/	MPS.2/PT/GR	MP121GR	EFT.2/S/GR	EFT.2/S/PT/GR	EFT251GR
CBC.10/GR	CBC.2-10/PT/GR	CB061GR	MPS.4	MPS.4/PT	MP901	EFDS.2/GR	EFDS.2/PT/GR	EFDS201GR
CBC.16/GR	CBC.16/PT/GR	CB161GR	MPS.4/GR	MPS.4/PT/GR	MP901GR	EFDS.2/1S/GR	EFDS.2/PT/GR	EFDS201GR
CBC.35/GR	CBC.35/PT/GR	CB351GR	MPFA.4	MPS.4/PT	MP901	EFDS.2/P/GR	EFDS.2/PT/GR	EFDS201GR
CBD.2	CB2/PT	CB111	MPFA.4/GR	MPS.4/PT/GR	MP901GR	BLUE POLYAMIDE UL94-V0		
CBD.4	CB4/6/PT	CB241	MPS.4/SV	MPS.4/PT	MP901	CBC.2[Ex]i	CBC.2-10/PT[Ex]i	CB1061
CBD.6	CB4/6/PT	CB241	MPS.4/SV/GR	MPS.4/PT/GR	MP901GR	CBC.4[Ex]i	CBC.2-10/PT[Ex]i	CB1061
CBD.10	CB10/PT	CB431	PDF.2	PDF/PT	PF101	CBC.6[Ex]i	CBC.2-10/PT[Ex]i	CB1061
CBD.16	CB16/PT	CB511	RN.1/GR	RFN/PT/GR	RF101GR	CBC.10[Ex]i	CBC.2-10/PT[Ex]i	CB1061
CBD.35	CB35/PT	CB611	RN.2/GR	RFN/PT/GR	RF101GR	CBC.16[Ex]i	CBC.16/PT[Ex]i	CB1161
CBD.50	CB50/PT	CB711	RP.4/GR	RP.4/PT/GR	RP301GR	CBC.35[Ex]i	CBC.35/PT[Ex]i	CB1351
CBD.70	CB70/PT	CB811	SCB.4	SCB.4/PT	SB301	CBD.2 [Ex]i	CB2/PT[Ex]i	CBX13
CBE.2	CBR/PT	CR111	SCB.4/GR	SCB.4/PT/GR	SB301GR	CBD.4[Ex]i	CB4/6/PT [Ex]i	CBX25
CBR.2	CBR/PT	CR111	SCB.6	SCB.6/PT	SB201	CBD.6[Ex]i	CB4/6/PT [Ex]i	CBX25
CVF.4	CVF/PT	CV101	SCB.6/GR	SCB.6/PT/GR	SB201GR	CBD.10[Ex]i	CB10/PT [Ex]i	CBX44
CVF.4/TP	CVF/PT	CV101	SCB.6/DD	SCB.6/PT	SB201	CBD.16[Ex]i	CB16/PT [Ex]i	CBX53
CVF.4/TPM	CVF/PT	CV101	SCB.6/DD/GR	SCB.6/PT/GR	SB201GR	CBD.35[Ex]i	CB35/PT [Ex]i	CBX63
CVF.4/VS	CVF/PT	CV101	SCB.10	SCB.10/PT	SB401	CBD.50[Ex]i	CB50/PT [Ex]i	CBX73
CVF.4/VS2	CVF/PT	CV101	SCB.10/GR	SCB.10/PT/GR	SB401GR	CBD.70[Ex]i	CB70/PT [Ex]i	CBX83
CVF.4/WW	CVF/PT	CV101	SCB.10/CD	SCB.10/PT	SB401	CVF.4[Ex]i	CVF/PT [Ex]i	CV201
CVF.4/GR	CVF/PT/GR	CV101GR	SCB.10/CD/GR	SCB.10/PT/GR	SB401GR	DBC.2[Ex]i	DBC/PT[Ex]i	DB201
CVF.4/TP/GR	CVF/PT/GR	CV101GR	SCB.10/DD	SCB.10/PT	SB401	DAS.4[Ex]i	DAS/PT [Ex]i	DS201
DBC.2	DBC/PT	DB101	SCB.10/DD/GR	SCB.10/PT/GR	SB401GR	DAS.4/Ci[Ex]i	DAS/PT [Ex]i	DS201
DAS.4	DAS/PT	DS101	SCB.6/CD	SCB.6/PT	SB201	HMD.1[Ex]i	HMD.1/PT[Ex]i	HD301
DAS.4/Ci	DAS/PT	DS101	SCB.6/CD/GR	SCB.6/PT/GR	SB201GR	HMD.2N[Ex]i	HMD.1/PT[Ex]i	HD301
DAS.4/SS	DAS/PT	DS101	SFO.4	SFO/PT	SF401	HMM.1[Ex]i	HMT.1/PT [Ex]i	HI401
DSF.4/GR	DSF.4/PT/GR	DS401GR	SFO.4/GR	SFO/PT/GR	SF401GR	HMM.1/1+2[Ex]	HMT.1/1+2/PT[Ex]i	HI411
DSFA.4	DSS/PT	DS301	SFO.4/C....	SFO/PT	SF401	HMM.1/2+2[Ex]	HMT.1/2+2/PT[Ex]i	HI421
DSFA.4/GR	DSS/PT/GR	DS301GR	SFR.4	SFR/PT	SF701	HMM.2[Ex]i	HMT.2/PT [Ex]i	HI501
DSS.4	DSS/PT	DS301	SFR.4/C....	SFR/PT	SF701	HMM.2/1+2[Ex]	HMT.2/1+2/PT[Ex]i	HI511
DSS.4/GR	DSS/PT/GR	DS301GR	SFR.4/D1A	SFR/PT	SF701	HMM.2/2+2[Ex]	HMT.2/2+2/PT[Ex]i	HI521
FDP.2	FDP/PT	FD101	SFR.4/D3A	SFR/PT	SF701	HMM.4 [Ex]i	HMT.4/PT [Ex]i	HI251
FDP.2/GR	FDP/PT/GR	FD101GR	SFR.4/VS	SFR/PT	SF701	HMM.4 [Ex]i	HMT.6/PT [Ex]i	HI321
FFS.4	FFS/PT	FF101	SFR.6	SFR.6/PT	SR301	MPS.2/SW[Ex]i	MPS.2/PT[Ex]i	MP131
FFS.4/GR	FFS/PT/GR	FF101GR	TC/PO	CB2/PT	CB111	MPS.4[Ex]i	MPS.4/PT[Ex]i	MP902
FVS.4	FVS/PT	FV101	TE0.2	TE0.2/PT	TO901	RN.1 [Ex]i	RFN/PT[Ex]i	RF201
FVS.4/GR	FVS/PT/GR	FV101GR	TE0.4	TE0.4/PT	TO431	RN.2 [Ex]i	RFN/PT[Ex]i	RF201
HCD.1/GR	HCD.1/PT/GR	HC201GR	TE0.4	TE0.4/PT	TO431	RP.4[Ex]i/PT	RP.4/PT[Ex]i	RP401
HDE.2/GR	HLD.2/PT/GR	HL201GR	TDE.2	TLS/PT	TL101	SFO.4[Ex]i	SFO/PT [Ex]i	SF601
HFR.4/GR	HFR.4/PT/GR	HF211GR	TDE.2/GR	TLS/PT/GR	TL201GR	SFR.4[Ex]i	SFR/PT [Ex]i	SF801
HFR.4/M/GR	HFR.4/PT/GR	HF211GR	TLD.2	TLD/PT	TL201	SFR.6[Ex]i	SFR.6/PT[Ex]i	SR401
HLD.2/GR	HLD.2/PT/GR	HL201GR	TLD.2/GR	TLD/PT/GR	TL201GR	TC/PO[Ex]i	CB2/PT [Ex]i	CBX13
HMD.2/GR	HMD/PT/GR	HD101GR	TLS.2	TLS/PT	TL101	TLD.2[Ex]i	TLD/PT [Ex]i	TL301
HMF.4/GR	HMF/PT/GR	HF111GR	TLS.2/GR	TLS/PT/GR	TL201GR	VPC.2[Ex]i	VPC/PT [Ex]i	VP201
HSCB.4/GR	HSCB.4/PT/GR	HB101GR	TLE.2/GR	TLS/PT/GR	TL201GR	VPD.2[Ex]i	VPD/PT[Ex]i	VP561
HSCB.6/GR	HSCB.6/PT/GR	HB201GR	VPC.2	VPC/PT	VP101	EFC.2/BL	EFC.2/PT/BL	EFC201BL
HMM.2/GR	HMT.2/PT/GR	HM501GR	VPC.2/GR	VPC/PT/GR	VP101GR	EFC.2/1+2/BL	EFC.2/1+2/PT/BL	EFC211BL
HMM.2/1+2/GR	HMT.2/1+2/PT/GR	HM511GR	VPD.2/GR	VPD/PT/GR	VP501GR	EFC.2/2+2/BL	EFC.2/2+2/PT/BL	EFC221BL
HMM.2/2+2/GR	HMT.2/2+2/PT/GR	HM521GR	TR.2	TR.2/PT	TR111	EFCE.2	EFC.2/PT/BL	EFC201BL
HMM.2/2+2/S/GR	HMT.2/2+2/PT/GR	HM521GR	EFC.2/GR	EFC.2/PT/GR	EFC201GR	EFCE.2/1+2	EFC.2/1+2/PT/BL	EFC211BL
HMM.4/GR	HMT.4/PT/GR	HM251GR	EFC.2/1+2/GR	EFC.2/1+2/PT/GR	EFC211GR	EFCE.2/2+2	EFC.2/2+2/PT/BL	EFC221BL
HMM.1/GR	HMT.1/PT/GR	HM401GR	EFC.2/2+2/GR	EFC.2/2+2/PT/GR	EFC221GR	EFC.4/BL	EFC.4/PT/BL	EFC401BL
HMM.1/1+2/GR	HMT.1/1+2/PT	HM411GR	EFCE.2	EFC.2/PT/GR	EFC201GR	EFC.4/1+2/BL	EFC.4/1+2/PT/BL	EFC411BL
HMM.1/2+2/GR	HMT.1/2+2/PT	HM421GR	EFCE.2/1+2	EFC.2/1+2/PT/GR	EFC211GR	EFC.4/2+2/BL	EFC.4/2+2/PT/BL	EFC421BL
HMD.1/GR	HMD.1/PT/GR	HD201GR	EFCE.2/2+2	EFC.2/2+2/PT/GR	EFC221GR	EFCE.4	EFC.4/PT/BL	EFC401BL
HMD.2N/GR	HMD.1/PT/GR	HD201GR	EFC.4/GR	EFC.4/PT/GR	EFC401GR	EFCE.4/1+2	EFC.4/1+2/PT/BL	EFC411BL
HMM.6/GR	HMT.6/PT/GR	HM321GR	EFC.4/1+2/GR	EFC.4/1+2/PT/GR	EFC411GR	EFCE.4/2+2	EFC.4/2+2/PT/BL	EFC421BL
HMS.2/GR	HMT.2/2+2/PT/GR	HM521GR	EFC.4/2+2/GR	EFC.4/2+2/PT/GR	EFC421GR	EFD.2/BL	EFD.2/PT/BL	EFD201BL
HMFA.2/GR	HMT.2/1+2/PT/GR	HM511GR	EFCE.4	EFC.4/PT/GR	EFC401GR	EFD.2/Ci/BL	EFD.2/PT/BL	EFD201BL
HP.2/GR	HPV/PT/GR	HV111GR	EFCE.4/1+2	EFC.4/1+2/PT/GR	EFC411GR	EFD.2/E/GR	EFD.2/PT/BL	EFD201BL
HPC.2/GR	HPV/PT/GR	HV111GR	EFCE.4/2+2	EFC.4/2+2/PT/GR	EFC421GR	EFD.4/BL	EFD.4/PT/BL	EFD401BL
HPP.2/GR	HP/PT/GR	HP101GR	EFD.2/GR	EFD.2/PT/GR	EFD201GR	EFD.4/1+2/BL	EFD.4/PT/BL	EFD401BL
HTE.2	HMT.2/PT	HM501GR	EFD.2/Ci/GR	EFD.2/PT/GR	EFD201GR	EFD.4/E/GR	EFD.4/PT/BL	EFD401BL
HTE.2/1+2	HMT.2/1+2/PT	HM511GR	EFD.2/E/GR	EFD.2/PT/GR	EFD201GR	EFDE.2	EFD.2/PT/BL	EFD201BL
HTE.2/2+2	HMT.2/2+2/PT	HM521GR	EFD.4/GR	EFD.4/PT/GR	EFD401GR	EFDE.4	EFD.4/PT/BL	EFD401BL
HTE.4	HMT.4/PT/GR	HM251GR	EFD.4/Ci/GR	EFD.4/PT/GR	EFD401GR	EFF.4/BL	EFC.4/PT/BL	EFC401BL
HTE.6	HMT.6/PT/GR	HM321GR	EFD.4/E/GR	EFD.4/PT/GR	EFD401GR	EFF.4/C48/GR	EFC.4/PT/BL	EFC401BL
HTE.1	HMT.1/PT/GR	HM401GR	EFDE.2	EFD.2/PT/GR	EFD201GR	EFF.4/C230/GR	EFC.4/PT/BL	EFC401BL
HTE.1/1+2	HMT.1/1+2/PT	HM411GR	EFDE.4	EFD.4/PT/GR	EFD401GR	EFS.2/BL	EFC.2/PT/BL	EFC201BL
HTE.1/2+2	HMT.1/2+2/PT	HM421GR	EFF.4/GR	EFC.4/PT/GR	EFC401GR	EFS.4/BL	EFC.4/PT/BL	EFC401BL
HTTE.2	HLD.2/PT/GR	HL201GR	EFF.4/C48/GR	EFC.4/PT/GR	EFC401GR	EFT.2/BL	EFT.2/PT/BL	EFT201BL
MPS.2/SV	MPS.2/PT/GR	MP121	EFF.4/C230/GR	EFC.4/PT/GR	EFC401GR			

TYPE	CODE	THICKNESS	DESCRIPTION	MATERIAL	
BTU	BT005	Universal end bracket, suitable for rails conforming to both IEC 60715, "G32" type and IEC 60715/TH35 (our types PR/DIN and PR/3); it is mounted directly in the desired position and does not require screw fixing.	in black polyamide	8 mm	
BT0	BT007	End bracket suitable for IEC 60715/TH35 rails (our types PR/3); it is mounted directly in the desired position and does not require screw fixing. Particularly suitable if there are rail fixing screws with high heads.	in black polyamide	8 mm	
BT/3	BT003	To be mounted on rails in accordance with the IEC 60715/TH35 standard (our type PR/3)	in black polyamide	8 mm	
BT/2	BT006	To be mounted on rails in accordance with the IEC 60715/TH15 standard (our type PR/2).	in black polyamide	8 mm	
BT/DIN/PO	BT001	To be mounted on rails in accordance with IEC60715 type G32	in black polyamide	8 mm	

- Universal mounting for both PR/DIN and PR/3 rails which meet IEC 60715 norms, "G32" and TH/35 types
- Made of 6.6 UL94V-0 polyamide - available in grey (RAL 7042)

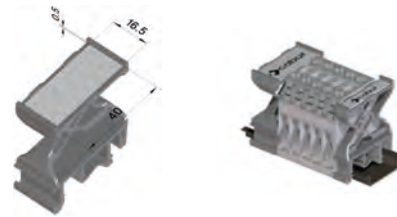

VERSION	CODE TYPE	PTM	PTM
---------	-----------	-----	-----

TECHNICAL CHARACTERISTICS

Width	43
Thickness	19.5
Height on TH/35 7.5 mm	52
Height on TH/35 15 mm	60

ACCESSORIES

Adhesive tags		TA1640AW (cod. TA1640AW) TA407AW (cod. TA407AW)
End bracket	Snap-fit TH35 and G32	BTU (cod. BT005)
	Screw G32	BT/DIN/PO (cod. BT001)
	Screw TH35	BT/3 (cod. BT003)
	Snap-fit TH35	BTO (cod. BT007)

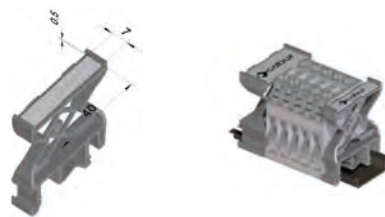
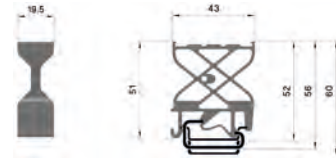

VERSION	CODE TYPE	PTMS	PTMS
---------	-----------	------	------

TECHNICAL CHARACTERISTICS

Width	43
Thickness	19.5
Height on TH/35 7.5 mm	52
Height on TH/35 15 mm	60

ACCESSORIES

Adhesive tags		TA1640AW (cod. TA1640AW) TA407AW (cod. TA407AW)
End bracket	Snap-fit TH35 and G32	BTU (cod. BT005)
	Screw G32	BT/DIN/PO (cod. BT001)
	Screw TH35	BT/3 (cod. BT003)
	Snap-fit TH35	BTO (cod. BT007)

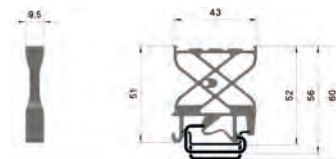

- Conforming to IEC60715/TH35 - 7.5
- Conforming to IEC60715/TH35 - 15
- Supports for TH/35 rail
- Rail supplied with 2m bars



DESCRIPTION	MATERIAL	TYPE	CODE	DIAGRAMS
Rail conforming to IEC 60715/TH35 - 7.5	in passivated steel	PR/3/AC	PR003	
Rail conforming to IEC 60715/TH35 - 7.5	in white galvanised steel "SENDZMIR" system	PR/3/AC/ZB	PR903	
Rail conforming to IEC 60715/TH35 - 7.5	in passivated steel with slots	PR/3/AS	PR005	
Rail conforming to IEC 60715/TH35 - 7.5	in white galvanised steel "SENDZMIR" system with slots	PR/3/AS/ZB	PR905	
Rail conforming to IEC 60715/TH35 - 15	in passivated steel	PR/3/PP	PR007	
Rail conforming to IEC 60715/TH35 - 15	in white galvanised steel "SENDZMIR" system	PR/3/PP/ZB	PR907	
Rail conforming to IEC 60715/TH35 - 15	in passivated steel with slots	PR/3/PA	PR006	
Rail conforming to IEC 60715/TH35 - 15	in white galvanised steel "SENDZMIR" system with slots	PR/3/PA/ZB	PR906	
Support for IEC 60715/TH35 rails	in nickel-plated steel with rapid-mounting system 4 MA	ACI121017	Z121017	
Support for IEC 60715/TH35 rails	in nickel-plated steel with rapid-mounting system 5 MA	ACI121019	Z121019	
Rail conforming to IEC 60715, "G32" type	in passivated steel	PR/DIN/AC	PR001	
Rail conforming to IEC 60715, "G32" type	in white galvanised steel "SENDZMIR" system	PR/DIN/AC/ZB	PR901	
Rail conforming to IEC 60715, "G32" type	in passivated steel with slots	PR/DIN/AS	PR004	
Rail conforming to IEC 60715, "G32" type	in white galvanised steel "SENDZMIR" system with slots	PR/DIN/AS/ZB	PR904	
Rail conforming to IEC 60715, "G32" type	in aluminium	PR/DIN/AL	PR002	
Rail conforming to IEC 60715/TH15 - 5.5	in passivated steel	PR/2/AC	PR009	
Rail conforming to IEC 60715/TH15 - 5.5	in white galvanised steel "SENDZMIR" system	PR/2/AC/ZB	PR909	
Rail conforming to IEC 60715/TH15 - 5.5	in passivated steel with slots	PR/2/AS	PR010	
Rail conforming to IEC 60715/TH15 - 5.5	in white galvanised steel "SENDZMIR" system with slots	PR/2/AS/ZB	PR910	

- Inclined bracket
- galvanised busbar holder inclined brackets suitable for fixing terminal block holder rails - M6 thread
- galvanised standard busbar holder flat brackets suitable for fixing terminal block holder rails - M6 thread



DESCRIPTION	TYPE	CODE	DIAGRAMS
Zinc-plated inclined bracket Copper 6 x 6 mm busbar holder for mounting of terminal block holder rails, with the possibility of mounting a (collecting) busbar along the entire length of the terminal block.	ACI121116	Z121116	
Zinc-plated inclined bracket Copper 6 x 6 mm busbar holder for mounting of terminal block holder rails, with the possibility of mounting a (collecting) busbar along the entire length of the terminal block.	ACI121301	Z121301	
Zinc-plated inclined bracket Standard type 2 M5 busbar holder with 2 screw fixing.	ACI121311	Z121311	
Zinc-plated inclined bracket Copper type 2 M6 busbar holder with 2 screw fixing.	ACI121314	Z121314	
Inclined bracket at 30° Standard type 6 M6 busbar holder with 1 screw fixing.	ACI121415	Z121415	
Inclined bracket at 45° Standard type 1 M6 busbar holder with 1 screw fixing.	ACI121228	Z121228	

- Inclined bracket
- galvanised busbar holder inclined brackets suitable for fixing terminal block holder rails - M6 thread
- galvanised standard busbar holder flat brackets suitable for fixing terminal block holder rails - M6 thread



DESCRIPTION	TYPE	CODE	DIAGRAMS
-------------	------	------	----------

Inclined rail holder, standard
H = 58 mm

ACI121316

Z121316

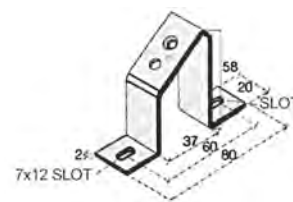

Inclined rail holder, standard
H = 68 mm

ACI121317

Z121317

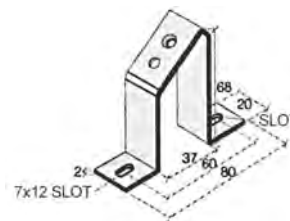

Inclined rail holder, standard
H = 78 mm

ACI121318

Z121318

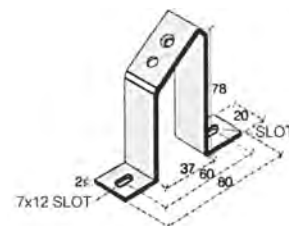

Inclined rail holder, standard
H = 88 mm

ACI121319

Z121319

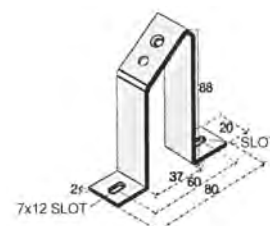

Inclined rail holder, standard
H = 98 mm

ACI121410

Z121410

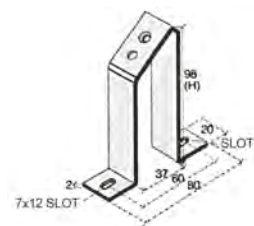

- Inclined bracket
- galvanised busbar holder inclined brackets suitable for fixing terminal block holder rails - M6 thread
- galvanised standard busbar holder flat brackets suitable for fixing terminal block holder rails - M6 thread

Fixing distance between centers, with 6MA screw, from 60 to 70 mm

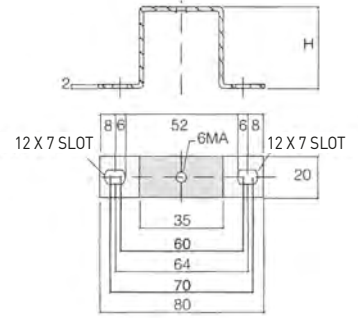

DESCRIPTION	TYPE	CODE	DIAGRAMS
Flat rail support, standard H = 20 mm	ACI121213	Z121213	
Flat rail support, standard H = 25 mm	ACI121214	Z121214	
Flat rail support, standard H = 30 mm	ACI121215	Z121215	
Flat rail support, standard H = 40 mm	ACI121216	Z121216	
Flat rail support, standard H = 50 mm	ACI121217	Z121217	
Flat rail support, standard H = 70 mm	ACI121218	Z121218	
Flat rail support, standard H = 90 mm	ACI121219	Z121219	

ACCESSORIES

- Inclined bracket
- galvanised busbar holder inclined brackets suitable for fixing terminal block holder rails - M6 thread
- galvanised standard busbar holder flat brackets suitable for fixing terminal block holder rails - M6 thread



DESCRIPTION	TYPE	CODE	DIAGRAMS
6 x 6 mm copper busbar L = 2,000 appropriate for assembly with terminal blocks electrical wire grounding	ACI121123	Z121123	
6 x 6 mm copper busbar blocking terminal with 6 MA x 12 mm screws	ACI121118	Z121118	
Terminal with saddle for 6 x 6 mm copper busbar wire section 0.5-16 mm ²	ACI121119	Z121119	
Terminal with saddle for 6 x 6 mm copper busbar wire section 4-35 mm ²	ACI121121	Z121121	
Special hexagon slot 6 MA x 12 mm screw	ACI121026	Z121026	
Special hexagon slot 5 MA x 10 mm screw	ACI121421	Z121421	
4 MA nut for rapid mounting for 32 x 9 x 15 mm steel bar	ACI121211	Z121211	
5 MA nut for rapid mounting for 32 x 9 x 15 mm steel bar	ACI121212	Z121212	
6 x 6 mm copper busbar blocking terminal with 6 MA x 25 mm screws	ACI121221	Z121221	
Inclined copper busbar support with 6 MA x 10 mm screws and 6 MA nut	ACI121307	Z121307	

- These are supplied pre-assembled for 2-3-5-10 poles
- They allow cross connection of two or more contiguous terminal blocks and are placed in an accident prevention position with respect to the outside
- all the components are made of brass with nickedl-plating surface treatment

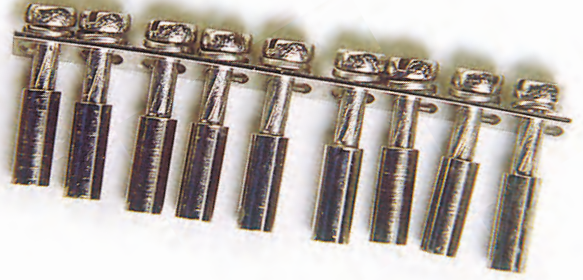

TERMINAL BLOCK	2-POLE JUMPER		3-POLE JUMPER		5-POLE JUMPER		10-POLE JUMPER	
	TYPE	CODE	TYPE	CODE	TYPE	CODE	TYPE	CODE
CBD.2	PM/20/2	PM202	PM/20/3	PM203	PM/20/5	PM205	PM/20/10	PM210
CBD.4	PM/40/2	PM402	PM/40/3	PM403	PM/40/5	PM405	PM/40/10	PM400
CBD.6	PM/60/2	PM602	PM/60/3	PM603	PM/60/5	PM605	PM/60/10	PM610
CBD.10	PM/10/2	PM102	PM/10/3	PM103	PM/10/5	PM105	PM/10/10	PM100
CBR.2	PM/25/2	PM252	PM/25/3	PM253	PM/25/5	PM255	PM/25/10	PM250
CVF.4	PM/40/2	PM402	PM/51/3	PM513	PM/51/5	PM515	PM/51/10	PM510
DAS.4	PM/41/2	PM412	PM/51/3	PM513	PM/51/5	PM515	PM/51/10	PM510
RN.1	PM/11/2	PM112	PM/11/3	PM113	PM/11/5	PM115	PM/11/10	PM110
RP.4	PM/41/2	PM412	PM/51/3	PM513	PM/51/5	PM515	PM/51/10	PM510
SCB.4	PM/41/2	PM412	PM/41/3	PM413	PM/41/5	PM415	PM/41/10	PM410
TDE.2	PM/20/2	PM202	PM/30/3	PM303	PM/30/5	PM305	PM/30/10	PM310
TLD.2	PM/20/2	PM202	PM/30/3	PM303	PM/30/5	PM305	PM/30/10	PM310
TLE.2	PM/20/2	PM202	PM/30/3	PM303	PM/30/5	PM305	PM/30/10	PM310
TLS.2	PM/20/2	PM202	PM/30/3	PM303	PM/30/5	PM305	PM/30/10	PM310
RN.2	PM/12/2	PM122	PM/12/3	PM123	PM/12/5	PM125	PM/12/10	PM120
MAC.6	PIL/2	PIL02	PIL/3	PIL03	PIL/4	PIL04	PIL/8	PIL08

- Snap coupling, with no screws
- Possibility of cross and offset-pole connection
- when inserted, intrinsically IPXXB protected installation, without the aid of further insulating protections
- System covered by patent

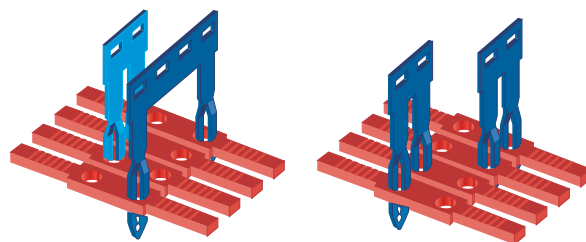

TERMINAL BLOCK	2-POLE JUMPER		3-POLE JUMPER		5-POLE JUMPER		10-POLE JUMPER		JUMPER L = 250 MM		
	TYPE	CODE	TYPE	CODE	TYPE	CODE	TYPE	CODE	TYPE	CODE	POLES
CBC.2 (1)	PTC/2/02	PTC0202	PTC/2/03	PTC0203	PTC/2/05	PTC0205	PTC/2/10	PTC0210	PTC/2/00	PTC0200	50
CBC.4 (1)	PTC/4/02	PTC0402	PTC/4/03	PTC0403	PTC/4/05	PTC0405	PTC/4/10	PTC0410	PTC/4/00	PTC0400	42
CBC.6 (1)	PTC/6/02	PTC0602	PTC/6/03	PTC0603	PTC/6/05	PTC0605	PTC/6/10	PTC0610	PTC/6/00	PTC0600	31
CBC.10 (1)	PTC/10/02	PTC1002	PTC/10/03	PTC1003	PTC/10/05	PTC1005	PTC/10/10	PTC1010	PTC/10/00	PTC1000	25
DBC.2 (1)	PTC/2/02	PTC0202	PTC/2/03	PTC0203	PTC/2/05	PTC0205	PTC/2/10	PTC0210	PTC/2/00	PTC0200	50
DSFA.4 (1)	PTC/4/02	PTC0402	PTC/4/03	PTC0403	PTC/4/05	PTC0405	PTC/4/10	PTC0410	PTC/4/00	PTC0400	42
DSS.4 (1)	PTC/4/02	PTC0402	PTC/4/03	PTC0403	PTC/4/05	PTC0405	PTC/4/10	PTC0410	PTC/4/00	PTC0400	42
HMM.1/GR (2)	PTC/1/02	PTC0102	PTC/1/03	PTC0103	PTC/1/05	PTC0105	PTC/1/10	PTC0110	PTC/1/00	PTC0100	50
HMD.1/GR	PTC/1/02	PTC0102	PTC/1/03	PTC0103	PTC/1/05	PTC0105	PTC/1/10	PTC0110	PTC/1/00	PTC0100	50
HCD.1/GR	PTC/2/02	PTC0202	PTC/2/03	PTC0203	PTC/2/05	PTC0205	PTC/2/10	PTC0210	PTC/2/00	PTC0200	50
HDE.2/GR (2)	PTC/3/02	PTC0302	PTC/3/03	PTC0303	PTC/3/05	PTC0305	PTC/3/10	PTC0310	PTC/3/00	PTC0300	47
HLD.2/GR (2)	PTC/3/02	PTC0302	PTC/3/03	PTC0303	PTC/3/05	PTC0305	PTC/3/10	PTC0310	PTC/3/00	PTC0300	47
HFR.4/GR	PTC/5/02	PTC0502	-	-	-	-	-	-	-	-	-
HFR.4/M/GR	PTC/5/02	PTC0502	PTC/5/03	PTC0503	PTC/5/05	PTC0505	PTC/5/10	PTC0510	PTC/5/00	PTC0500	40
HMM.2/GR (2)	PTC/3/02	PTC0302	PTC/3/03	PTC0303	PTC/3/05	PTC0305	PTC/3/10	PTC0310	PTC/3/00	PTC0300	47
HMS.2/GR	PTC/3/02	PTC0302	PTC/3/03	PTC0303	PTC/3/05	PTC0305	PTC/3/10	PTC0310	PTC/3/00	PTC0300	47
HMFA.2/GR	PTC/3/02	PTC0302	PTC/3/03	PTC0303	PTC/3/05	PTC0305	PTC/3/10	PTC0310	PTC/3/00	PTC0300	47
HMM.4/GR (2)	PTC/5/02	PTC0502	PTC/5/03	PTC0503	PTC/5/05	PTC0505	PTC/5/10	PTC0510	PTC/5/00	PTC0500	40
HMFA.2/GR	PTC/3/02	PTC0302	PTC/3/03	PTC0303	PTC/3/05	PTC0305	PTC/3/10	PTC0310	PTC/3/00	PTC0300	47
HSCB.4/GR	PTC/5/02	PTC0502	PTC/5/03	PTC0503	PTC/5/05	PTC0505	PTC/5/10	PTC0510	PTC/5/00	PTC0500	40
HSCB.6/GR	PTC/8/02	PTC0802	PTC/8/03	PTC0803	PTC/8/05	PTC0805	PTC/8/10	PTC0810	PTC/8/00	PTC0800	30
HMM.6/GR	PTC/8/02	PTC0802	PTC/8/03	PTC0803	PTC/8/05	PTC0805	PTC/8/10	PTC0810	PTC/8/00	PTC0800	30
HMM.10/GR	PTC/11/02	PTC1102	PTC/11/03	PTC1103	PTC/11/05	PTC1105	PTC/11/10	PTC1110	PTC/11/00	PTC1100	25
HMM.16/GR	PTC/16/02	PTC1602	PTC/16/03	PTC1603	PTC/16/05	PTC1605	PTC/16/10	PTC1610	PTC/16/00	PTC1600	20
HVPC.2/GR	PTC/3/02	PTC0302	PTC/3/03	PTC0303	PTC/3/05	PTC0305	PTC/3/10	PTC0310	PTC/3/00	PTC0300	47
CHP.2/GR	PTC/3/02	PTC0302	PTC/3/03	PTC0303	PTC/3/05	PTC0305	PTC/3/10	PTC0310	PTC/3/00	PTC0300	47
CHP.2D/GR	PTC/3/02	PTC0302	PTC/3/03	PTC0303	PTC/3/05	PTC0305	PTC/3/10	PTC0310	PTC/3/00	PTC0300	47
HPP.2/GR	PTC/3/02	PTC0302	PTC/3/03	PTC0303	PTC/3/05	PTC0305	PTC/3/10	PTC0310	PTC/3/00	PTC0300	47
HP.2/GR	PTC/3/02	PTC0302	PTC/3/03	PTC0303	PTC/3/05	PTC0305	PTC/3/10	PTC0310	PTC/3/00	PTC0300	47
HPC.2/GR	PTC/3/02	PTC0302	PTC/3/03	PTC0303	PTC/3/05	PTC0305	PTC/3/10	PTC0310	PTC/3/00	PTC0300	47
MPS.4 (1)	PTC/4/02	PTC0402	PTC/4/03	PTC0403	PTC/4/05	PTC0405	PTC/4/10	PTC0410	PTC/4/00	PTC0400	42
MPFA.4 (1)	PTC/4/02	PTC0402	PTC/4/03	PTC0403	PTC/4/05	PTC0405	PTC/4/10	PTC0410	PTC/4/00	PTC0400	42
SFR.6 (1)	PTC/20/02	PTC2002	PTC/20/03	PTC2003	PTC/20/05	PTC2005	PTC/20/10	PTC2010	PTC/20/00	PTC2000	25
VPC.2 (1)	PTC/2/02	PTC0202	PTC/2/03	PTC0203	PTC/2/05	PTC0205	PTC/2/10	PTC0210	PTC/2/00	PTC0200	50
VPD.2 (1)	PTC/2/02	PTC0202	PTC/2/03	PTC0203	PTC/2/05	PTC0205	PTC/2/10	PTC0210	PTC/2/00	PTC0200	50



After cutting the bar for the number of poles necessary, insert the cross connection in the special cavity of the terminal block.

At this point working with the tip of a screwdriver, push the cross connection up to the locking point. The cross connection will be completely isolated and intrinsically IPXXB protected.



After inserting the cross connection, the poles connected can be highlighted with the aid of the green insert, PTC/SP. This accessory is supplied in the standard length of 100 mm and can easily be sliced with the aid of a simple cutter.



To remove the cross connection it is sufficient to remove the PTC/SP insert, insert the tip of the screwdriver in the slot of the cross connection itself, lever it and pull it out.

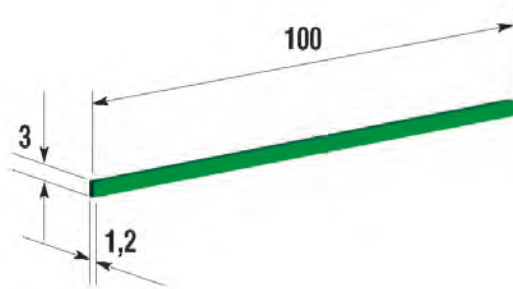

In panels with little light, seeing clearly where the cross connections are inserted is not always immediate and easy if particular attention is not paid; this can cause connection errors.

It is precisely to solve this problem that Cabur has created a marker to be used on its terminal blocks that adopt PTC cross connections, in order to make locating them easier, after insertion.

A single model was created (PTC/SP - Cat. No. PTC0990)

common to all terminal blocks, irrespective of the pitch or the model of the PTC cross connection used. The marker must be housed in the cross-connection seat; stability on the terminal block is guaranteed by the friction on the walls of the cross-connection insertion grooves.

Note:

application of the PTC/SP marker is possible on all terminal blocks that adopt PTC cross connections (as in the list) with the exception of the HCD.1 and HMD.2N terminal blocks: in these two terminal blocks the shape of the cross-connection seat makes it impossible to obtain the friction necessary to guarantee stably the positioning and permanence. In the same way the cross connections of these two terminal blocks have a less deep introduction compared to all the others and therefore the presence of the cross connection can be seen without the need for the marker.

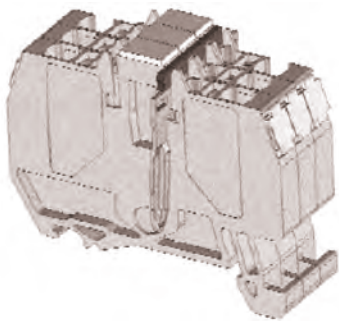

Examples of application on the HMM.2 terminal block.

The dimensions of the marker have been studied so as not to protrude from the profile of any of the terminal blocks on which it can be applied, so as not to interfere with numbering, cables or other accessories.



The marker can be applied also in the case of double cross connections. It is to be noted that the marker can be applied in the presence of other accessories, without having to be extracted in advance.

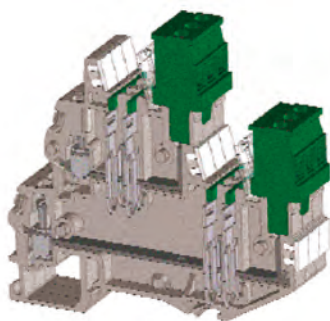

Examples of application on the VPD.2 terminal block.

The marker is produced in sticks of a length of 100 mm each and is supplied in green. Users can autonomously reduce its length according to their needs.

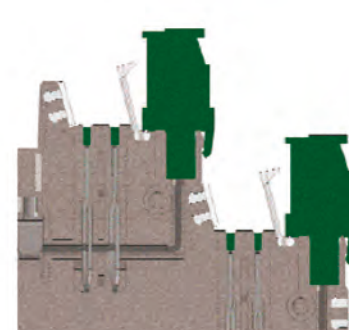

The cutting operation is possible with no difficulty using a common pair of pliers, because the thickness of the sticks, made of polyamide, is only 1.20 mm.

- Snap coupling, with no screws
- Possibility of cross and offset-pole connection
- when inserted, intrinsically IPXXB protected installation, without the aid of further insulating protections
- Colours red or blue for immediate visibility of the cross connection and identification of polarity or phase
- Upper surface markable with indelible marker pen



TERMINAL BLOCK	JUMPER COLOUR	2-POLE JUMPER		3-POLE JUMPER		5-POLE JUMPER		10-POLE JUMPER		30-POLE JUMPER	
		TYPE	CODE	TYPE	CODE	TYPE	CODE	TYPE	CODE	TYPE	CODE
CBC.2/GR	RED	PTP/2/02/R	PTP0202R	PTP/2/03/R	PTP0203R	PTP/2/05/R	PTP0205R	PTP/2/10/R	PTP0210R	PTP/2/30/R	PTP0230R
	BLUE	PTP/2/02/B	PTP0202B	PTP/2/03/B	PTP0203B	PTP/2/05/B	PTP0205B	PTP/2/10/B	PTP0210B	PTP/2/30/B	PTP0230B
CBC.4/GR	RED	PTP/4/02/R	PTP0402R	PTP/4/03/R	PTP0403R	PTP/4/05/R	PTP0405R	PTP/4/10/R	PTP0410R	PTP/4/30/R	PTP0430R
	BLUE	PTP/4/02/B	PTP0402B	PTP/4/03/B	PTP0403B	PTP/4/05/B	PTP0405B	PTP/4/10/B	PTP0410B	PTP/4/30/B	PTP0430B
CBS.2 and CBS.2/GR	RED	PTP/2/02/R	PTP0202R	PTP/2/03/R	PTP0203R	PTP/2/05/R	PTP0205R	PTP/2/10/R	PTP0210R	PTP/2/30/R	PTP0230R
	BLUE	PTP/2/02/B	PTP0202B	PTP/2/03/B	PTP0203B	PTP/2/05/B	PTP0205B	PTP/2/10/B	PTP0210B	PTP/2/30/B	PTP0230B
CBS.4 and CBS.4/GR	RED	PTP/4/02/R	PTP0402R	PTP/4/03/R	PTP0403R	PTP/4/05/R	PTP0405R	PTP/4/10/R	PTP0410R	PTP/4/30/R	PTP0430R
	BLUE	PTP/4/02/B	PTP0402B	PTP/4/03/B	PTP0403B	PTP/4/05/B	PTP0405B	PTP/4/10/B	PTP0410B	PTP/4/30/B	PTP0430B
CBF.4/GR	RED	PTP/4/02/R	PTP0402R	PTP/4/03/R	PTP0403R	PTP/4/05/R	PTP0405R	PTP/4/10/R	PTP0410R	PTP/4/30/R	PTP0430R
	BLUE	PTP/4/02/B	PTP0402B	PTP/4/03/B	PTP0403B	PTP/4/05/B	PTP0405B	PTP/4/10/B	PTP0410B	PTP/4/30/B	PTP0430B
HMM.2/GR (1)	RED	PTP/3/02/R	PTP0302R	PTP/3/03/R	PTP0303R	PTP/3/05/R	PTP0305R	PTP/3/10/R	PTP0310R	PTP/3/30/R	PTP0330R
	BLUE	PTP/3/02/B	PTP0302B	PTP/3/03/B	PTP0303B	PTP/3/05/B	PTP0305B	PTP/3/10/B	PTP0310B	PTP/3/30/B	PTP0330B
HMM.4/GR (1)	RED	PTP/5/02/R	PTP0502R	PTP/5/03/R	PTP0503R	PTP/5/05/R	PTP0505R	PTP/5/10/R	PTP0510R	PTP/5/30/R	PTP0530R
	BLUE	PTP/5/02/B	PTP0502B	PTP/5/03/B	PTP0503B	PTP/5/05/B	PTP0505B	PTP/5/10/B	PTP0510B	PTP/5/30/B	PTP0530B
HMD.2N/GR	RED	PTP/3/02/R	PTP0302R	PTP/3/03/R	PTP0303R	PTP/3/05/R	PTP0305R	PTP/3/10/R	PTP0310R	PTP/3/30/R	PTP0330R
	BLUE	PTP/3/02/B	PTP0302B	PTP/3/03/B	PTP0303B	PTP/3/05/B	PTP0305B	PTP/3/10/B	PTP0310B	PTP/3/30/B	PTP0330B
HLD.2/GR (1)	RED	PTP/3/02/R	PTP0302R	PTP/3/03/R	PTP0303R	PTP/3/05/R	PTP0305R	PTP/3/10/R	PTP0310R	PTP/3/30/R	PTP0330R
	BLUE	PTP/3/02/B	PTP0302B	PTP/3/03/B	PTP0303B	PTP/3/05/B	PTP0305B	PTP/3/10/B	PTP0310B	PTP/3/30/B	PTP0330B
HDE.2/GR (1)	RED	PTP/3/02/R	PTP0302R	PTP/3/03/R	PTP0303R	PTP/3/05/R	PTP0305R	PTP/3/10/R	PTP0310R	PTP/3/30/R	PTP0330R
	BLUE	PTP/3/02/B	PTP0302B	PTP/3/03/B	PTP0303B	PTP/3/05/B	PTP0305B	PTP/3/10/B	PTP0310B	PTP/3/30/B	PTP0330B
CHP.2/GR (1)	RED	PTP/3/02/R	PTP0302R	PTP/3/03/R	PTP0303R	PTP/3/05/R	PTP0305R	PTP/3/10/R	PTP0310R	PTP/3/30/R	PTP0330R
	BLUE	PTP/3/02/B	PTP0302B	PTP/3/03/B	PTP0303B	PTP/3/05/B	PTP0305B	PTP/3/10/B	PTP0310B	PTP/3/30/B	PTP0330B
CHP.2D/GR (1)	RED	PTP/3/02/R	PTP0302R	PTP/3/03/R	PTP0303R	PTP/3/05/R	PTP0305R	PTP/3/10/R	PTP0310R	PTP/3/30/R	PTP0330R
	BLUE	PTP/3/02/B	PTP0302B	PTP/3/03/B	PTP0303B	PTP/3/05/B	PTP0305B	PTP/3/10/B	PTP0310B	PTP/3/30/B	PTP0330B
HVPC.2/GR(1)	RED	PTP/3/02/R	PTP0302R	PTP/3/03/R	PTP0303R	PTP/3/05/R	PTP0305R	PTP/3/10/R	PTP0310R	PTP/3/30/R	PTP0330R
	BLUE	PTP/3/02/B	PTP0302B	PTP/3/03/B	PTP0303B	PTP/3/05/B	PTP0305B	PTP/3/10/B	PTP0310B	PTP/3/30/B	PTP0330B
HMS.2/GR	RED	PTP/3/02/R	PTP0302R	PTP/3/03/R	PTP0303R	PTP/3/05/R	PTP0305R	PTP/3/10/R	PTP0310R	PTP/3/30/R	PTP0330R
	BLUE	PTP/3/02/B	PTP0302B	PTP/3/03/B	PTP0303B	PTP/3/05/B	PTP0305B	PTP/3/10/B	PTP0310B	PTP/3/30/B	PTP0330B
HMFA.2/GR	RED	PTP/3/02/R	PTP0302R	PTP/3/03/R	PTP0303R	PTP/3/05/R	PTP0305R	PTP/3/10/R	PTP0310R	PTP/3/30/R	PTP0330R
	BLUE	PTP/3/02/B	PTP0302B	PTP/3/03/B	PTP0303B	PTP/3/05/B	PTP0305B	PTP/3/10/B	PTP0310B	PTP/3/30/B	PTP0330B
HSCB.4/GR	RED	PTP/3/02/R	PTP0302R	PTP/3/03/R	PTP0303R	PTP/3/05/R	PTP0305R	PTP/3/10/R	PTP0310R	PTP/3/30/R	PTP0330R
	BLUE	PTP/3/02/B	PTP0302B	PTP/3/03/B	PTP0303B	PTP/3/05/B	PTP0305B	PTP/3/10/B	PTP0310B	PTP/3/30/B	PTP0330B
HFR.4/M/GR	RED	PTP/3/02/R	PTP0302R	PTP/3/03/R	PTP0303R	PTP/3/05/R	PTP0305R	PTP/3/10/R	PTP0310R	PTP/3/30/R	PTP0330R
	BLUE	PTP/3/02/B	PTP0302B	PTP/3/03/B	PTP0303B	PTP/3/05/B	PTP0305B	PTP/3/10/B	PTP0310B	PTP/3/30/B	PTP0330B
MPS.4	RED	PTP/4/02/R	PTP0402R	PTP/4/03/R	PTP0403R	PTP/4/05/R	PTP0405R	PTP/4/10/R	PTP0410R	PTP/4/30/R	PTP0430R
	BLUE	PTP/4/02/B	PTP0402B	PTP/4/03/B	PTP0403B	PTP/4/05/B	PTP0405B	PTP/4/10/B	PTP0410B	PTP/4/30/B	PTP0430B
MPFA.4	RED	PTP/4/02/R	PTP0402R	PTP/4/03/R	PTP0403R	PTP/4/05/R	PTP0405R	PTP/4/10/R	PTP0410R	PTP/4/30/R	PTP0430R
	BLUE	PTP/4/02/B	PTP0402B	PTP/4/03/B	PTP0403B	PTP/4/05/B	PTP0405B	PTP/4/10/B	PTP0410B	PTP/4/30/B	PTP0430B
DSS.4	RED	PTP/4/02/R	PTP0402R	PTP/4/03/R	PTP0403R	PTP/4/05/R	PTP0405R	PTP/4/10/R	PTP0410R	PTP/4/30/R	PTP0430R
	BLUE	PTP/4/02/B	PTP0402B	PTP/4/03/B	PTP0403B	PTP/4/05/B	PTP0405B	PTP/4/10/B	PTP0410B	PTP/4/30/B	PTP0430B
DSFA.4	RED	PTP/4/02/R	PTP0402R	PTP/4/03/R	PTP0403R	PTP/4/05/R	PTP0405R	PTP/4/10/R	PTP0410R	PTP/4/30/R	PTP0430R
	BLUE	PTP/4/02/B	PTP0402B	PTP/4/03/B	PTP0403B	PTP/4/05/B	PTP0405B	PTP/4/10/B	PTP0410B	PTP/4/30/B	PTP0430B
HCD.1	RED	PTP/2/02/R	PTP0202R	PTP/2/03/R	PTP0203R	PTP/2/05/R	PTP0205R	PTP/2/10/R	PTP0210R	PTP/2/30/R	PTP0230R
	BLUE	PTP/2/02/B	PTP0202B	PTP/2/03/B	PTP0203B	PTP/2/05/B	PTP0205B	PTP/2/10/B	PTP0210B	PTP/2/30/B	PTP0230B

(1) Including the versions /1+2, /2+2 and/or the corresponding earth terminal blocks, if available.



After cutting the bar for the number of poles necessary, insert the cross connection in the special seat in the terminal block. With the tip of the screwdriver push the cross-connection until it comes to a stop. The cross connection will be completely insulated, intrinsically IPXXB protected and visible.

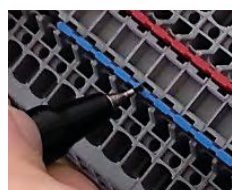

The upper surface can be marked with an indelible marker pen to indicate the presence of the pole and of the electrical connection with the underlying terminal block in cross connections with alternating poles



To remove the cross connection it is sufficient to insert the tip of the screwdriver in the slot of the cross connection itself and lever it to pull it out; with cross connections of more than 5 poles lever gradually at the centre and at the two ends until it is completely extracted

To guarantee the correct safety conditions, after insertion and depending on the multiple connection schemes obtainable using the PTC/PTP cross connections, the table below is provided:

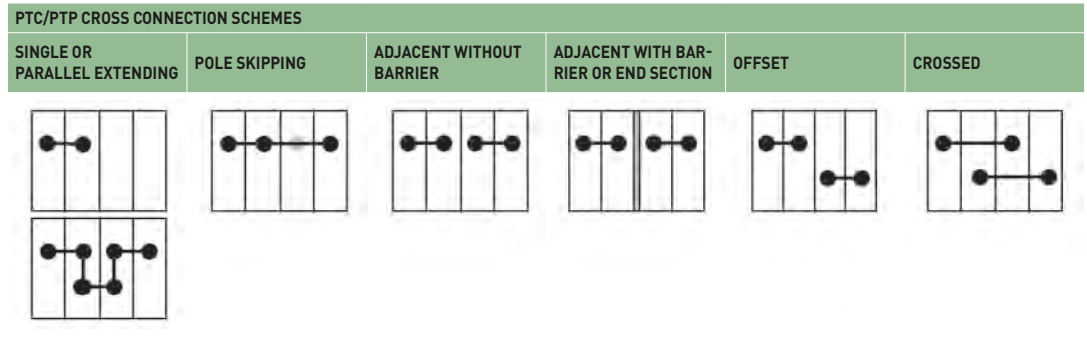

TERMINAL BLOCK	JUMPER TYPE	ISOLATION VOLTAGE IN THE ABOVE CONFIGURATIONS (V)					
		SINGLE OR PARALLEL EXTENDING	POLE SKIPPING	ADJACENT WITHOUT BARRIER	ADJACENT WITH BARRIER OR END SECTION	OFFSET	CROSSED
CBC.2	PTC/2 PTP/2	630	630	-	500	500	500
CBC.4	PTC/4 PTP/4	630	500	-	500	500	500
CBC.6	PTC/6	630	630	-	630	630	500
CBC.10	PTC/10	800	630	-	630	800	500
VPC.2	PTC/2	320	320	-	320	320	320
HMFA.2 - HMS.2	PTC/3	630	500	-	500 (1)	-	-
HMM.1 Series	PTC/1	630	630	-	320	630	630
HMM.2 Series	PTC/3 PTP/3	630	500	-	500 (1)	630	630
HMM.4 Series	PTC/5 PTP/5	500	500	-	500 (1)	500	500
HMM.10	PTC/11	1000	1000	-	800	1000	1000
HMM.16	PTC/16	1000	1000	-	800	1000	800
DBC.2	PTC/2	630	500	-	250 (2)	500	500
DBC.2	PTC/2	630	500	-	630 (3)	500	500
HCD.1	PTC/2	320	320	-	320	320	320
HVPC.2/GR	PTC/3	500	500	-	500 (1)	500	500
CHP.2/GR - CHP.2D/GR	PTC/11	500 (630)	500	-	400 (1)	-	-
HPP.2/GR - HP.2/GR	PTC/3	400	400	-	800 (1)	500	400
HPC.2/GR	PTC/3	400	400	-	800 (1)	400	400
SFR.6	PTC/20	630	630	400	630	630	500
MPS.4-MPFA.4	PTC/4	400	400	-	400	-	-
DSS.4-DSFA.4	PTC/4	400	400	-	400	-	-
HMD.1	PTC/1	500	500	-	320	500	500
VPD.2	PTC/2	320	320	-	320	320	320
HSCB.4	PTC/5	500	500	-	500 (1)	500	500
HSCB.6	PTC/8	500	500	-	400	500	500

(1) with interposition of end platelet

(2) between lower adjacent cross connections (with barrier)

(3) between upper adjacent cross connections (with barrier)



ACCESSORIES

- For HMD.2 and FDP.2 terminal blocks

TERMINAL BLOCK	JUMPER TYPE	CODE
HMD.2	PH/2.5-4	PH100
FDP.2	PH/2.5-4	PH100

[1] to complete the insertion of the jumpers, the use of screwdriver is necessary

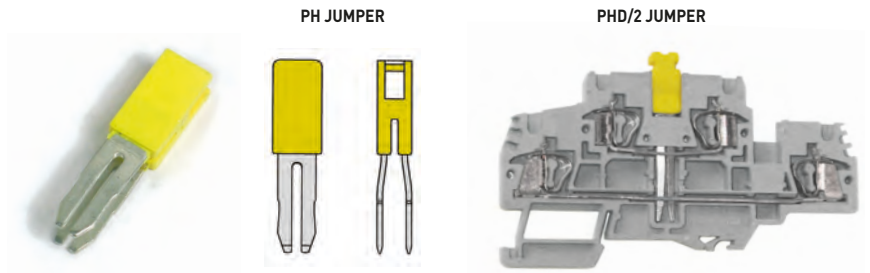

HMD.2/6R CAT. NO. HD100GR

FOR MINI SPRING-CLAMP TERMINAL BLOCKS

TERMINAL BLOCK	2-POLE JUMPER		3-POLE JUMPER		5-POLE JUMPER	
	TYPE	CODE	TYPE	CODE	TYPE	CODE
HP.2/P	PTC/2/02	PTC0202	PTC/2/03	PTC0203	PTC/2/05	PTC0205
HPC.2/P	PTC/2/02	PTC0202	PTC/2/03	PTC0203	PTC/2/05	PTC0205
HPP.2/P	PTC/2/02	PTC0202	PTC/2/03	PTC0203	PTC/2/05	PTC0205

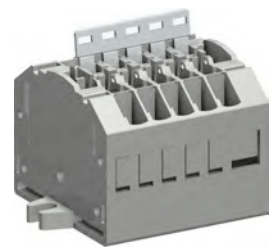

FOR EFC TERMINAL BLOCKS

TERMINAL BLOCK	COLOUR	2-POLE JUMPER		3-POLE JUMPER		5-POLE JUMPER		10-POLE JUMPER	
		TYPE	CODE	TYPE	CODE	TYPE	CODE	TYPE	CODE
EFC.2 SERIES	Red	EFB.2/2/R	EFB0202R	EFB.2/3/R	EFB0203R	EFB.2/5/R	EFB0205R	EFB.2/10/R	EFB0210R
	Blue	EFB.2/2/B	EFB0202B	EFB.2/3/B	EFB0203B	EFB.2/5/B	EFB0205B	EFB.2/10/B	EFB0210B
EFCE.2 SERIES	Red	EFB.2/2/R	EFB0202R	EFB.2/3/R	EFB0203R	EFB.2/5/R	EFB0205R	EFB.2/10/R	EFB0210R
	Blue	EFB.2/2/B	EFB0202B	EFB.2/3/B	EFB0203B	EFB.2/5/B	EFB0205B	EFB.2/10/B	EFB0210B
EFC.4 SERIES	Red	EFB.4/2/R	EFB0402R	EFB.4/3/R	EFB0403R	EFB.4/5/R	EFB0405R	EFB.4/10/R	EFB0410R
	Blue	EFB.4/2/B	EFB0402B	EFB.4/3/B	EFB0403B	EFB.4/5/B	EFB0405B	EFB.4/10/B	EFB0410B
EFCE.4 SERIES	Red	EFB.4/2/R	EFB0402R	EFB.4/3/R	EFB0403R	EFB.4/5/R	EFB0405R	EFB.4/10/R	EFB0410R
	Blue	EFB.4/2/B	EFB0402B	EFB.4/3/B	EFB0403B	EFB.4/5/B	EFB0405B	EFB.4/10/B	EFB0410B
EFD.2 SERIES	Red	EFB.2/2/R	EFB0202R	EFB.2/3/R	EFB0203R	EFB.2/5/R	EFB0205R	EFB.2/10/R	EFB0210R
	Blue	EFB.2/2/B	EFB0202B	EFB.2/3/B	EFB0203B	EFB.2/5/B	EFB0205B	EFB.2/10/B	EFB0210B
EFD.4 SERIES	Red	EFB.4/2/R	EFB0402R	EFB.4/3/R	EFB0403R	EFB.4/5/R	EFB0405R	EFB.4/10/R	EFB0410R
	Blue	EFB.4/2/B	EFB0402B	EFB.4/3/B	EFB0403B	EFB.4/5/B	EFB0405B	EFB.4/10/B	EFB0410B
EFD.2 SERIES	Red	EFB.2/2/R	EFB0202R	EFB.2/3/R	EFB0203R	EFB.2/5/R	EFB0205R	EFB.2/10/R	EFB0210R
	Blue	EFB.2/2/B	EFB0202B	EFB.2/3/B	EFB0203B	EFB.2/5/B	EFB0205B	EFB.2/10/B	EFB0210B
EFD.4 SERIES	Red	EFB.4/2/R	EFB0402R	EFB.4/3/R	EFB0403R	EFB.4/5/R	EFB0405R	EFB.4/10/R	EFB0410R
	Blue	EFB.4/2/B	EFB0402B	EFB.4/3/B	EFB0403B	EFB.4/5/B	EFB0405B	EFB.4/10/B	EFB0410B
EFD.2 SERIES	Red	EFB.2/2/R	EFB0202R	EFB.2/3/R	EFB0203R	EFB.2/5/R	EFB0205R	EFB.2/10/R	EFB0210R
	Blue	EFB.2/2/B	EFB0202B	EFB.2/3/B	EFB0203B	EFB.2/5/B	EFB0205B	EFB.2/10/B	EFB0210B
EFD.4 SERIES	Red	EFB.4/2/R	EFB0402R	EFB.4/3/R	EFB0403R	EFB.4/5/R	EFB0405R	EFB.4/10/R	EFB0410R
	Blue	EFB.4/2/B	EFB0402B	EFB.4/3/B	EFB0403B	EFB.4/5/B	EFB0405B	EFB.4/10/B	EFB0410B
EFD.2 SERIES	Red	EFB.2/2/R	EFB0202R	EFB.2/3/R	EFB0203R	EFB.2/5/R	EFB0205R	EFB.2/10/R	EFB0210R
	Blue	EFB.2/2/B	EFB0202B	EFB.2/3/B	EFB0203B	EFB.2/5/B	EFB0205B	EFB.2/10/B	EFB0210B
EFD.4 SERIES	Red	EFB.4/2/R	EFB0402R	EFB.4/3/R	EFB0403R	EFB.4/5/R	EFB0405R	EFB.4/10/R	EFB0410R
	Blue	EFB.4/2/B	EFB0402B	EFB.4/3/B	EFB0403B	EFB.4/5/B	EFB0405B	EFB.4/10/B	EFB0410B
EFD.2 SERIES	Red	EFB.2/2/R	EFB0202R	EFB.2/3/R	EFB0203R	EFB.2/5/R	EFB0205R	EFB.2/10/R	EFB0210R
	Blue	EFB.2/2/B	EFB0202B	EFB.2/3/B	EFB0203B	EFB.2/5/B	EFB0205B	EFB.2/10/B	EFB0210B
EFD.4 SERIES	Red	EFB.4/2/R	EFB0402R	EFB.4/3/R	EFB0403R	EFB.4/5/R	EFB0405R	EFB.4/10/R	EFB0410R
	Blue	EFB.4/2/B	EFB0402B	EFB.4/3/B	EFB0403B	EFB.4/5/B	EFB0405B	EFB.4/10/B	EFB0410B



They enable cross connection of two adjacent terminal blocks and are placed in an accident prevention position with respect to the outside.

The POF is made up of:

- 2 screws
- 2 sleeves
- 1 plate with 2 holes

All the components are in brass, with nickel plating.



TERMINAL BLOCK	JUMPER TYPE	CODE	SCREW M X L (MM)	SLEEVE Ø X L (MM)	PLATE L X S (MM)
CBC.16	POF/53	POF53	M4 x 21	8 x 15	7 x 1.5
CBC.35	POF/35	POF35	M4 x 21	8 x 12	10 x 4
CBD.16	POF/44	POF44	M4 x 16	6 x 9.5	7 x 1.5
CBD.35	POF/06	POF06	M4 x 21	8 x 12	8 x 2.5
CBD.50	POF/07	POF07	M5 x 20	8 x 12	10 x 2.5
CBD.70	POF/08	POF08	M5 x 25	8 x 15	10 x 2.5
NCS	POF/99	POF99	M3 x 5	-	5.5 x 0.6
NCV	POF/99	POF99	M3 x 5	-	5.5 x 0.6
RFI.2	POF/17	POF17	M2.5 x 13.5	4 x 8	4 x 0.8
SCB.6	POF/57	POF57	M3.5 x 28	6 x 19	7 x 1
SCB.10	POF/56	POF56	M4.5 x 20	7 x 13.5	7 x 1.5
SCX.10	POF/56	POF56	M4.5 x 12	7 x 13.5	7 x 1.5
SFO.4	POF/20	POF20	M3 x 20	4 x 16	5.5 x 0.6
SV.2	POF/11	POF11	M2.5 x 13.5	4 x 10	5.5 x 0.6
SV.4	POF/12	POF12	M3 x 14	4 x 10	5.5 x 0.6
SV.6	POF/13	POF13	M3 x 20	5.5 x 13.5	7 x 1
SV.10	POF/14	POF14	M3.5 x 21	5.5 x 16	7 x 1.5
VL.16	POF/55	POF55	M4 x 12	6 x 6.5	8 x 2
VLM.10	POF/54	POF54	M4 x 12	5.5 x 7.5	7 x 1.5
GPM.95 (2 poles)	POF/95/2	PO952	M5 x 20	-	10 x 10
GPM.95 (3 poles)	POF/95/3	PO953	M5 x 20	-	10 x 10
GPM.150 (2 poles)	POF/150/2	PO152	M5 x 20	-	10 x 10
GPM.150 (3 poles)	POF/150/3	PO153	M5 x 20	-	10 x 10
GPM.240 (2 poles)	POF/240/2	PO242	M5 x 30	-	10 x 15
GPM.240 (3 poles)	POF/240/3	PO243	M5 x 30	-	10 x 15
GPA.70 - GPA.70/FIX	POF/70	POF70	M5 x 35	8 x 23.5	10 x 3

[1] For terminal blocks that normally require POF connections, where they are to be inserted in "increased safety" installations (Ex e), the use of PFX cross connections is required; they include an anti-loosening washer

The PMP commoning bar, suitable for multiple connection of several terminal blocks, whether adjacent or not, is supplied in 250 mm sections with holes adequate for the pitch of each terminal block. The bar is supported and fixed, in correspondence with each element, by a special CPM sleeve screw.

In use on terminal boards destined for "increased safety" (Ex e) plants the CPM screws/sleeves are fitted with self-locking washers and their part number is changed to CPX.



TERMINAL BLOCK	COMMONING BAR		L X S MM	SCREW/SLEEVE		SCREW/SLEEVE (EX E)	
	TYPE	CODE		TYPE	CODE	TYPE	CODE
CBC.16	PMP/05	PMP05	7 x 1.5	CPM/53	CPM53	CPX/53	CPX53
CBC.35	PMP/35	PMP35	10 x 4	CPM/35	CPM35	CPX/35	CPX35
CBD.2	PMP/01	PMP01	5.5 x 0.6	CPM/21	CPM21	CPX/21	CPX21
CBD.4	PMP/42	PMP42	5.5 x 0.6	CPM/12	CPM12	CPX/12	CPX12
CBD.6	PMP/13	PMP13	7 x 1	CPM/83	CPM83	CPX/83	CPX83
CBD.10	PMP/04	PMP04	7 x 1.5	CPM/03	CPM03	CPX/03	CPX03
CBD.16	PMP/05	PMP05	7 x 1.5	CPM/44	CPM44	CPX/44	CPX44
CBD.35	PMP/06	PMP06	8 x 2.5	CPM/06	CPM06	CPX/06	CPX06
CBD.50	PMP/07	PMP07	10 x 2.5	CPM/07	CPM07	CPX/07	CPX07
CBD.70	PMP/08	PMP08	10 x 2.5	CPM/08	CPM08	CPX/08	CPX08
CBR.2	PMP/25	PMP25	5.5 x 0.6	CPM/25	CPM25	-	-
CVF.4	PMP/58	PMP58	5.5 x 0.6	CPM/12	CPM12	-	-
DAS.4	PMP/58	PMP58	5.5 x 0.6	CPM/01	CPM01	CPX/01	CPX01
FFS.4	PMP/42	PMP42	5.5 x 0.6	CPM/01	CPM01	CPX/01	CPX01
FVS.4	PMP/42	PMP42	5.5 x 0.6	CPM/01	CPM01	CPX/01	CPX01
GPA.70 - GPA.70/FIX	PMP/08	PMP08	10 x 2.5	CPM/70	CPM70	-	-
NCS	PMP/02	PMP02	5.5 x 0.6	CPM/99	CPM99	-	-
NCV	PMP/02	PMP02	5.5 x 0.6	CPM/99	CPM99	-	-
RFI.2	PMP/17	PMP17	4 x 0.8	CPM/17	CPM17	-	-
RN.1	PMP/16	PMP16	5.5 x 0.6	CPM/16	CPM16	-	-
RN.2	PMP/25	PMP25	5.5 x 0.6	CPM/16	CPM16	CPX/16	CPX16
RP.4	PMP/58	PMP58	5.5 x 0.6	CPM/01	CPM01	CPX/01	CPX01
SCB.4	PMP/02	PMP02	5.5 x 0.6	CPM/01	CPM01	-	-
SCB.6	PMP/13	PMP13	7 x 1	CPM/57	CPM57	-	-
SCB.10	PMP/56	PMP56	7 x 1.5	CPM/56	CPM56	-	-
TDE.2	PMP/02	PMP02	5.5 x 0.6	CPM/21	CPM21	-	-
TLD.2	PMP/02	PMP02	5.5 x 0.6	CPM/21	CPM21	-	-
TLE.2	PMP/02	PMP02	5.5 x 0.6	CPM/21	CPM21	-	-
TLS.2	PMP/02	PMP02	5.5 x 0.6	CPM/21	CPM21	-	-

If the linking of adjacent terminal blocks is occasional, a POS switchable cross connection may be used; it consists of:

- 2 screws
- 2 sleeves
- 1 linking plate with open slot, allowing easy opening and closing of the cross connection



TERMINAL BLOCK	CROSS CONNECTION		SCREW M X L (MM)	SLEEVE Ø X L (MM)
	TYPE	CODE		
CBC.16	POS/53	POS53	4 x 35	5.1 x 30
CBD.2	POS/11	POS11	2.5 x 22	4 x 18
CBD.4	POS/42	POS42	3 x 28	4 x 23
CBD.6	POS/93	POS93	3.5 x 27	5.5 x 21.5
CBD.10	POS/44	POS44	4 x 30	5.5 x 21.5
CBD.16	POS/44	POS44	4 x 30	5.5 x 21.5
CBD.35	POS/66	POS66	4 x 30	8 x 23.5
CBD.50	POS/77	POS77	5 x 30	8 x 23.5
CBD.70	POS/08	POS08	5 x 40	8 x 30
DAS.4	POS/43	POS43	3 x 20	4 x 16
FFS.4	POS/72	POS72	3 x 20	4 x 14.5
FVS.4	POS/72	POS72	3 x 20	4 x 14.5
TLD.2	POS/41	POS41	2.5 x 16	4 x 12.7
TLS.2	POS/41	POS41	2.5 x 16	4 x 12.7
RP.4	POS/43	POS43	3 x 20	4 x 16

The modular test plugs make it possible to carry out the final check on terminal boards already wired or a simple derivation. The tester is positioned directly in the housing of the terminal block like a normal test plug. The extreme simplicity of the modularity makes it possible to assemble the tester in a number of poles according to the various needs.

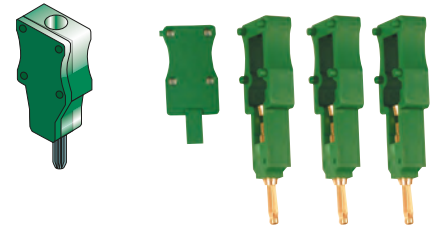

MODULAR TEST PLUGS FOR SCREW CLAMP TERMINAL BLOCKS

	CODE TYPE	DD005 SDD/5	DD006 SDD/6	DD501 SD5/PT	DD601 SD6/PT
DESCRIPTION		pitch 5.5 mm. for terminal blocks type CBD.2	pitch 6.5 mm. for terminal blocks type CBD.4	closing element for SDD/5	closing element for SDD/6

	CODE TYPE	DC005 SDC/5	DC006 SDC/6	DC05P SDC/5P	DC06P SDC/6P
DESCRIPTION		pitch 5 mm. for terminal blocks type CBC.2/GR	pitch 6 mm. for terminal blocks type CBC.4/GR	version to be used with PTC jumper	version to be used with PTC jumper

	CODE TYPE	DC05V SDC/5V	DC06V SDC/6V	DCPOL SDC/PO/L
DESCRIPTION		intermediate distancing element	intermediate distancing element	polarising element

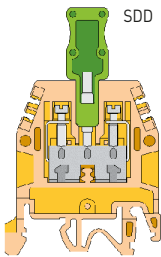

SDD

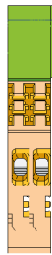

closing
element
SD.x/PT



SDC/6 once mounted



SDC/6-P once mounted

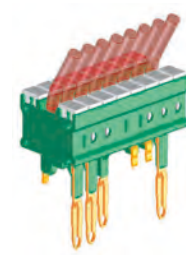

SDC/6 with cable composition

TEST PLUGS FOR SPRING-CLAMP TERMINAL BLOCKS

	CODE TYPE	DH004 SDH/4	DH005 SDH/5	DH006 SDH/6	DH007 SDH/7
DESCRIPTION		pitch 4.2 mm for terminal blocks: HMM.1, HMM.1/1+2, HMM.1/2+2, HMD.1	pitch 5.2 mm for terminal blocks HMM.2 - HMM.2/1+2 - HMM.2/2+2 - HMD.2 - HMS.2 - HP.2 Series - HP.2/P	pitch 6.2 mm for HMM.4 terminal blocks	pitch 5.2 mm for terminal blocks HMD.2N/GR, HMD.2N/X/GR, HMD.2N/X1/GR

	CODE TYPE	DH401 SH4/PT	DH501 SH5/PT	DH601 SH6/PT	DH701 SH7/PT
DESCRIPTION		closing element for SDH/4	closing element for SDH/5	closing element for SDH/6	closing element for SDH/7

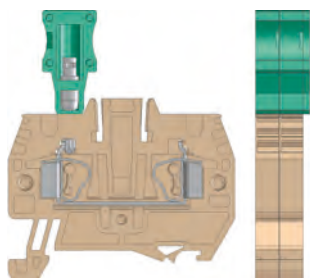

SDH

For measurements and checks on circuits which are related to the terminal boards, the following special items can be supplied:

- insulated sockets (PSD) screwable onto the conductor body of the terminal blocks.
- plugs (SDD) of the bundle type, made of silver-plated brass.



TERMINAL BLOCK	SOCKET		INTERNAL SOCKET Ø (MM)	PLUG		PLUG Ø (MM)
	TYPE	CODE		TYPE	CODE	
CBC.16	PSD/B	PD002	4.05	SDD/2	DD002	4
CBC.35	PSD/B	PD002	4.05	SDD/2	DD002	4
CBD.2	PSD/D	PD004	2.35	SDD/1	DD001	2.3
CBD.4	PSD/A	PD001	2.35	SDD/1	DD001	2.3
CBD.6	PSD/N	PD013	2.35	SDD/1	DD001	2.3
CBD.10	PSD/B	PD002	4.05	SDD/2	DD002	4
CBD.16	PSD/B	PD002	4.05	SDD/2	DD002	4
CBD.35	PSD/B	PD002	4.05	SDD/2	DD002	4
CBD.50	PSD/C	PD003	4.05	SDD/2	DD002	4
CBD.70	PSD/C	PD003	4.05	SDD/2	DD002	4
CBR.2	PSD/K	PD011	2.35	SDD/1	DD001	2.3
CVF.4	PSD/A	PD001	2.35	SDD/1	DD001	2.3
DAS.4	PSD/A	PD001	2.35	SDD/1	DD001	2.3
FDP.2	-	-	-	SDD/1	DD001	2.3
FFS.4	PSD/A	PD001	2.35	SDD/1	DD001	2.3
FPC.10	-	-	-	SDD/2	DD002	4
FVS.4	PSD/A	PD001	2.35	SDD/1	DD001	2.3
HMD.2	-	-	-	SDD/1	DD001	2.3
HMM.2	-	-	-	SDD/1	DD001	2.3
HMM.2/1+2	-	-	-	SDD/1	DD001	2.3
HMM.2/2+2	-	-	-	SDD/1	DD001	2.3
HMM.2/1+2/S	-	-	-	SDD/1	DD001	2.3
HMM.2/2+2/S	-	-	-	SDD/1	DD001	2.3
HMM.4	-	-	-	SDD/1	DD001	2.3
HMM.4/1+2	-	-	-	SDD/1	DD001	2.3
HMM.4/2+2	-	-	-	SDD/1	DD001	2.3
HMM.6	-	-	-	SDD/1	DD001	2.3
HMM.10	-	-	-	SDD/1	DD001	2.3
HMM.16	-	-	-	SDD/1	DD001	2.3
HMS.2	-	-	-	SDD/1	DD001	2.3
HTE.2	-	-	-	SDD/1	DD001	2.3
HSCB.6	PSD/O	PD017	2.35	SDD/1	DD001	2.3
HTE.2/1+2	-	-	-	SDD/1	DD001	2.3
HTE.2/2+2	-	-	-	SDD/1	DD001	2.3
HTE.4	-	-	-	SDD/1	DD001	2.3
HTE.6	-	-	-	SDD/1	DD001	2.3
HVPC.2	-	-	-	SDD/1	DD001	2.3
MAC.6	-	-	-	SDD/1	DD001	2.3
MPS.2	PSD/K	PD011	2.35	SDD/1	DD001	2.3
NCS	PSD/K	PD011	2.35	SDD/1	DD001	2.3
NCV	PSD/K	PD011	2.35	SDD/1	DD001	2.3
RN.1	PSD/K	PD011	2.35	SDD/1	DD001	2.3
RFL.2	PSD/K	PD011	2.35	SDD/1	DD001	2.3
RN.2	PSD/A	PD001	2.35	SDD/1	DD001	2.3
RP.4	PSD/A	PD001	2.35	SDD/1	DD001	2.3
SCB.4	PSD/A	PD001	2.35	SDD/6-SDD/1	DD006-DD001	2.3
SCB.6	PSD/P	PD015	4.05	SDD/2	DD002	4
SCB.10	PSD/L	PD009	4.05	SDD/2	DD002	4
SFC.10	-	-	-	SDD/2	DD002	4
SFR.4	PSD/J	PD014	2.35	SDD/1	DD001	2.3
TDE.2	PSD/D	PD004	2.35	SDD/1	DD001	2.3
TLD.2	PSD/D	PD004	2.35	SDD/1	DD001	2.3
TLE.2	PSD/D	PD004	2.35	SDD/1	DD001	2.3
TLS.2	PSD/D	PD004	2.35	SDD/1	DD001	2.3

- CPF05 can be mounted on MPFA.4, DSFA.4 and HMFA.2 terminal blocks
- CPFE02 and CPFE04 can be mounted on EFS and EFDS series
- possible insertion of Ø 5 x 20 mm fuse (our type F5, with or without warning LED, diode [1 or 3 A], Ø 5 x 20 mm brass cylinder and other components (e.g. resistances)

(1) with fuse Ø 5 x 20 mm, 250 V, I_{max} = 6,3 A - with brass pin I_{max} = 10 A
 (2) the height depends on the mounting on relative terminal blocks and the din rail (see table)



GREEN VERSION	CODE	CPF05	CPFE02	CPFE04
	TYPE	CPF/5	CPFE/2	CPFE/4

TECHNICAL CHARACTERISTICS

Function/type		component holder cartridge	component holder cartridge	component holder cartridge
Electrical characteristics	Max AC/DC Voltage	320 (1)	630 (1)	630 (1)
According to European standard IEC EN 60947-7-1	Max current with rated cross-section	6,3 (1)	6,3 (1)	6,3 (1)
	Section	-	-	-
Rated impulse withstand voltage/pollution degree		4 kV / 3	4 kV / 3	4 kV / 3
Width	(mm)	33	30	30
Length	(mm)	6	6	6
Height mounted on TH35/7,5	(mm)	(2)	(2)	(2)
Height mounted on TH35/15	(mm)	(2)	(2)	(2)
Height mounted on G32	(mm)	(2)	(2)	(2)
Insulation material temperature index (EN 60216-1)	(°C)	130	130	130
Plastic material		polyamide UL94V-0	polyamide UL94V-0	polyamide UL94V-0

APPROVALS

ACCESSORIES			
Marking tag		CNU/8/51 (cod. NU0851S)	CNU/8/51 (cod. NU0851S)
Tinned brass conductor		CO/5 (cod. VL103)	CO/5 (cod. VL103)
Cartridge / insert with 1 A diode		SFR/11A (cod. SF992)	SFR/11A (cod. SF992)
Cartridge / insert with 3 A diode		SFR/13A (cod. SF993)	SFR/13A (cod. SF993)
LED circuit non-polarized	for voltage 12V 24V 48V AC/DC	-	CIL/12-24-48 (cod. SF518)
	for voltage 115V 230V AC/DC	-	CIL/115-230 (cod. SF510)
VERSIONS PROVIDED			
With non-polarized LED microcircuit 12 Vdc / Vac		CPF/5L12 (cod. CPF512)	-
With non-polarized LED microcircuit 24 Vdc / Vac		CPF/5L24 (cod. CPF524)	-
With non-polarized LED microcircuit 48 Vdc / Vac		CPF/5L48 (cod. CPF548)	-
With non-polarized LED microcircuit 115 Vdc / Vac		CPF/5L115 (cod. CPF511)	-
With non-polarized LED microcircuit 230 Vdc / Vac		CPF/5L230 (cod. CPF523)	-
With 1 A diode (1N4001 ÷ 1N4007 types)		CPF/5D1A (cod. CPF501)	-
With 3 A diode (BY255 type)		CPF/5D3A (cod. CPF503)	-
With resistor 1200 Ω (1 W ± 5%)		CPF/5R (cod. CPR05)	-

Terminal block	Height on rail TH/35 7.5 (mm)	Height on rail TH/35 15 (mm)	Height on rail G32 (mm)
HMFA.2	57	75	-
MPFA.4	75	83	79
DSFA.4	96	104	100
EFS.2	61.2	68.7	-
EFS.4	61.2	68.7	-
EFDS.2/GR	74	81.5	-
EFDS.2/15/GR	74	81.5	-

MAX. DISSIPATED POWER - IN CONF. WITH IEC 60947-7-3

Terminal block	Voltage [V] (*)	Current [A]	Protection against overload and short circuit		Only protection against short circuit	
			Single configuration (PV) - [W]	Composite configuration (PV) - [W]	Single configuration (PVK) - [W]	Composite configuration (PVK) - [W]
MPFA.4 + CPF/5	250	6.3	1.6	1.6	4	1.6
DSFA.4 + CPF/5	250	6.3	1.6	1.6	4	1.6
HMFA.2 + CPF/5	250	6.3	1.6	1.6	4	1.6

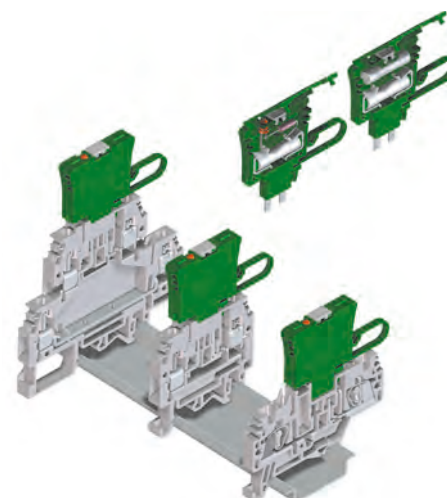

TYPE	CODE		
SCB/6/ PO/2	SB203	Short circuit plate for two adjacent SCB.6 terminal blocks	
SCB/6/ PO/4	SB204	Short circuit plate for four adjacent SCB.6 terminal blocks	
HSCB/6/ PO/2	HB203	Short circuit plate for two adjacent HSCB.6 terminal blocks	
HSCB/6/ PO/4	HB204	Short circuit plate for four adjacent HSCB.6 terminal blocks	
SCB/4/ PO/2	SB303	Short circuit plate for two adjacent SCB.4 terminal blocks	
SCB/4/ PO/4	SB304	Short circuit plate for four adjacent SCB.4 terminal blocks	
SCX/PO/2	SC103	Short circuit plate for two adjacent SCX.10 terminal blocks	
SCX/PO/4	SC104	Short circuit plate for four adjacent SCX.10 terminal blocks	
FVS/VCI	FV107	Screw and sleeve to perform the internal link between the front and back conducting bodies of FVS.4 terminal block	
FVS/VCE	FV108	Screw and sleeve to perform the internal and external link between the front and back conducting bodies of FVS.4 terminal blocks.	

TYPE	CODE		
DAS/VCI	DS107	Screw and sleeve for internal connection between the front conductor body and the rear one of the DAS.4	
DAS/VCE	DS108	Screw and sleeve for internal connection between the front and rear conductor bodies and external connection between the conductor bodies of contiguous terminal blocks, for the DAS.4	
CO/5	VL103	Ø 5 x 20 mm - in brass for terminal block types: SFO.4 - SFR.4 - SFR.6/M - FLD.10/F5 - HMF.4 - VLM.10	
SFC/CO	FC102	Ø 6,3 x 32 mm - in brass for terminal block types: FPC.10 - SFC.10 - SFR.6 - with possible derivation by means of plug SDD/2	
CBD/SH	CB009	For the connection of the cable shielding - to be used on terminal blocks type CBD.2, 4, 6, 10.	
SCB/6/ CPM	SB205	Sleeve to be used with SCB/6/PO link	
HSCB/6/ CPM	HB205	Sleeve to be used with HSCB/6/PO link	
SCB/4/ CPM	SB305	Sleeve to be used with SCB/4/PO link	
SCX/CPM	SC105	Sleeve to be used with SCX/PO link (*)	

(*) they are supplied mounted as in A. It is necessary to remove, as in pos. B, the one to introduce into the platelet slot, put it back and screw it onto the body of the terminal block.

According to the IEC 60127-2-1- standard with rapid burn-out for voltage 250 V. In small steatite tube filled with spark-quenching powder (interruption power 1500 A).

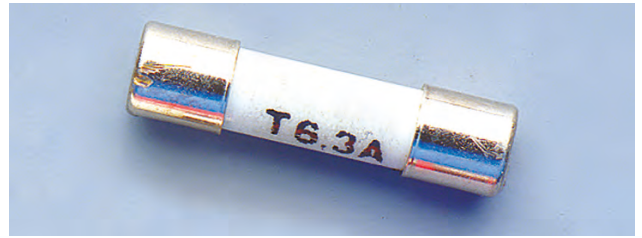

RATED CURRENT	Ø 5 X 20 MM FUSE WITHOUT MARKING		APPROVALS
	TYPE	CODE	
100 mA	F5/100 mA	FN001ST	-
200 mA	F5/200 mA	FN002ST	-
315 mA	F5/315 mA	FN003ST	-
500 mA	F5/500 mA	FN004ST	RINA 5/18/75 homologation - 220V - 50 Hz - 1500 A
630 mA	F5/630 mA	FN005ST	RINA 5/18/75 homologation - 220V - 50 Hz - 1500 A
1A	F5/1 A	FN006ST	RINA 5/18/75 homologation - 220V - 50 Hz - 1500 A
1.6 A	F5/1.6 A	FN007ST	RINA 5/18/75 homologation - 220V - 50 Hz - 1500 A
2A	F5/2 A	FN008ST	RINA 5/18/75 homologation - 220V - 50 Hz - 1500 A
2.5 A	F5/2.5 A	FN009ST	RINA 5/18/75 homologation - 220V - 50 Hz - 1500 A
3.15 A	F5/3.15 A	FN010ST	RINA 5/18/75 homologation - 220V - 50 Hz - 1500 A
4A	F5/4 A	FN011ST	RINA 5/18/75 homologation - 220V - 50 Hz - 1500 A
5A	F5/5 A	FN012ST	RINA 5/18/75 homologation - 220V - 50 Hz - 1500 A
6.3 A	F5/6.3 A	FN013ST	RINA 5/18/75 homologation - 220V - 50 Hz - 1500 A
8A	F5/8 A	FN014ST	RINA 5/18/75 homologation - 220V - 50 Hz - 1500 A
10A	F5/10 A	FN015ST	RINA 5/18/75 homologation - 220V - 50 Hz - 1500 A
12A	F5/12 A	FN016ST	RINA 5/18/75 homologation - 220V - 50 Hz - 1500 A

LSN TORPEDO PILOT BULBS F5 FUSES

CODE	TECHNICAL CHARACTERISTIC
FL201	Festoon light bulb Ø 6 x 26 mm, with stabiliser resistance incorporated, for voltage between 12 V AC and 48 V AC, for use on FLD.10/F5L, FLD.10/F6, FPL.10 terminal blocks.
FL202	Festoon light bulb Ø 6 x 26 mm, with stabiliser resistance incorporated, for voltage between 70 V AC and 380 V AC, for use on FLD.10/F5L, FLD.10/F6, FPL.10 terminal blocks.
KIT1224	For SFR.6 and SFR.6/M terminal blocks.
KIT70380	For SFR.6 and SFR.6/M terminal blocks.

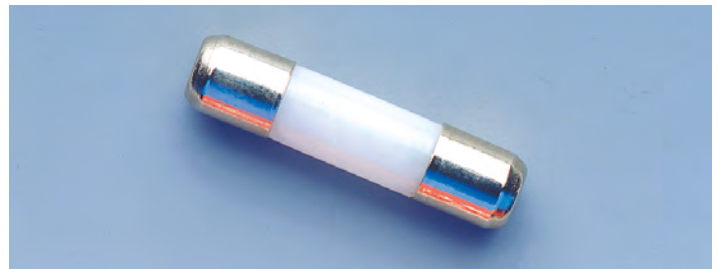

CIL SIGNAL CIRCUIT

For signalling the status of fuse-holder terminal blocks types SFR.4 - MAC.6 and FPL.10. Suitable for use in circuits powered both in D.C. and A.C.

Each packet is supplied with:

- two contact blades
- one non-polarised LED microcircuit
- one transparent protection.

The components are inserted inside the terminal block in this sequence

TYPE	CODE	RATED VOLTAGE [V DC - V AC]	CURRENT L.R.M.S. [A] (*)
CIL/12-48	SF518	12-48	3.0 mA
CIL/115-230	SF510	115-230	2.3 mA

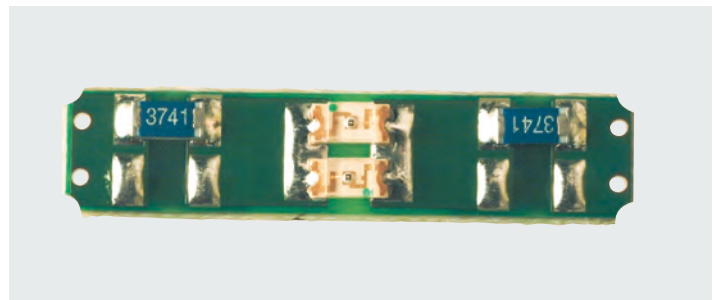

Made of red polyamide, thickness 1.5 mm, to be placed to separate the elements on the terminal board to enable easy identification of certain circuits or to increase the insulation distances between the terminal blocks. The partitions can also be used to increase the insulation distances between adjacent cross connections or multiple parallel platelets.

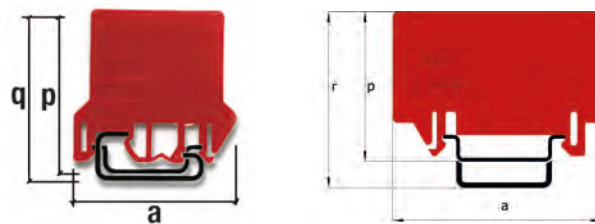

NOTE
 (1) q dimension can be obtained by adding 4 mm to dimension p
 (2) r dimension can be obtained by adding 7.5 mm to dimension p

TERMINAL BLOCK	PARTITION		DIMENSIONS A X P
	TYPE	CODE	
SCREW-CLAMP TERMINAL BLOCKS			
AFO.2/1+1	DFU/1/R	DU01R	52 x 51
AFO.2/2+2	DFU/1/R	DU01R	52 x 51
CBC.2	DFU/4/R	DU04R	52 x 62
CBC.4	DFU/4/R	DU04R	52 x 62
CBC.6	DFU/4/R	DU04R	52 x 62
CBC.10	DFU/4/R	DU04R	52 x 62
CBC.16	DFU/4/R	DU04R	52 x 62
CBC.35	DFU/5/R	DU05R	62 x 68
CBD.2	DFU/1/R	DU01R	52 x 51
CBD.4	DFU/4/R	DU04R	52 x 62
CBD.6	DFU/4/R	DU04R	52 x 62
CBD.10	DFU/4/R	DU04R	52 x 62
CBD.16	DFU/4/R	DU04R	52 x 62
CBD.35	DFU/5/R	DU05R	62 x 68
CBD.50	DFU/5/R	DU05R	62 x 68
CBD.70	DFU/6/R	DU06R	72 x 74
CBE.2	DFU/4/R	DU04R	52 x 62
CBR.2	DFU/4/R	DU04R	52 x 62
CVF.4	DFU/3/R	DU03R	68 x 57
DAS.4	DFU/7/R	DU07R	80 x 64
DBC.2	DFU/7/R	DU07R	80 x 64
DSF.4	DFU/7/R	DU07R	80 x 64
DSFA.4	DFU/7/R	DU07R	80 x 64
DSS.4	DFU/7/R	DU07R	80 x 64
FDP.2	DFU/5/R	DU05R	62 x 68
FLD.10/...	DFU/6/R	DU06R	72 x 74
FPC.10	DFU/6/R	DU06R	72 x 74
FPL.10	DFU/6/R	DU06R	72 x 74
FVS.4	DFU/6/R	DU06R	72 x 74
MPFA.4	DFU/3/R	DU03R	68 x 57
NCS	DFU/2/R	DU02R	52 x 54
NCV	DFU/2/R	DU02R	52 x 54
PDF.2	DFU/5/R	DU05R	62 x 68
RFI.2	DFP/2/R	DFP2R	37 x 38
RN.1	DFP/2/R	DFP2R	37 x 38
RN.2	DFP/2/R	DFP2R	37 x 38
RP.4	DFP/2/R	DFP2R	37 x 38
SCB.4	DFU/3/R	DU03R	68 x 57
SCB.6	DFU/6/R	DU06R	72 x 74
SCB.6/DD	DFU/6/R	DU06R	72 x 74
SCB.10	DFU/7/R	DU07R	80 x 64
SCB.10/CD	DFU/7/R	DU07R	80 x 64
SCB.10/DD	DFU/7/R	DU07R	80 x 64
SCB.6/CD	DFU/6/R	DU06R	72 x 74
SFR.4	DFU/3/R	DU03R	68 x 57
SFR.6	DFU/7/R	DU07R	80 x 64
TC/PO	DFU/1/R	DU01R	52 x 51
TDE.2	DFU/3/R	DU03R	68 x 57
TLD.2	DFU/3/R	DU03R	68 x 57
TLE.2	DFU/3/R	DU03R	68 x 57
TLS.2	DFU/3/R	DU03R	68 x 57
VPC.2	DFU/5/R	DU05R	62 x 68
VPD.2	DFU/7/R	DU07R	80 x 64

TERMINAL BLOCK	PARTITION		DIMENSIONS A X P
	TYPE	CODE	
SPRING-CLAMP TERMINAL BLOCKS			
HCD.1	DFU/7/R	DU07R	80 x 64
HMD.2	DFH/4/R	DH04R	97 x 51.5
HFR.4	DFH/4/R	DH04R	97 x 51.5
HMFA.2	DFH/2/R	DH02R	76 x 42.5
HMM.2	DFH/1/R	DH01R	64 x 42.5
HMM.2/1+2	DFH/2/R	DH02R	76 x 42.5
HMM.2/2+2	DFH/3/R	DH03R	88 x 42.5
HMM.2/2+2/S	DFH/3/R	DH03R	88 x 42.5
HMM.4	DFH/1/R	DH01R	64 x 42.5
HMM.4/1+2	DFH/4/R	DH04R	97 x 51.5
HMM.4/2+2	DFH/4/R	DH04R	97 x 51.5
HMM.6	DFH/1/R	DH01R	64 x 42.5
HMM.10	DFH/4/R	DH04R	97 x 51.5
HMM.16	DFH/4/R	DH04R	97 x 51.5
HVPC.2	DFH/1/R	DH01R	64 x 42.5
HMS.2	DFH/2/R	DH02R	76 x 42.5
HPP.2	DFP/2/R	DFP2R	37 x 38
HPP.2/P	DFP/2/R	DFP2R	37 x 38
HTE.2	DFH/1/R	DH01R	64 x 42.5
HTE.2/1+1	DFH/2/R	DH02R	76 x 42.5
HTE.2/2+2	DFH/3/R	DH03R	88 x 42.5
HTE.4	DFH/1/R	DH01R	64 x 42.5
HTE.6	DFH/1/R	DH01R	64 x 42.5
HMM.1	DFH/1/R	DH01R	64 x 42.5
HMM.1/1+2	DFH/3/R	DH03R	88 x 42.5
HMM.1/2+2	DFH/2/R	DH02R	76 x 42.5
HMD.1	DFU/7/R	DU07R	80 x 64
HMD.2N	DFU/7/R	DU07R	80 x 64
HMM.2/1+2/S	DFH/2/R	DH02R	76 x 42.5
HSCB.4	DFH/4/R	DH04R	97 x 51.5
HTE.1	DFH/1/R	DH01R	64 x 42.5
HTE.1/1+2	DFH/2/R	DH02R	76 x 42.5
HTE.1/2+2	DFH/3/R	DH03R	88 x 42.5

TERMINAL BLOCK	PARTITION		DIMENSIONS A X P
	TYPE	CODE	
EFC TERMINAL BLOCKS			
EFC.2	DFE.1+1/R	DFE01R	59.2 x 42.5
EFC.2/1+2	DFE.1+2/R	DFE02R	75.8 x 42.5
EFC.2/2+2	DFE.2+2/R	DFE03R	92.4 x 42.5
EFCE.2	DFE.1+1/R	DFE01R	59.2 x 42.5
EFCE.2/1+2	DFE.1+2/R	DFE02R	75.8 x 42.5
EFCE.2/2+2	DFE.2+2/R	DFE03R	92.4 x 42.5
EFC.4	DFE.1+1/R	DFE01R	59.2 x 42.5
EFC.4/1+2	DFE.1+2/R	DFE02R	75.8 x 42.5
EFC.4/2+2	DFE.2+2/R	DFE03R	92.4 x 42.5
EFCE.4	DFE.1+1/R	DFE01R	59.2 x 42.5
EFCE.4/1+2	DFE.1+2/R	DFE02R	75.8 x 42.5
EFCE.4/2+2	DFE.2+2/R	DFE03R	92.4 x 42.5
EFD.2	DFE.2P/R	DFE04R	84.7 x 59.5
EFD.2/CI	DFE.2P/R	DFE04R	84.7 x 59.5
EFD.2/E	DFE.2P/R	DFE04R	84.7 x 59.5
EFD.4	DFE.2P/R	DFE04R	84.7 x 59.5
EFD.4/CI	DFE.2P/R	DFE04R	84.7 x 59.5
EFD.4/E	DFE.2P/R	DFE04R	84.7 x 59.5
EFDE.2	DFE.2P/R	DFE04R	84.7 x 59.5
EFDE.4	DFE.2P/R	DFE04R	84.7 x 59.5
EFF.4	DFE.1+1/R	DFE01R	59.2 x 42.5
EFF.4/C48	DFE.1+1/R	DFE01R	59.2 x 42.5
EFF.4/C230	DFE.1+1/R	DFE01R	59.2 x 42.5
EFS.2	DFE.1+1/R	DFE01R	59.2 x 42.5
EFS.4	DFE.1+1/R	DFE01R	59.2 x 42.5
EFT.2	-	-	-
EFT.2	-	-	-
EFT.2/S	-	-	-
EFDS.2	-	-	-
EFDS.2/1S	-	-	-
EFDS.2/P	-	-	-

ACCESSORIES

Made of red polyamide, indispensable for guaranteeing the insulation distance between fixed or switchable cross connections inserted between adjacent pairs of terminal blocks and, in the same way, between multiple parallel platelets, inserted between adjacent groups of terminal blocks.

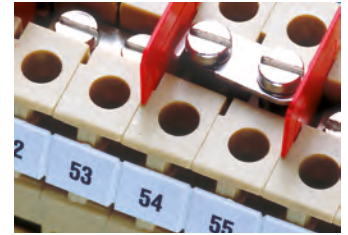
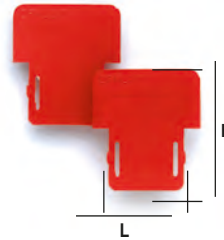

TERMINAL BLOCK	PARTITION		DIMENSIONS L X H	THICKNESS MM
	TYPE	CODE		
CBC.2	DFM/900	DF900	17 x 18	0.5
CBC.2	DFM/800	DF800	17 x 18	0.5
CBC.4	DFM/900	DF900	17 x 18	0.5
CBC.4	DFM/800	DF800	17 x 18	0.5
CBC.6	DFM/900	DF900	17 x 18	0.5
CBC.6	DFM/800	DF800	17 x 18	0.5
CBC.10	DFM/900	DF900	17 x 18	0.5
CBC.10	DFM/800	DF800	17 x 18	0.5
CBC.16	DFM/700	DF700	28 x 32	0.5
CBC.35	DFM/700	DF700	28 x 32	0.5
CBD.2	DFM/600	DF600	24 x 31	0.5
CBD.4	DFM/600	DF600	24 x 31	0.5
CBD.6	DFM/600	DF600	24 x 31	0.5
CBD.10	DFM/700	DF700	28 x 32	0.5
CBD.16	DFM/700	DF700	28 x 32	0.5
CBD.35	DFM/700	DF700	28 x 32	0.5
CBD.50	DFM/700	DF700	28 x 32	0.5
CBD.70	DFM/700	DF700	28 x 32	0.5
DBC.2	DFM/900	DF900	17 x 18	0.5
DBC.2	DFM/800	DF800	17 x 18	0.5
DBC.2	DFM/500	DF500	4.6 x 13.5	0.5
DSS.4	DFM/500	DF500	4.6 x 13.5	0.5
DSFA.4	DFM/500	DF500	4.6 x 13.5	0.5
HDE.2	DFM/500	DF500	4.6x13.5	0.5
HLD.2	DFM/500	DF500	4.6x13.5	0.5
HMM.1	DFM/500	DF500	4.6 x 13.5	0.5
HMM.1/1+2	DFM/500	DF500	4.6 x 13.5	0.5
HMM.1/2+2	DFM/500	DF500	4.6 x 13.5	0.5
HMD.1	DFM/500	DF500	4.6 x 13.5	0.5
HMD.2/N	DFM/500	DF500	4.6 x 13.5	0.5
MPS.4	DFM/500	DF500	4.6 x 13.5	0.5
MPFA.4	DFM/500	DF500	4.6 x 13.5	0.5
TLD.2	DFM/400	DF400	10 x 18	0.5
TLS.2	DFM/400	DF400	10 x 18	0.5
VPC.2	DFM/300	DF300	9.4 x 12.9	0.4
VPD.2	DFM/300	DF300	9.4 x 12.9	0.4

For protecting from accidental contacts or tampering CDA and ACB Series terminal blocks.
Made of self-extinguishing and transparent material of thickness 2.3 mm and fixed length 200 mm [corresponding to the total width of the four terminal blocks side-by-side].

The covers are available in three sizes:

- **PRT/P** 22 x 125 mm [Cat.No. PRT01] for protecting ACB/BB terminal blocks
- **PRT/M 50** 50 x 125 mm [Cat.No. PRT02] for protecting ACB/CC terminal blocks
- **PRT/G 85** 85 x 125 mm [Cat.No. PRT03] to be used when the conductors come from the backboard, or in order to protect a connection point not yet connected.

The PRT covers must be inserted on SPS supports, made of self-extinguishing ABS / class UL94V-0, thickness 5 mm, interposed between contiguous terminal blocks. Protection of the four terminal blocks side-by-side is achieved by means of overlapping coupling of two PRTs.

Note:
The ID Cat. No. (i.e. PRT01) is referred to a single item.

[*] height including rail



PZM.4 COVER

(a = 64+2 mm / b = 32 mm)

Cat. No. **PZ330**

For terminal blocks of size up to approximately 58 mm (including rail).

To be mounted with **PZD.4/SO supports** (Cat. No. PZ331)

Maximum size PZM.4 + PZD.4/SO

- on rail IEC 60715/G32 = 70 or 82 mm (*)
- on rail IEC 60715/TH35 = 65 or 77 mm (*)

(*) depending on the notches used, upper or lower.

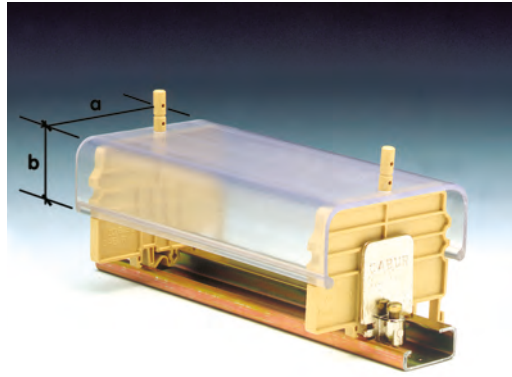

PZM.4 - PZM.6 channel

Made of **PVC** for protecting from accidental contacts or tampering terminal blocks up to a section of 70 mm².

They are supplied in 2 m lengths and are to be mounted on specific polyamide supports, insertable on PR/DIN and PR/3 support rails, types "G32" and TH/35. They can be made unmovable with sealing of the support appendices.

PZM.6 COVER

(a = 85+2 mm / b = 36 mm)

Cat. No. **PZ110**

For terminal blocks of size of more than approximately 58 mm (including rail).

To be mounted with **PZD.6/SO supports** (Cat. No. PZ112)

Maximum size PZM.6 + PZD.6/SO

- on rail IEC 60715/G32 = 82 or 94 mm (*)
- on rail IEC 60715/TH35 = 78 or 90 mm (*)

(*) depending on the notches used, upper or lower.

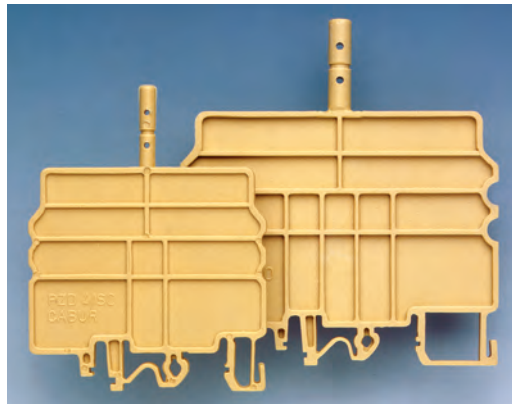

PZD.4/SO - PZD.6/SO supports

PRP PROTECTIONS

The cross connection, made up of the PMP multiple commoning bar and CPM screws and sleeves, already located in a position further back with respect to the front of the terminal board, can be further protected against accidental contacts, by means of a U-shaped cover, made of polyamide, with a standard length of 10 cm. The above protection, which is white, can also be used to write words or make reference markings of the terminal board. Special slots are provided on the protection to make it easy to remove using a screwdriver.

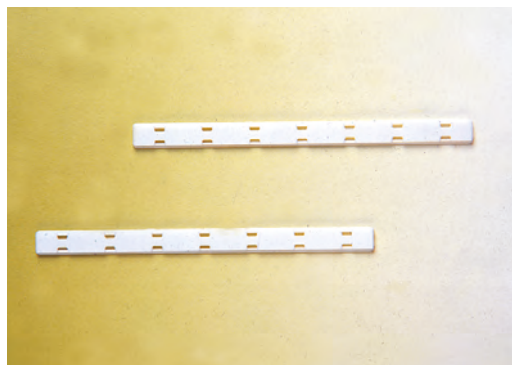

PRP Protections

for terminal blocks of cross section 2.5-4 mm ²	PRP/6	Cat. No. PRP06
for terminal blocks of cross section 4-16 mm ²	PRP/7	Cat. No. PRP07
for terminal blocks of cross section 25-70 mm ²	PRP/8	Cat. No. PRP08
for TLD.2-TLS.2-CBR.2-DAS.4-TLE.2-TDE.2 terminal blocks	PRP/5 (red, blue, white)	Cat. No. PRP05

Made of self-extinguishing material, capable of guarantee the maximum safety of work on terminal boards connected to circuits that are always live. Bearing warning signals and notices, fixable to the terminal blocks by means of two nylon insulating screws, they are available in models of different sizes, according to the type of terminal block. The cover can be tripolar or quadripolar; in some cases the tripolar is made removing a pre-cut part of the quadripolar cover. For CBC. 2-4-6-10 terminal blocks the PRP/7/G is supplied; this is without screws, to be inserted in the channels of the cross connections.



TERMINAL BLOCK	WARNING PLATE FOR 3 TERMINAL BLOCKS			WARNING PLATE FOR 4 TERMINAL BLOCKS			SCREW M X L (MM)
	TYPE	CODE	L X H MM	TYPE	CODE	L X H MM	
CBC.2	PRP/7/G	PRP070G	l = 100	PRP/7/G	PRP070G	100	-
CBC.4	PRP/7/G	PRP070G	l = 100	PRP/7/G	PRP070G	100	-
CBC.6	PRP/7/G	PRP070G	l = 100	PRP/7/G	PRP070G	100	-
CBC.10	PRP/7/G	PRP070G	l = 100	PRP/7/G	PRP070G	100	-
CBC.16	TUM/16	TUM16	48 x 34	TUM/16	TUM16	48 x 34	4 x 30
CBC.35	TUM/06	TUM06	63 x 34	TUM/06	TUM06	63 x 34	4 x 30
CBD.2	-	-	-	TQM/02	TQM02	25 x 26	2.5 x 20
CBD.4	TTM/12	TTM12	25 x 26	TTM/12	TTM12	25 x 26	3 x 25
CBD.6	TTM/15	TTM15	25 x 26	TQM/15	TQM15	32 x 26	3.5 x 25
CBD.10	TTM/04	TTM04	32 x 26	TQM/04	TQM04	40 x 26	4 x 25
CBD.16	TUM/05	TUM05	48 x 34	TUM/05	TUM05	48 x 34	4 x 25
CBD.35	TUM/06	TUM06	63 x 34	TUM/06	TUM06	63 x 34	4 x 30
CBD.50	TUM/07	TUM07	72 x 42	TUM/07	TUM07	72 x 42	5 x 30
CBD.70	TUM/08	TUM08	82 x 42	TUM/08	TUM08	82 x 42	5 x 40

[*] to be cut to size

TAI

Possible danger status may be marked using **special triangular self-adhesive labels**

TAI/6 (Cat. No. TA001)
TAI/12 (Cat. No. TA002)

to be applied on the protection covers and channels.



MSM HANDLE

For simultaneous switching of several FPL.10 and SFL.10 terminal blocks side-by-side. Supplied in strips of 6 elements.

MSM (Cat. No. FC103)

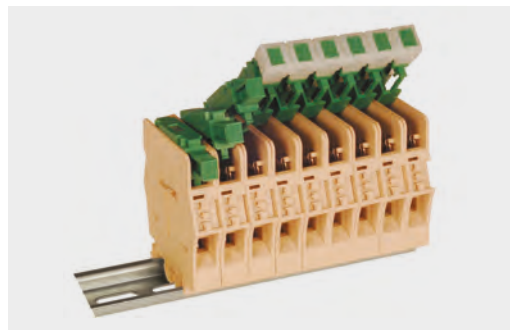

- Possibility of marking 2- and 3-level terminal blocks
- High visibility of the marking
- Available in the 2- and 3-tag version
- Reduced vertical size thanks to high flexibility
- Compatible with all the 2- and 3-level terminal blocks
- Available in grey



VERSION	CODE TYPE	TH02	TH03
		TH/2	TH/3
TECHNICAL CHARACTERISTICS			
function/type		tag holder	tag holder
vertical size	(mm)	19	21
width	(mm)	18	29
thickness	(mm)	4,7	4,7
Usable identification cards	Cabur Jet	C/NU/8/51 (cod. NU0851)	C/NU/8/51 (cod. NU0851)
		C/NU/8/61 (cod. NU0861)	C/NU/8/61 (cod. NU0861)
		C/NU/10/51 (cod. NU1051)	C/NU/10/51 (cod. NU1051)
		C/NU/10/61 (cod. NU1061)	C/NU/10/61 (cod. NU1061)
		C/NU/10/51 (cod. NU1055)	C/NU/10/51 (cod. NU1055)
	Smart Print	C/NU/10/65 (cod. NU1065)	C/NU/10/65 (cod. NU1065)
		C/NU/8/51 (cod. NU0851S)	C/NU/8/51 (cod. NU0851S)
		C/NU/10/51 (cod. NU1051S)	C/NU/10/51 (cod. NU1051S)
		C/NU/10/61 (cod. NU1061S)	C/NU/10/61 (cod. NU1061S)
		C/NU/10/61 (cod. NU1061S)	C/NU/10/61 (cod. NU1061S)
Quantity per pack	(pieces)	50	50

Screwdrivers to activate springs - terminal blocks Series: H
The ergonomic handle guarantees comfort for the entire duration of the work. In addition, each handle has a transparent anti-slip rubber insert, which ensures a good hold over the tool.

CODE	DIMENSIONS	LENGTH
CCH02	0.5 x 3 x 80 mm	160 mm
CCH06	1 x 5.5 x 125 mm	220 mm



CCH/2,5-4



CCH/6

Insulated screwdrivers for voltage up to 1,000 V
The ergonomic handle guarantees comfort for the entire duration of the work. In addition, each handle has a transparent anti-slip rubber insert, which ensures a good hold over the tool.

CODE	DIMENSIONS	LENGTH
CCV03	0.4 x 2.5 x 75 mm	160 mm
CCV04	0.8 x 4 x 100 mm	195 mm
CCV05	1 x 5.5 x 125 mm	220 mm



CCV/2,5



CCV/4



CCV/5

Terminals with sleeves and insulated collars

Series: WP

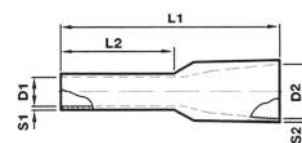

CODE	DESCRIPTION	COLOUR	SECTION	D1	D2	D3	L1	L2	S1	S2	PCS PCK.
			mm ²	mm	mm	mm	mm	mm	mm	mm	mm
WP30002	terminal blocks 0,5-14 x 8	White	0,5	1	2,6	-	14	8	0,15	0,25	500
WP30003	terminal blocks 0,5-16 x 10	White	0,5	1	2,6	-	16	10	0,15	0,25	500
WP30005	terminal blocks 0,75-14 x 8	Grey	0,75	1,2	2,8	-	14	8	0,15	0,25	500
WP30006	terminal blocks 0,75-16 x 10	Grey	0,75	1,2	2,8	-	16	10	0,15	0,25	500
WP30009	terminal blocks 1-14 x 8	Red	1	1,4	3	-	14	8	0,15	0,25	500
WP30010	terminal blocks 1-18 x 12	Red	1	1,4	3	-	18	12	0,15	0,25	500
WP30013	terminal blocks 1,5-14 x 8	Black	1,5	1,7	3,5	-	14	8	0,15	0,25	500
WP30014	terminal blocks 15-18 x 12	Black	1,5	1,7	3,5	-	18	12	0,15	0,25	500
WP30016	terminal blocks 2,5-14 x 8	Blue	2,5	2,2	4,2	-	15	8	0,15	0,25	500
WP30017	terminal blocks 25-19 x 12	Blue	2,5	2,2	4,2	-	19	12	0,15	0,25	500
WP30019	terminal blocks 4,0-16 x 8	Grey	4	2,8	4,8	-	16	8	0,2	0,3	500
WP30020	terminal blocks 40-20 x 12	Grey	4	2,8	4,8	-	20	12	0,2	0,3	500
WP30022	terminal blocks 6,0-20 x 12	Yellow	6	3,5	6,3	-	20	12	0,2	0,3	100
WP30023	terminal blocks 60-26 x 18	Yellow	6	3,5	6,3	-	26	18	0,2	0,3	100
WP30024	terminal blocks 10-22 x 12	Red	10	4,5	7,6	-	22	12	0,2	0,4	100
WP30025	terminal blocks 100-28 x 18	Red	10	4,5	7,6	-	28	18	0,2	0,4	100
WP30026	terminal blocks 16-22 x 12	Blue	16	5,8	8,8	-	22	12	0,2	0,4	100
WP30027	terminal blocks 160-28 x 18	Blue	16	5,8	8,8	-	28	18	0,2	0,4	100
WP30028	terminal blocks 25-30 x 16	Yellow	25	7,3	11,2	-	30	16	0,2	0,4	50
WP30029	terminal blocks 250-36 x 22	Yellow	25	7,3	11,2	-	36	22	0,2	0,4	50
WP30030	terminal blocks 35-30 x 16	Red	35	8,3	12,7	-	30	16	0,2	0,4	50
WP30031	terminal blocks 350-39 x 25	Red	35	8,3	12,7	-	39	25	0,2	0,4	50
WP30032	terminal blocks 50-36 x 20	Blue	50	10,3	15	-	36	20	0,3	0,5	50
WP30033	terminal blocks 500-41 x 25	Blue	50	10,3	15	-	41	25	0,3	0,5	50

Terminals with sleeves and insulated collars

Series: WP

The double slot series is made of tin-plated electrolytic copper with the insulated part in polypropylene, resistant up to 105°C.

These terminals were designed for use in connections where a quick and safe connection is required. In fact, the current trend towards miniaturisation of electrical equipment makes these terminals particularly useful and economical.

The special large housing slot is easily able to hold the bulk created by two wires.

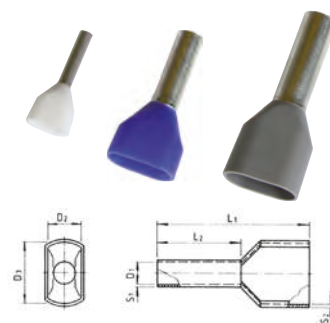

CODE	DESCRIPTION	COLOUR	SECTION	D1	D2	D3	L1	L2	S1	S2	PCS PCK.
			mm ²	mm	mm	mm	mm	mm	mm	mm	mm
WP90001	-	white	2,0 x 0,5	1,1,5	2,5	4,7	15,7	8,7	0,15	0,3	500
WP90002	-	grey	2,0 x 0,75	1,8	2,8	5	15,5	8,9	0,15	0,3	500
WP90003	-	red	2,0 x 1,0	2,3	3,2	5,5	15,8	8	0,15	0,3	500
WP90004	-	black	2,0 x 1,5	2,3	3,5	6,5	16	8	0,15	0,3	500
WP90005	-	blue	2,0 x 2,5	2,9	4,3	7,5	18,3	10	0,2	0,4	500
WP90006	-	grey	2,0 x 4,0	3,8	4,9	8,8	23,3	12,5	0,2	0,4	100
WP90007	-	yellow	2,0 x 6,0	-	-	-	-	12	-	-	100
WP90008	-	red	2,0 x 10	-	-	-	-	14	-	-	100

Terminals with uninsulated sleeves

Made of tin-plated electrolytic copper.



CODE	DESCRIPTION	SECTION	LENGTH	PCS PCK.
WPN10508	uninsulated terminal block 0.5-8	0.5	8	1000
WPN10758	uninsulated terminal block 0.75-8	0.75	8	1000
WPN11010	uninsulated terminal block 1-10	1	10	1000
WPN11510	uninsulated terminal block 1.5-10	1.5	10	1000
WPN12510	uninsulated terminal block 2.5-10	2.5	10	1000*
WPN14012	uninsulated terminal block 4.0-12	4	12	1000**
WPN16012	uninsulated terminal block 6.0-12	6	12	500
WPN11015	uninsulated terminal block 10-15	10	15	500
WPN11615	uninsulated terminal block 16-15	16	15	500
WPN12515	uninsulated terminal block 25-15	25	15	100
Nota1:	* appropriate for use with Cabur CBC.2 terminal blocks	-	-	-
Nota2:	** appropriate for use with Cabur CBC.4 terminal blocks	-	-	-

Blank lined area for notes.

Industrial Marking System (extract from full catalogue)

Code: SMARTPRINT - Marking: SMARTPRINT

The new printer with SmartPrint thermal transfer technology is Cabur's answer to the many different needs in the world of industrial marking.

Ideal for identifying terminal blocks, cables and electrical components, SmartPrint is characterised by its innovative design, developed to make it immediate, easy and intuitive to use.

Reliable, versatile, precise and fast, the high-resolution printing makes it possible to create long-lasting markings of excellent quality.

Fitted with a display, acoustic signal and two control keys, SmartPrint enables the printing of alphanumeric texts, logos and graphic symbols on numerous marking media:

- sleeve tags to identify wires
- adhesive cable marking labels
- tags for terminal blocks
- tags for push-buttons
- tags for contactors/PLCs;
- modular strips for electrical distribution panels
- panel identification tags.
- **MarKing Pro XT** management software

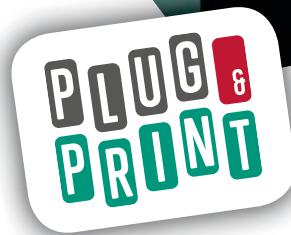

TECHNICAL DATA

Technology for	thermal transfer
Interface	USB 2.0
Resolution	300x600 dpi
Print Speed	Up to 19 mm/sec
Windows support	Microsoft® Windows™ 7 or later
Display	LCD
Dimensions [DxLxH]	400 x 230 x 280 mm
Weight	approx. 10 Kg.
Power supply voltage	100 - 240 VAC
Working temperature	15-34°C
Ribbon	monochromatic resin based
Ribbon colours	Black, Blue, Red, Green, White

THE PACKAGE INCLUDES:

- 1 SmartPrint printer
- 1 USB cable
- 1 Power cable
- 1 Power supply
- 1 Ribbon code RSP300BK
- 1 MarKing Pro XT Software, complete with user manual in electronic format
- 1 Plate Kit made up of:
 - 1 PLT06 support plate for cable tags code NUT12S/NUT18S;
 - 1 PLT01 support plate for FLAT series tags code NUT FL-TAP-TAV-TAM - TMM - SIM

Code: SMARTROLL - Marking: SMARTROLL

The SmartRoll thermal transfer printer is simple to use and guarantees rapid production of perfectly defined labels. Resistant, reliable and without the need for particular maintenance, SmartRoll is designed for high print volumes and is suited to any working environment. Precise in all details, it guarantees the lowest noise levels during use. Fitted with a display for controls and an acoustic signal, it is the ideal solution for continual and fast printing on:

- sleeve tags to identify wires
- adhesive cable-marking labels
- tags for contactors;
- **MarKing Pro XT** management software



TECHNICAL DATA

Technology for	thermal transfer
Interface	USB 2.0
Resolution	300 dpi
Print Speed	Up to 152 mm/sec
Windows support	Microsoft® Windows™ 7 or later
Dimensions (DxLxH)	505 x 270 x 308 mm
Weight	approx. 15 Kg.
Power supply voltage	100 - 240 VAC
Working temperature	5-40°C
Ribbon	monochromatic resin based
Ribbon colours	Black, Red

THE PACKAGE INCLUDES:

- 1 SmartRoll printer
- 1 USB cable
- 1 Power cable
- 1 MarKing Pro XT Software, complete with user manual in electronic format
- 1 Ribbon code RSR300BK

Code: CABURJET - ID code: CABURJET

The CaburJet inkjet printer has a smaller size to reduce bulk and offers an innovative design, aimed at making it fast and easy to use, with no maintenance problems.

It's the ideal solution for continuous, automatic, and fast printing of:

- sleeve tags to identify wires
- tags for terminal blocks;
- tags for push-buttons;
- tags for contactors;
- modular strips for electrical distribution panels
- panel identification tags.
- **MarKing Pro** management software

This is a highly innovative solution, created to meet multiple needs **in the industrial field**, at a competitive price.

The printer has an automatic integrated feeder (SEPARATOR), which accepts all of the above mentioned products - even mixed. It is also possible to print on individual stems by simply placing them at the bottom of the feeder like a normal sheet of paper.

The feeder can hold 50 cards for a total of 3,000 NUT12 series tags (tags for 12 mm long sleeves).

After just an hour of printing, 24,000 tags are ready for use. The material used (self-extinguishing polycarbonate) for production of the cards, together with the ink, means that the card can be used almost immediately after printing, and is indelible in accordance with CEI 16-7.



TECHNICAL DATA

Print technology	monochromatic inkjet printing
Interface	USB 2.0
Resolution	360 Dpi
Ink	refillable bottles
Print Speed	24,000 tags per hour
Windows support	for PC systems with Windows 98 SP2 and later
Dimensions (LxWxH)	330 x 370 x 220 mm
Weight	approx. 12 Kg.
Electricity consumption	during printing, 24W max. with compressor on, 35W
Power supply voltage	115-230V

THE PACKAGE INCLUDES:

- 1 CaburJet printer
- 1 USB cable
- 1 Power cable
- 2 80 ml bottle of ink
- 1 250 ml bottle of cleaner
- 1 copy of MarKing Pro software; including a licence for 5 installations, and a digital user manual



CNU/8/51 for HORIZONTAL and VERTICAL printing

- Marking tags suitable for marking all types of terminal blocks (screw-tightening and spring-clamp) in tables of 100 elements in packs of 500 tags
- In white polycarbonate with black printing, to be applied directly into position either before or after preparing the rail assembly.
- **Tag dimensions: 8 x 5.1 mm. Pitch on CBC.2 and HMM.2/GR.**
- **Mounting of single tag on all Cabur terminal blocks.**

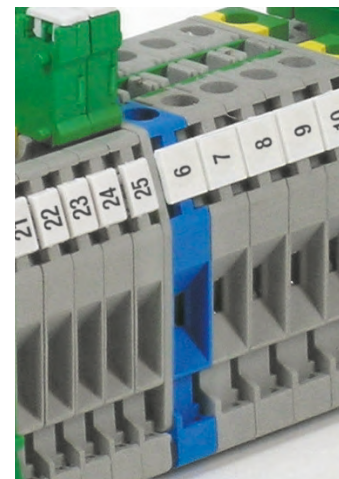

CODE FOR TAGS WITH VERTICAL NUMBERS	CODE FOR TAGS WITH HORIZONTAL NUMBERS	DESCRIPTION	CHARACTER	QUANTITY PK.
NU08515	NU08515	TAGS BLANK	-	1500
NU0851001V	NU0851001	TAG.NO. 1 to 50	1 - 50	500
NU0851010V	NU0851010	TAG.NO. 10	10	500
NU0851011V	NU0851011	TAG. NO. 11	11	500
NU0851012V	NU0851012	TAG. NO. 12	12	500
NU0851013V	NU0851013	TAG. NO. 13	13	500
NU0851014V	NU0851014	TAG. NO. 14	14	500
NU0851015V	NU0851015	TAG. NO. 15	15	500
NU0851016V	NU0851016	TAG. NO. 16	16	500
NU0851017V	NU0851017	TAG. NO. 17	17	500
NU0851018V	NU0851018	TAG. NO. 18	18	500
NU0851019V	NU0851019	TAG. NO. 19	19	500
NU0851020V	NU0851020	TAG. NO. 20	20	500
NU085102AV	NU085102A	TAGS. MARKED 2A	2A	500
NU0851051V	NU0851051	TAGS from 51 to 100	51 - 100	500
NU08510L1V	NU08510L1	TAGS. MARKED L1	L1	500
NU08510L2V	NU08510L2	TAGS. MARKED L2	L2	500
NU08510L3V	NU08510L3	TAGS. MARKED L3	L3	500
NU08510NIV	NU08510NI	TAGS. MARKED NI	NI	500
NU08510PEV	NU08510PE	TAGS. MARKED PE	PE	500
NU08510R1V	NU08510R1	TAGS. MARKED R1	R1	500
NU08510S1V	NU08510S1	TAGS. MARKED S1	S1	500
NU08510S2V	NU08510S2	TAGS. MARKED S2	S2	500
NU08510S3V	NU08510S3	TAGS. MARKED S3	S3	500
NU08510U1V	NU08510U1	TAGS. MARKED U1	U1	500
NU08510U2V	NU08510U2	TAGS. MARKED U2	U2	500
NU08510V	NU08510	TAGS NO. 0	0	500
NU08510V1V	NU08510V1	TAGS. MARKED V1	V1	500
NU08510V2V	NU08510V2	TAGS. MARKED V2	V2	500
NU08510W1V	NU08510W1	TAGS. MARKED W1	W1	500
NU08510W2V	NU08510W2	TAGS. MARKED W2	W2	500
NU0851101V	NU0851101	TAGS. from 101 to 150	101 - 105	500
NU085110V	NU085110	TAGS. MARKED =	=	500
NU085111V	NU085111	TAGS. MARKED +	+	500
NU085112V	NU085112	TAGS. MARKED -	-	500
NU085114V	NU085114	TAGS EARTH	⊕	500
NU0851151V	NU0851151	TAGS from 151 to 200	151 - 200	500
NU085115V	NU085115	TAG EARTH CIRCLE	⊕	500
NU08511V	NU08511	TAGS. NO. 1	1	500
NU0851201V	NU0851201	TAGS from 201 to 250	201 - 250	500
NU0851251V	NU0851251	TAGS from 251 to 300	251 - 300	500
NU08512V	NU08512	TAGS. NO. 2	2	500
NU0851301V	NU0851301	TAGS from 301 to 350	301 - 350	500
NU0851351V	NU0851351	TAGS from 351 to 400	351 - 400	500
NU08513V	NU08513	TAGS. NO. 3	3	500
NU0851401V	NU0851401	TAGS from 401 to 450	401 - 450	500
NU0851451V	NU0851451	TAGS from 451 to 500	451 - 500	500
NU08514V	NU08514	TAGS. NO 4	4	500
NU0851501V	NU0851501	TAGS from 501 to 550	501 - 550	500

Writing type

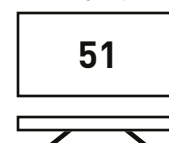

HORIZONTAL

Writing type

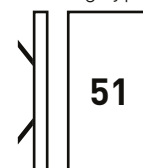

VERTICAL

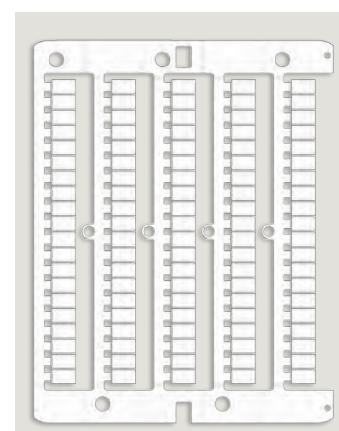

Card CNU/8/51
Code NU0851

CNU/8/51 for HORIZONTAL and VERTICAL printing

- Marking tags suitable for marking all types of terminal blocks (screw-tightening and spring-clamp) in tables of 100 elements in packs of 500 tags
- In white polycarbonate with black printing, to be applied directly into position either before or after preparing the rail assembly.
- **Tag dimensions: 8 x 5.1 mm. Pitch on CBC.2 and HMM.2/GR.**
- **Mounting of single tag on all Cabur terminal blocks.**

CODE FOR TAGS WITH VERTICAL NUMBERS	CODE FOR TAGS WITH HORIZONTAL NUMBERS	DESCRIPTION	CHARACTER	QUANTITY PK.
NU0851510V	NU0851510	TAGS from 1 to 10	1 - 10	500
NU0851520V	NU0851520	TAGS from 11 to 20	11 - 20	500
NU0851530V	NU0851530	TAGS from 21 to 30	21 - 30	500
NU0851540V	NU0851540	TAGS from 31 to 40	31 - 40	500
NU0851550V	NU0851550	TAGS from 41 to 50	41 - 50	500
NU0851551V	NU0851551	TAGS from 551 to 600	551 - 600	500
NU0851560V	NU0851560	TAGS from 51 to 60	51 - 60	500
NU0851570V	NU0851570	TAGS from 61 to 70	61 - 70	500
NU0851580V	NU0851580	TAGS from 71 to 80	71 - 80	500
NU0851590V	NU0851590	TAGS from 81 to 90	81 - 90	500
NU08515V	NU08515	TAGS. NO 5	5	500
NU0851600V	NU0851600	TAGS from 91 to 100	91 - 100	500
NU0851601V	NU0851601	TAGS from 601 to 650	601 - 650	500
NU0851651V	NU0851651	TAGS from 651 to 700	651 - 700	500
NU08516V	NU08516	TAGS. NO. 6	6	500
NU0851701V	NU0851701	TAGS from 701 to 750	701 - 750	500
NU0851751V	NU0851751	TAGS from 751 to 800	751 - 800	500
NU08517V	NU08517	TAGS. NO. 7	7	500
NU0851801V	NU0851801	TAGS from 801 to 850	801 - 850	500
NU0851851V	NU0851851	TAGS from 851 to 900	851 - 900	500
NU08518V	NU08518	TAGS. NO. 8	8	500
NU0851901V	NU0851901	TAGS from 901 to 950	901 - 950	500
NU0851951V	NU0851951	TAGS from 951 to 1,000	951 - 000	500
NU08519V	NU08519	TAGS. NO. 9	9	500
NU0851AV	NU0851A	TAGS A	A	500
NU0851BV	NU0851B	TAGS B	B	500
NU0851CV	NU0851C	TAGS C	C	500
NU0851DV	NU0851D	TAGS D	D	500
NU0851EV	NU0851E	TAGS E	E	500
NU0851FV	NU0851F	TAGS F	F	500
NU0851GV	NU0851G	TAGS G	G	500
NU0851HV	NU0851H	TAGS H	H	500
NU0851IV	NU0851I	TAGS I	I	500
NU0851JV	NU0851JV	TAGS J	J	500
NU0851KV	NU0851KV	TAGS K	K	500
NU0851LV	NU0851L	TAGS L	L	500
NU0851MV	NU0851M	TAGS M	M	500
NU0851NV	NU0851N	TAGS N	N	500
NU0851OV	NU0851O	TAGS O	O	500
NU0851PV	NU0851P	TAGS P	P	500
NU0851QV	NU0851Q	TAGS Q	Q	500
NU0851RV	NU0851R	TAGS R	R	500
NU0851SV	NU0851S	TAGS S	S	500
NU0851TV	NU0851T	TAGS T	T	500
NU0851UV	NU0851UV	TAGS U	U	500
NU0851VV	NU0851V	TAGS V	V	500
NU0851WV	NU0851W	TAGS W	W	500
NU0851XV	NU0851X	TAGS X	X	500
NU0851YV	NU0851Y	TAGS Y	Y	500
NU0851ZV	NU0851Z	TAGS Z	Z	500

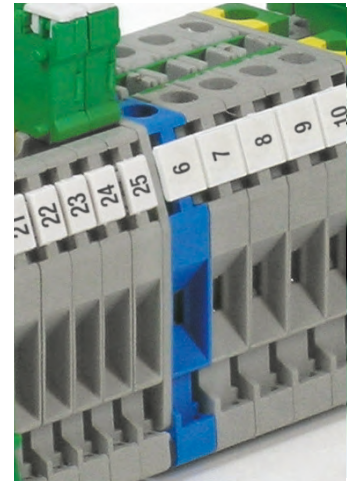

Writing type

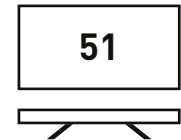

HORIZONTAL

Writing type

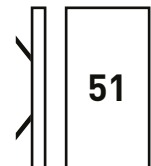

VERTICAL

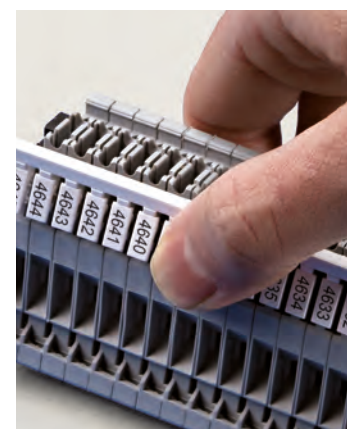

Mounting on Cabur terminal blocks.

Special numbering for terminal block marking

Cabur can supply, on request, special marking tags with numbers, letters, symbols and customised logos in packs of 500 tags, printed using the CaburJet System.

Request special marking by specifying the following on the order:

- A** - Item code, selected from those found in the table (e.g. NU0851SP)
- B** - Number of tags ordered (min. 500 pcs. / 1 pk.)
- C** - Writing type (horizontal or vertical)
- D** - Content (text, numbers, symbols) to be printed on the tags (e.g. A1B)

To optimise the service, as an alternative or in addition to that required at points c) and d), we recommend sending Cabur a Marking Pro file created with the specific requirements of the order.

For example, by ordering:

Code: NU0851SP
 Quantity: 1000
 Writing type: horizontal
 Content: ABC

You will receive 2 packs of 500 tags each of CNU/8/51, personalised as requested.

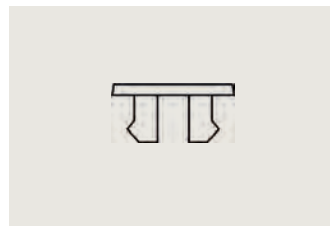
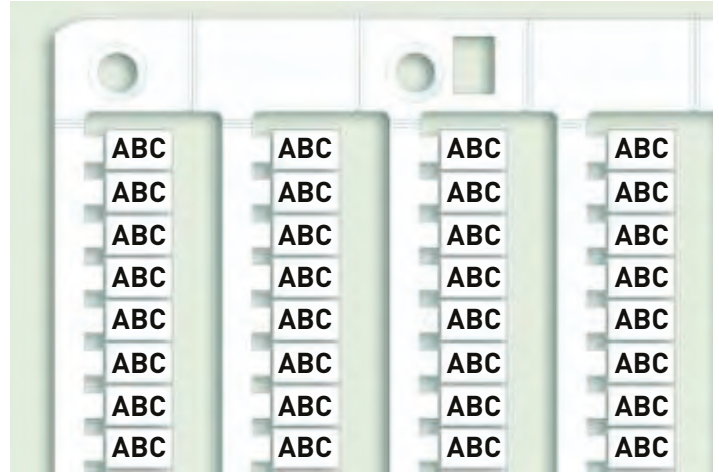

NU0800SP-NU0851SP-NU0861SP

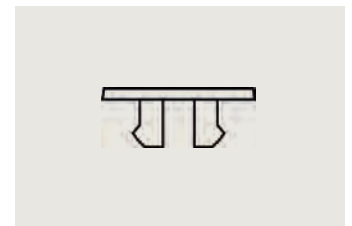

NU1051SP-NU1061SP-NU1055SP-NU1065SP

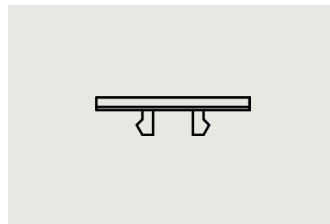

SH004SP

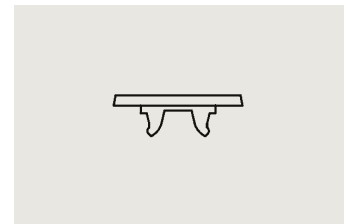

NUWDU50SP

SPECIAL NUMBERING		
CODE	ID CODE	DESCRIPTION
NU0800SP	NU0800SP	CNU/8/00 - special marking
NU0851SP	NU0851SP	CNU/8/51 - special marking
NU0861SP	NU0861SP	CNU/8/61 - special marking
NU1051SP	NU1051SP	CNU/10/51 - special marking
NU1061SP	NU1061SP	CNU/10/61 - special marking
SH004SP	SH004SP	SHZ.1 - special marking
SH004S	SH2.1	Blank tag spring-clamp terminal blocks sect 1.5 mm
SN008	SNZ/4/00	Blank strips
SN004SP	SNZ/4/SP	SN004SP - special numbering
NUWDU50SP	NUWDU50SP	NUWDU50 - special numbering
NUWDK50SP	NUWDK50SP	NUWDK50 - special numbering
NUPUTUK50SP	NUPUTUK50SP	NUPUTUK50 - special numbering
NUL1061SP	NUL1061	NUL1061 - special numbering
NU1055SP	NU1055SP	CNU/10/55 - special numbering
NU1065SP	NU1065SP	CNU/10/65 - special numbering
NUWG051SP	NUWG051SP	NUWG051SP - special numbering

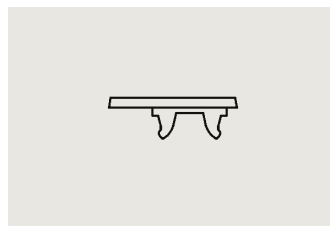

NUWDK50SP



NUPUTUK50S

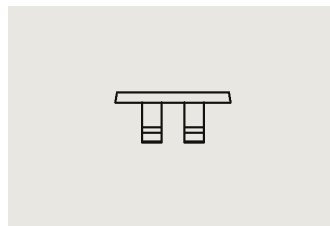

NUL1061SP



NUWG051SP

N.B. please contact our sales office for information about availability

Special numbering for wire marking

Cabur can supply, on request, special marking tags for wires, with numbers, letters, symbols and customised logos in packs of 500 tags, printed using the CaburJet System.

Request special numberings for wire marking, by specifying the following on the order:

- A** - Item code, selected from those found in the table (e.g. NUT15SP)
- B** - Number of tags ordered (min. 500 pcs. / 1 pk.)
- C** - Content (text, numbers, symbols) to be printed on the tags (e.g. A1B)

To optimise the service, as an alternative to or in addition to that required at point c), we recommend sending Cabur a MarKing Pro file created with the specific requirements of the order.

For example, by ordering:

Code: NUT15SP
 Quantity: 1500
 Content: ABC

An order will be placed for 3 packs of 500 tabs each of NUT15, customised as requested.

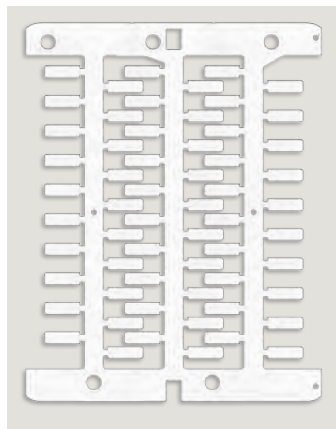
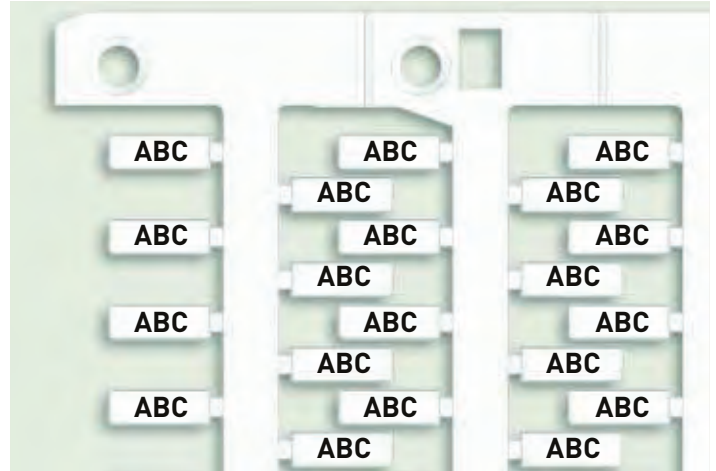

Mounting on Cabur terminal blocks

Writing type



HORIZONTAL

SPECIAL NUMBERING		
CODE	ID CODE	DESCRIPTION
NUT12SP	NUT12SP	NUT12SP - special numbering
NUT12YSP	NUT12YSP	NUT12YSP - special numbering
NUT15SP	NUT15SP	NUT15SP - special numbering
NUT15YSP	NUT15YSP	NUT15YSP - special numbering
NUT18SP	NUT18SP	NUT18SP - special numbering
NUT18YSP	NUT18YSP	NUT18YSP - special numbering
NUT23SP	NUT23SP	NUT23SP - special numbering
NUT23YSP	NUT23YSP	NUT23YSP - special numbering

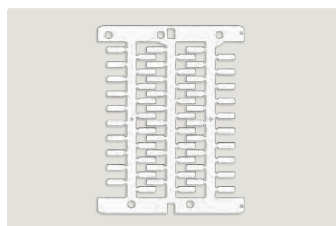

TAG CARD L. 12 mm
 NUWDK50SP

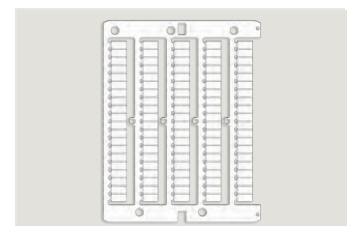

TAG CARD L. 15 mm
 NUPUTUK50S

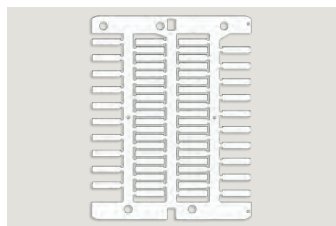

TAG CARD L. 18 mm

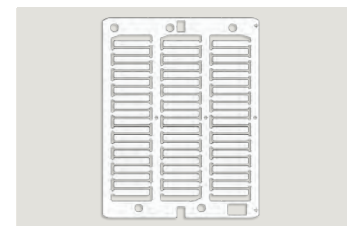

TAG CARD L. 23 mm

A

CODE	TYPE	QTY. per pk.	PAGE
AC100	ACB.70/BB	12	82
AC400	ACB.120/BB	12	82
AC700	ACB.185/BB	12	82
AF201	AF0/PT	50	148
AF400	AF0.2/2+2	100	123
AF500	AF0.2/1+1	100	123

B

BC100	BCA.70/BB	1	83
BC400	BCA.120/BB	1	83
BP100	BPL.4	60	131
BP200	BPL/R	100	131
BP300	BPL.4/PS	60	132
BT001	BT/DIN/PO	25	149
BT003	BT/3	25	149
BT005	BTU	25	149
BT006	BT/2	25	149
BT007	BTO	25	149

C

CAMT	CAMUT	10	141.1
CB009	CBD/SH	10	168
CB061GR	CBC.2-10/PT/GR	50	148
CB110	CBD.2	120	67
CB111	CB2/PT	50	148
CB161GR	CBC.16/PT/GR	25	148
CB240	CBD.4	100	67
CB241	CB4/6/PT	25	148
CB340	CBD.6	100	67
CB351GR	CBC.35/PT/GR	25	148
CB431	CB10/PT	25	148
CB440	CBD.10	100	68
CB510	CBD.16	50	68
CB511	CB16/PT	25	148
CB610	CBD.35	75	68
CB611	CB35/PT	25	148
CB710	CBD.50	50	69
CB710GR	CBD.50/GR	50	69
CB711	CB50/PT	10	148
CB810	CBD.70	40	69
CB810GR	CBD.70/GR	40	69
CB811	CB70/PT	10	148
CBC02GR	CBC.2/GR	120	55
CBC04GR	CBC.4/GR	100	55
CBC06GR	CBC.6/GR	100	55
CBC10GR	CBC.10/GR	100	56
CBC16GR	CBC.16/GR	50	56
CBC35GR	CBC.35/GR	50	56
CBF04GR	CBF.04/GR	50	97
CBF04I	CBF.4 (Ex)i	50	97
CBF423GR	CBF.4/C230/GR	50	103
CBF448GR	CBF.4/C48/GR	50	103

CODE	TYPE	QTY. per pk.	PAGE
CBI02	CBC.2 (EX)I	120	55
CBI04	CBC.4 (EX)I	100	55
CBI06	CBC.6 (EX)I	100	55
CBI061	CBC.2-10/PT(Ex)i	50	148
CBI10	CBC.10 (EX)I	100	56
CBI16	CBC.16 (EX)I	50	56
CBI161	CBC.16/PT(Ex)i	25	148
CBI35	CBC.35 (EX)I	50	56
CBI351	CBC.35/PT(Ex)i	25	148
CBS02	CBS.2	100	104
CBS02GR	CBS.2/GR	100	104
CBS02I	CBS.2 (Ex)i	100	104
CBS04	CBS.4	80	104
CBS04GR	CBS.4/GR	80	104
CBS04I	CBS.4 (Ex)i	80	104
CBX12	CBD.2 (EX)I	120	67
CBX13	CB2/PT (Ex)i	50	148
CBX24	CBD.4 (EX)I	100	67
CBX25	CB4/6/PT (Ex)i	25	148
CBX34	CBD.6 (EX)I	100	67
CBX44	CB10/PT (Ex)i	25	148
CBX45	CBD.10 (EX)I	100	68
CBX52	CBD.16 (EX)I	50	68
CBX53	CB16/PT (Ex)i	25	148
CBX62	CBD.35 (EX)I	75	68
CBX63	CB35/PT (Ex)i	25	148
CBX72	CBD.50 (EX)I	50	69
CBX73	CB50/PT (Ex)i	10	148
CBX82	CBD.70 (EX)I	40	69
CBX83	CB70/PT (Ex)i	10	148
CCH02	CCH/2.5-4	1	175
CCH06	CCH/6	1	175
CCV03	CCV/2.5	1	175
CCV04	CCV/4	1	175
CCV05	CCV/5	1	175
CE110	CBE.2	70	86
CF100	CF.12/1+1	50	133
CF200	CF.12/2+2	25	133
CF900	CF.12/CPT	40	133
CI110	CBR.2 (EX)I	75	57
CONT206	CONTC/2/6	20	143
CONT216	CONTC/2/16	20	143
CONT225	CONTC/2/25	10	143
CONT235	CONTC/2/35	5	143
CONT306	CONTC/3/6	10	143
CONT316	CONTC/3/16	5	143
CONT606	CONTC/6/6	5	143
CONT616	CONTC616	5	143

D

CODE	TYPE	QTY. per pk.	PAGE
CONTC01	CONT/1,5	10	144
CONTC02	CONT/2,5	10	144
CONTC04	CONTC/4	10	144
CONTC06	CONTC/6	10	144
CONTC10	CONTC/10	5	144
CONTC16	CONTC/16	5	144
CONTC25	CONTC/25	5	144
CPF05	CPF/5	20	167
CPFE02	CPFE/2		167
CPFE04	CPFE/4		167
CR110	CBR.2	75	57
CR110GR	CBR.2/GR	75	57
CR111	CBR/PT	25	148
CV100	CVF.4	100	124
CV100GR	CVF.4/GR	100	124
CV101	CVF/PT	25	148
CV101GR	CVF/PT/GR	25	148
CV201	CVF/PT (Ex)i	25	148
DA100	DSFA.4	100	101
DA100GR	DSFA.4/GR	100	101
DA200	DSF.4	80	100
DA200GR	DSF.4/GR	80	100
DB100	DBC.2	120	90
DB100GR	DBC.2/GR	120	90
DB101	DBC/PT	25	148
DB117	DBC.2/CI	120	90
DB117GR	DBC.2/CI/GR	120	90
DB200	DBC.2 (EX)I	120	90
DB201	DBC/PT(Ex)i	25	148
DB400GR	DBC.4GR	100	91
DB417GR	DBC.4/CI/GR	100	91
DB500	DBC.4(Ex)i	100	91
DB517	DBC.4/CI(Ex)i	100	91
DC005	SDC/5	25	165
DC006	SDC/6	25	165
DC05P	SDC/5P	25	165
DC06P	SDC/6P	25	165
DD001	SDD/1	50	166
DD002	SDD/2	50	166
DD005	SDD/5	25	165
DD006	SDD/6	25	165
DD501	SD5/PT	25	165
DD601	SD6/PT	25	165
DF300	DFM/300	50	171
DF400	DFM/400	50	171
DF500	DFM/500	50	171
DF600	DFM/600	50	171
DF700	DFM/700	50	171

CODE	TYPE	QTY. per pk.	PAGE
DF800	DFM/800	50	171
DF900	DFM/900	50	171
DFE01R	DFE.1+1/R	20	170
DFE02R	DFE.1+2/R	20	170
DFE03R	DFE.2+2/R	20	170
DFE04R	DFE.2P/R	20	170
DFP2R	DFP/2/R	50	170
DH004	SDH/4	25	165
DH005	SDH/5	25	165
DH006	SDH/6	25	165
DH007	SDH/7	25	165
DH01R	DFH/1/R	25	170
DH02R	DFH/2/R	25	170
DH03R	DFH/3/R	25	170
DH04R	DFH/4/R	25	170
DH401	SH4/PT	25	165
DH501	SH5/PT	25	165
DH601	SH6/PT	25	165
DH701	SH7/PT	25	165
DS100	DAS.4	120	92
DS100GR	DAS.4/GR	120	92
DS101	DAS/PT	25	148
DS107	DAS/VCI	25	168
DS108	DAS/VCE	25	168
DS110	DAS.4/SS	20	93
DS110GR	DAS.4/SS/GR	20	93
DS111	DAS.4/A	20	118
DS111GR	DAS.4/A/GR	20	118
DS112	DAS.4/B	20	118
DS112GR	DAS.4/B/GR	20	118
DS113	DAS.4/C	20	119
DS113GR	DAS.4/C/GR	20	119
DS114	DAS.4/D	20	119
DS114GR	DAS.4/D/GR	20	119
DS115	DAS.4/E	20	120
DS115GR	DAS.4/E/GR	20	120
DS117	DAS.4/CI	120	92
DS117GR	DAS.4/CI/GR	120	92
DS119	DAS.4/I	20	120
DS119GR	DAS.4/I/GR	20	120
DS120	DAS.4/DD	20	121
DS120GR	DAS.4/DD/GR	20	121
DS128	DAS.4/T	20	122
DS128GR	DAS.4/T/GR	20	122
DS129	DAS.4/U	20	122
DS129GR	DAS.4/U/GR	20	122
DS130	DAS.4/L	20	121
DS130GR	DAS.4/L/GR	20	121

CODE	TYPE	QTY. per pk.	PAGE
DS200	DAS.4 (EX)I	120	92
DS201	DAS/PT (Ex)i	25	148
DS217	DAS.4/CI (EX)I	120	92
DS301	DSS/PT	25	148
DS301GR	DSS/PT/GR	25	148
DS400	DSS.4	100	105
DS400	DSS.4	100	93
DS400GR	DSS.4/GR	100	93
DS400GR	DSS.4/GR	100	105
DS401GR	DFS.4/PT/GR	25	148
DSD005	DAS.4/D5	20	114
DSD005GR	DAS.4/D5/GR	20	114
DSD012	DAS.4/D12	20	114
DSD012GR	DAS.4/D12/GR	20	114
DSD024	DAS.4/D24	20	115
DSD024GR	DAS.4/D24/GR	20	115
DSD060	DAS.4/D60	20	115
DSD060GR	DAS.4/D60/GR	20	115
DSV024	DAS.4/V24	20	116
DSV024GR	DAS.4/V24/GR	20	116
DSV048	DAS.4/V48	20	116
DSV048GR	DAS.4/V48/GR	20	116
DSV120	DAS.4/V120	20	117
DSV120GR	DAS.4/V120/GR	20	117
DSV230	DAS.4/V230	20	117
DSV230GR	DAS.4/V230/GR	20	117
DU01R	DFU/1/R	50	170
DU02R	DFU/2/R	50	170
DU03R	DFU/3/R	50	170
DU04R	DFU/4/R	50	170
DU05R	DFU/5/R	50	170
DU06R	DFU/6/R	50	170
DU07R	DFU/7/R	50	170
EFB0202B	EFB.2/2/B	20	161
EFB0202R	EFB.2/2/R	20	161
EFB0203B	EFB.2/3/B	20	161
EFB0203R	EFB.2/3/R	20	161
EFB0205B	EFB.2/5/B	10	161
EFB0205R	EFB.2/5/R	10	161
EFB0210B	EFB.2/10/B	5	161
EFB0210R	EFB.2/10/R	5	161
EFB0402B	EFB.4/2/B	20	161
EFB0402R	EFB.4/2/R	20	161
EFB0403B	EFB.4/3/B	20	161
EFB0403R	EFB.4/3/R	20	161
EFB0405B	EFB.4/5/B	10	161
EFB0405R	EFB.4/5/R	10	161
EFB0410B	EFB.4/10/B	5	161

E

CODE	TYPE	QTY. per pk.	PAGE
EFB0410R	EFB.4/10/R	5	161
EFC200BL	EFC.2/BL	160	13
EFC200GR	EFC.2/GR	160	13
EFC201BL	EFC.2/PT/BL	25	148
EFC201GR	EFC.2/PT/GR	25	148
EFC210BL	EFC.2/1+2/BL	120	13
EFC210GR	EFC.2/1+2/GR	120	13
EFC211BL	EFC.2/1+2/PT/BL	25	148
EFC211GR	EFC.2/1+2/PT/GR	25	148
EFC220BL	EFC.2/2+2/BL	90	13
EFC220GR	EFC.2/2+2/GR	90	13
EFC221BL	EFC.2/2+2/PT/BL	25	148
EFC221GR	EFC.2/2+2/PT/GR	25	148
EFC400BL	EFC.4/BL	120	15
EFC400GR	EFC.4/GR	120	15
EFC401BL	EFC.4/PT/BL	25	148
EFC401GR	EFC.4/PT/GR	25	148
EFC410BL	EFC.4/1+2/BL	110	15
EFC410GR	EFC.4/1+2/GR	110	15
EFC411BL	EFC.4/1+2/PT/BL	25	148
EFC411GR	EFC.4/1+2/PT/GR	25	148
EFC420BL	EFC.4/2+2/BL	90	15
EFC420GR	EFC.4/2+2/GR	90	15
EFC421BL	EFC.4/2+2/PT/BL	25	148
EFC421GR	EFC.4/2+2/PT/GR	25	148
EFCE200	EFCE.2	80	14
EFCE210	EFCE.2/1+2	50	14
EFCE220	EFCE.2/2+2	60	14
EFCE400	EFCE.4	70	16
EFCE410	EFCE.4/1+2	60	16
EFCE420	EFCE.4/2+2	90	16
EFD200BL	EFD.2/BL	130	17
EFD200GR	EFD.2/GR	130	17
EFD201BL	EFD.2/PT/BL	25	148
EFD201GR	EFD.2/PT/GR	25	148
EFD210BL	EFD.2/CI/BL	30	17
EFD210GR	EFD.2/CI/GR	30	17
EFD220GR	EFD.2/E/GR	30	17
EFD400BL	EFD.4/BL	100	18
EFD400GR	EFD.4/GR	100	18
EFD401BL	EFD.4/PT/BL	25	148
EFD401GR	EFD.4/PT/GR	25	148
EFD410BL	EFD.4/CI/BL	40	18
EFD410GR	EFD.4/CI/GR	40	18
EFD420GR	EFD.4/E/GR	40	18
EFDE200	EFDE.2	30	19
EFDE400	EFDE.4	40	19
EFDS200GR	EFDS.2/GR	45	22

CODE	TYPE	QTY. per pk.	PAGE
EFDS201GR	EFDS.2/PT/GR	25	148
EFDS210GR	EFDS.2/1S/GR	45	22
EFDS220GR	EFDS.2/P/GR	45	22
EFF400BL	EFF.4/BL	35	23
EFF400GR	EFF.4/GR	35	23
EFF423GR	EFF.4/C230/GR	35	23
EFF448GR	EFF.4/C48/GR	35	23
EFS200BL	EFS.2/BL	75	20
EFS200GR	EFS.2/GR	75	20
EFS400BL	EFS.4/BL	70	20
EFS400GR	EFS.4/GR	70	20
EFT200BL	EFT.2/BL	100	21
EFT200GR	EFT.2/GR	100	21
EFT201BL	EFT.2/PT/BL	25	148
EFT201GR	EFT.2/PT/GR	25	148
EFT250GR	EFT.2/S/GR	100	21
EFT251GR	EFT.2/S/PT/GR	25	148
EFTE200	EFTE.2	35	21
FC102	SFC/CO	70	168
FD100	FDP.2	70	124
FD100GR	FDP.2/GR	70	124
FD101	FDP/PT	25	148
FD101GR	FDP/PT/GR	25	148
FF100	FFS.4	120	94
FF100GR	FFS.4/GR	120	94
FF101	FFS/PT	25	148
FF101GR	FFS/PT/GR	25	148
FJ402	FJ402	80	144.2
FJ403	FJ403	60	144.2
FJ404	FJ404	40	144.2
FL201	FL201	100	169
FL202	FL202	100	169
FN001ST	F5/100 mA	100	169
FN002ST	F5/200 mA	100	169
FN003ST	F5/315 mA	100	169
FN004ST	F5/500 mA	100	169
FN005ST	F5/630 mA	100	169
FN006ST	F5/1 A	100	169
FN007ST	F5/1.6 A	100	169
FN008ST	F5/2 A	100	169
FN009ST	F5/2.5 A	100	169
FN010ST	F5/3.15 A	100	169
FN011ST	F5/4 A	100	169
FN012ST	F5/5 A	100	169
FN013ST	F5/6.3 A	100	169
FN014ST	F5/8 A	100	169
FN015ST	F5/10 A	100	169
FN016ST	F5/12 A	100	169

G

CODE	TYPE	QTY. per pk.	PAGE
FP100	FPC.10	70	108
FP100	FPC.10	70	102
FP200	FPL.10/L	70	102
FP300	FPL.10/C	70	102
FP923	FPL.10/C230	70	103
FP948	FPL.10/C48	70	103
FV100	FVS.4	120	94
FV100GR	FVS.4/GR	120	94
FV101	FVS/PT	25	148
FV101GR	FVS/PT/GR	25	148
FV107	FVS/VCI	25	168
FV108	FVS/VCE	25	168
GA100	GPA.95	10	59
GA100GR	GPA.95/GR	10	59
GA110	GPA.95 (EX)I	10	59
GA200	GPA.150	8	60
GA200GR	GPA.150/GR	8	60
GA300	GPA.240	4	61
GA300GR	GPA.240/GR	4	61
GA400	GPA.70	25	58
GA400GR	GPA.70/GR	25	58
GA410	GPA.70 (EX)I	25	58
GF100	GPA.95/FIX	10	59
GF100GR	GPA.95/FIX/GR	10	59
GF200	GPA.150/FIX	8	60
GF200GR	GPA.150/FX/GR	8	60
GF300	GPA.240/FIX	4	61
GF300GR	GPA.240/FIX/GR	4	61
GF400	GPA.70/FIX	25	58
GF400GR	GPA.70/FIX/GR	25	58
GP100	GPM.95/BB	10	71
GP100GR	GPM.95/BB/GR	10	71
GP110	GPM.95/BB/FIX	10	71
GP110GR	GPM.95/BB/FIX/GR	10	71
GP120	GPM.95/O/BB	10	80
GP125	GPM.95/C/BB	10	80
GP130	GPM.95/O/BB/FIX	10	80
GP135	GPM.95/C/BB/FIX	10	80
GP200	GPM.95/BC	10	74
GP200GR	GPM.95/BC/GR	10	74
GP210	GPM.95/BC/FIX	10	74
GP210GR	GPM.95/BC/FIX/GR	10	74
GP300	GPM.95/CC	10	77
GP300GR	GPM.95/CC/GR	10	77
GP310	GPM.95/CC/FIX	10	77
GP310GR	GPM.95/CC/FIX/GR	10	77
GP400	GPM.150/BB	6	72
GP400GR	GPM.150/BB/GR	6	72

H

CODE	TYPE	QTY. per pk.	PAGE
GP410	GPM.150/BB/FIX	6	72
GP410GR	GPM.150/BB/FIX/GR	6	72
GP420	GPM.150/O/BB	6	80
GP425	GPM.150/C/BB	6	80
GP430	GPM.150/O/BB/FIX	6	81
GP435	GPM.150/C/BB/FIX	6	81
GP500	GPM.150/BC	6	75
GP500GR	GPM.150/BC/GR	5	75
GP510	GPM.150/BC/FIX	4	75
GP510GR	GPM.150/BC/FIX/GR	4	75
GP600	GPM.150/CC	6	78
GP600GR	GPM.150/CC/GR	6	78
GP610	GPM.150/CC/FIX	6	78
GP610GR	GPM.150/CC/FIX/GR	6	78
GP700	GPM.240/BB	4	73
GP700GR	GPM.240/BB/GR	4	73
GP710	GPM.240/BB/FIX	4	73
GP710GR	GPM.240/BB/FIX/GR	4	73
GP720	GPM.240/O/BB	4	81
GP725	GPM.240/C/BB	4	81
GP730	GPM.240/O/BB/FIX	4	81
GP735	GPM.240/C/BB/FIX	4	81
GP800	GPM.240/BC	4	76
GP800GR	GPM.240/BC/GR	4	76
GP810	GPM.240/BC/FIX	4	76
GP810GR	GPM.240/BC/FIX/GR	4	76
GP900	GPM.240/CC	4	79
GP900GR	GPM.240/CC/GR	4	79
GP910	GPM.240/CC/FIX	4	79
GP910GR	GPM.240/CC/FIX/GR	4	79
HB100GR	HSCB.4/GR	90	44
HB101GR	HSCB.4/PT/GR	25	148
HB200GR	HSCB.6/GR	60	44
HB201GR	HSCB.6/PT/GR	25	148
HB203	HSCB/6/PO/2	40	168
HB204	HSCB/6/PO/4	20	168
HB205	HSCB.6/CPM	40	168
HC200GR	HCD.1/GR	40	47
HC201GR	HCD.1/PT/GR	25	148
HC210	HCD.1 (EX)I	40	47
HD100GR	HMD.2/GR	60	39
HD101GR	HMD/PT/GR	25	148
HD120GR	HMD.1/CI/GR	50	37
HD130GR	HMD.1/X/GR	50	40
HD200GR	HMD.1/GR	50	37
HD201GR	HMD.1/PT/GR	25	148
HD300	HMD.1 (EX)I	50	37
HD301	HMD.1/PT(EX)i	25	148

CODE	TYPE	QTY. per pk.	PAGE
HD400GR	HMD.2N/GR	40	38
HD410	HMD.2N [EX]I	40	38
HD420GR	HMD.2N/DD/GR	40	41
HD430GR	HMD.2N/3DC/GR	40	41
HD440GR	HMD.2N/X/GR	40	40
HD441GR	HMD.2N/X1/GR	40	40
HD450GR	HMD.2N/CI/GR	40	38
HD510	HLD.2 [EX]I	50	42
HF111GR	HMF/PT/GR	25	148
HF210GR	HFR.4/GR	70	46
HF211GR	HFR.4/PT/GR	25	148
HF300GR	HMFA.2/GR	80	45
HF310GR	HFR.4/M/GR	100	46
HI130	HP.2 [EX]I	100	50
HI131	HPC.2 [EX]I	100	51
HI132	HPP.2 [EX]I	100	50
HI210	HMM.4/1+2 [EX]I	40	30
HI220	HMM.4/2+2 [EX]I	20	30
HI250	HMM.4 [EX]I	60	30
HI251	HMT.4/PT [Ex]i	25	148
HI320	HMM.6 [EX]I	30	31
HI321	HMT.6/PT [Ex]i	25	148
HI330	HMM.10 [EX]I	30	31
HI340	HMM.16 [EX]I	30	31
HI400	HMM.1 [EX]I	100	27
HI401	HMT.1/PT [Ex]i	25	148
HI410	HMM.1/1+2 [EX]I	80	27
HI411	HMT.1/1+2/PT[Ex]i	25	148
HI420	HMM.1/2+2 [EX]I	60	27
HI421	HMT.1/2+2/PT[Ex]i	25	148
HI500	HMM.2 [EX]I	80	28
HI501	HMT.2/PT [Ex]i	25	148
HI510	HMM.2/1+2 [EX]I	80	28
HI511	HMT.2/1+2/PT[Ex]i	25	148
HI520	HMM.2/2+2 [EX]I	60	28
HI521	HMT.2/2+2/PT[Ex]i	25	148
HL200GR	HLD.2/GR	50	42
HL201GR	HLD.2/PT/GR	25	148
HL210GR	HLD.2/CI/GR	50	42
HL500GR	HDE.2/GR	50	42
HLT500	HTTE.2	50	43
HM170GR	HMM.2/2+2/A/GR	60	29
HM210GR	HMM.4/1+2/GR	40	30
HM220GR	HMM.4/2+2/GR	40	30
HM250GR	HMM.4/GR	60	30
HM251GR	HMT.4/PT/GR	25	148
HM320GR	HMM.6/GR	30	31
HM321GR	HMT.6/PT/GR	25	148

CODE	TYPE	QTY. per pk.	PAGE
HM330GR	HMM.10/GR	30	31
HM340GR	HMM.16/GR	30	31
HM350GR	HMR.16/GR	15	32
HM360GR	HMR.16/D/GR	30	32
HM400GR	HMM.1/GR	100	27
HM401GR	HMT.1/PT/GR	25	148
HM410GR	HMM.1/1+2/GR	80	27
HM411GR	HMT.1/1+2/PT	25	148
HM420GR	HMM.1/2+2/GR	60	27
HM421GR	HMT.1/2+2/PT	25	148
HM500GR	HMM.2/GR	80	28
HM501GR	HMT.2/PT/GR	25	148
HM510GR	HMM.2/1+2/GR	80	28
HM511GR	HMT.2/1+2/PT/GR	25	148
HM520GR	HMM.2/2+2/GR	60	28
HM521GR	HMT.2/2+2/PT/GR	25	148
HMS10GR	HMM.2/2+2/S/GR	60	29
HMS20GR	HMM.2/1+2/S/GR	80	29
HP101GR	HP/PT/GR	25	148
HP150GR	HP.2/GR	100	50
HP160GR	HPC.2/GR	100	51
HP170GR	HPP.2/GR	100	50
HS200GR	HMS.2/GR	80	44
HT250	HTE.4	60	35
HT260	HTE.4/1+2	40	35
HT270	HTE.4/2+2	20	35
HT320	HTE.6	30	36
HT330	HTE.10	30	36
HT340	HTE.16	30	36
HT400	HTE.1	80	33
HT410	HTE.1/1+2	80	33
HT420	HTE.1/2+2	60	33
HT500	HTE.2	80	34
HT510	HTE.2/1+2	80	34
HT520	HTE.2/2+2	60	34
HV111GR	HPV/PT/GR	25	148
HVP300GR	HVPC.2/GR	120	48
HVP305	HVPC.2 [EX]I	120	48
HVP900GR	CHP.2/GR	20	48
HVP905	CHP.2 [EX]I	20	48
HVP910GR	CHP.2D/GR	20	48
HVP915	CHP.2D [EX]I	20	48
HVT500	HVTE.2	80	49
HVT900	CHTE.2	20	49
HVT910	CHTE.2D	20	49
KIT1224	KITLSN/12-24	1	169
KIT70380	KITLSN/70-380	50	169
MA100	MAC.6	80	128

CODE	TYPE	QTY. per pk.	PAGE
MA110	CAM	100	128
MB100	MBL.50/6	10	84
MB200	MBL.95/8	10	84
MB300	MBL.120/10	10	85
MB400	MBL.150/12	10	85
MF100	MPFA.4	100	101
MF100GR	MPFA.4/GR	100	101
MP121	MPS.2/PT	25	148
MP121GR	MPS.2/PT/GR	25	148
MP131	MPS.2/PT[EX]i	25	148
MP901	MPS.4/PT	25	148
MP901GR	MPS.4/PT/GR	25	148
MP902	MPS.4/PT[EX]i	25	148
MP950	MPS.4	100	105
MP950GR	MPS.4/GR	100	105
MP960	MPS.4/SW [EX]I	100	105
MZ300N	MS/8X10/N	1	136
MZ300T	MS/8X10/T	1	136
NU0800SP	NU0800SP	500	185
NU0851510V	NU0851510	500	184
NU0851520V	NU0851520	500	184
NU0851530V	NU0851530	500	184
NU0851540V	NU0851540	500	184
NU0851550V	NU0851550	500	184
NU0851551V	NU0851551	500	184
NU0851560V	NU0851560	500	184
NU0851570V	NU0851570	500	184
NU0851580V	NU0851580	500	184
NU0851590V	NU0851590	500	184
NU08515V	NU08515	500	184
NU0851600V	NU0851600	500	184
NU0851601V	NU0851601	500	184
NU0851651V	NU0851651	500	184
NU08516V	NU08516	500	184
NU0851701V	NU0851701	500	184
NU0851751V	NU0851751	500	184
NU08517V	NU08517	500	184
NU0851801V	NU0851801	500	184
NU0851851V	NU0851851	500	184
NU08518V	NU08518	500	184
NU0851901V	NU0851901	500	184
NU0851951V	NU0851951	500	184
NU08519V	NU08519	500	184
NU0851AV	NU0851A	500	184
NU0851BV	NU0851B	500	184
NU0851CV	NU0851C	500	184
NU0851DV	NU0851D	500	184
NU0851EV	NU0851E	500	184

K

M

CODE	TYPE	QTY. per pk.	PAGE
NU0851FV	NU0851F	500	184
NU0851GV	NU0851G	500	184
NU0851HV	NU0851H	500	184
NU0851IV	NU0851I	500	184
NU0851JV	NU0851J	500	184
NU0851KV	NU0851K	500	184
NU0851LV	NU0851L	500	184
NU0851MV	NU0851M	500	184
NU0851NV	NU0851N	500	184
NU0851OV	NU0851O	500	184
NU0851PV	NU0851P	500	184
NU0851QV	NU0851Q	500	184
NU0851RV	NU0851R	500	184
NU0851SP	NU0851SP	500	185
NU0851SV	NU0851S	500	184
NU0851TV	NU0851T	500	184
NU0851UV	NU0851U	500	184
NU0851VW	NU0851V	500	184
NU0851WV	NU0851W	500	184
NU0851XV	NU0851X	500	184
NU0851YV	NU0851Y	500	184
NU0851ZV	NU0851Z	500	184
NU0861SP	NU0861SP	400	185
NU1051SP	NU1051SP	500	185
NU1055SP	NU1055SP	450	185
NU1061SP	NU1061SP	400	185
NU1065SP	NU1065SP	400	185
NUL1061SP	NUL1061		185
NUPUTUK50SP	NUPUTUK50SP		185
NUT12SP	NUT12SP	300	186
NUT12YSP	NUT12YSP		186
NUT15SP	NUT15SP	400	186
NUT15YSP	NUT15YSP		186
NUT18SP	NUT18SP		186
NUT18YSP	NUT18YSP		186
NUT23SP	NUT23SP		186
NUT23YSP	NUT23YSP		186
NUWDK50SP	NUWDK50SP		185
NUWDU50SP	NUWDU50SP	500	185
NUWG051SP	NUWG051SP		185
PD001	PSD/A	50	166
PD002	PSD/B	50	166
PD003	PSD/C	50	166
PD004	PSD/D	50	166
PD009	PSD/L	50	166
PD011	PSD/K	50	166
PD013	PSD/N	50	166
PD014	PSD/J	50	166

CODE	TYPE	QTY. per pk.	PAGE
PD015	PSD/P	50	166
PD017	PSD/O	50	166
PF100	PDF.2	75	125
PF100GR	PDF.2/GR	75	124
PF101	PDF/PT	25	148
PIL02	PIL/2	15	156
PIL03	PIL/3	15	156
PIL04	PIL/4	15	156
PIL08	PIL/8	10	156
PM100	PM/10/10	10	156
PM102	PM/10/2	25	156
PM103	PM/10/3	25	156
PM105	PM/10/5	25	156
PM110	PM/11/10	10	156
PM112	PM/11/2	25	156
PM113	PM/11/3	25	156
PM115	PM/11/5	25	156
PM120	PM/12/10	10	156
PM122	PM/12/2	25	156
PM123	PM/12/3	25	156
PM125	PM/12/5	25	156
PM202	PM/20/2	25	156
PM203	PM/20/3	25	156
PM205	PM/20/5	25	156
PM210	PM/20/10	10	156
PM250	PM/25/10	10	156
PM252	PM/25/2	25	156
PM253	PM/25/3	25	156
PM255	PM/25/5	25	156
PM303	PM/30/3	25	156
PM305	PM/30/5	25	156
PM310	PM/30/10	10	156
PM400	PM/40/10	10	156
PM402	PM/40/2	25	156
PM403	PM/40/3	25	156
PM405	PM/40/5	25	156
PM410	PM/41/10	10	156
PM412	PM/41/2	25	156
PM413	PM/41/3	25	156
PM415	PM/41/5	25	156
PM510	PM/51/10	10	156
PM513	PM/51/3	25	156
PM515	PM/51/5	25	156
PM602	PM/60/2	25	156
PM603	PM/60/3	25	156
PM605	PM/60/5	25	156
PM610	PM/60/10	10	156
PMP01	PMP/01	8	163

CODE	TYPE	QTY. per pk.	PAGE
PMP02	PMP/02	8	163
PMP04	PMP/04	8	163
PMP05	PMP/05	8	163
PMP06	PMP/06	8	163
PMP07	PMP/07	8	163
PMP08	PMP/08	8	163
PMP13	PMP/13	8	163
PMP16	PMP/16	8	163
PMP17	PMP/17	8	163
PMP25	PMP/25	8	163
PMP35	PMP/35	8	163
PMP42	PMP/42	8	163
PMP56	PMP/56	8	163
PMP58	PMP/58	8	163
PO152	POF/150/2	10	162
PO153	POF/150/3	10	162
PO242	POF/240/2	10	162
PO243	POF/240/3	10	162
PO952	POF/95/2	10	162
PO953	POF/95/3	10	162
POF06	POF/06	15	162
POF07	POF/07	15	162
POF08	POF/08	15	162
POF11	POF/11	25	162
POF12	POF/12	25	162
POF13	POF/13	25	162
POF14	POF/14	25	162
POF17	POF/17	25	162
POF20	POF/20	25	162
POF35	POF/35	15	162
POF44	POF/44	25	162
POF53	POF/53	25	162
POF54	POF/54	25	162
POF55	POF/55	25	162
POF56	POF/56	25	162
POF57	POF/57	25	162
POF70	POF/70	25	162
POF99	POF/99	25	162
POS08	POS/08	15	164
POS11	POS/11	25	164
POS41	POS/41	25	164
POS42	POS/42	25	164
POS43	POS/43	25	164
POS44	POS/44	25	164
POS53	POS/53	15	164
POS66	POS/66	25	164
POS72	POS/72	25	164
POS77	POS/77	25	164

P

CODE	TYPE	QTY. per pk.	PAGE
POS93	POS/93	25	164
PR001	PR/DIN/AC	20	151
PR002	PR/DIN/AL	20	151
PR003	PR/3/AC	40	151
PR004	PR/DIN/AS	20	151
PR005	PR/3/AS	40	151
PR006	PR/3/PA	20	151
PR007	PR/3/PP	20	151
PR009	PR/2/AC	100	151
PR010	PR/2/AS	100	151
PR901	PR/DIN/AC/ZB	20	151
PR903	PR/3/AC/ZB	40	151
PR904	PR/DIN/AS/ZB	20	151
PR905	PR/3/AS/ZB	40	151
PR906	PR/3/PA/ZB	20	151
PR907	PR/3/PP/ZB	20	151
PR909	PR/2/AC/ZB	100	151
PR910	PR/2/AS/ZB	100	151
PRP070G	PRP/7/G	10	173
PTC0100	PTC/1/00	8	157
PTC0102	PTC/1/02	25	157
PTC0103	PTC/1/03	25	157
PTC0105	PTC/1/05	25	157
PTC0110	PTC/1/10	10	157
PTC0200	PTC/2/00	8	157
PTC0202	PTC/2/02	25	157
PTC0203	PTC/2/03	25	157
PTC0205	PTC/2/05	25	157
PTC0210	PTC/2/10	10	157
PTC0300	PTC/3/00	8	157
PTC0302	PTC/3/02	25	157
PTC0303	PTC/3/03	25	157
PTC0305	PTC/3/05	25	157
PTC0310	PTC/3/10	10	157
PTC0400	PTC/4/00	8	157
PTC0402	PTC/4/02	25	157
PTC0403	PTC/4/03	25	157
PTC0405	PTC/4/05	25	157
PTC0410	PTC/4/10	10	157
PTC0500	PTC/5/00	8	157
PTC0502	PTC/5/02	25	157
PTC0503	PTC/5/03	25	157
PTC0505	PTC/5/05	25	157
PTC0510	PTC/5/10	10	157
PTC0600	PTC/6/00	8	157
PTC0602	PTC/6/02	25	157
PTC0603	PTC/6/03	25	157
PTC0605	PTC/6/05	25	157

CODE	TYPE	QTY. per pk.	PAGE
PTC0610	PTC/6/10	10	157
PTC0800	PTC/8/00	8	157
PTC0802	PTC/8/02	25	157
PTC0803	PTC/8/03	25	157
PTC0805	PTC/8/05	25	157
PTC0810	PTC/8/10	10	157
PTC1000	PTC/10/00	8	157
PTC1002	PTC/10/02	25	157
PTC1003	PTC/10/03	25	157
PTC1005	PTC/10/05	25	157
PTC1010	PTC/10/10	10	157
PTC1100	PTC/11/00	8	157
PTC1102	PTC/11/02	25	157
PTC1103	PTC/11/03	25	157
PTC1105	PTC/11/05	25	157
PTC1110	PTC/11/10	10	157
PTC1600	PTC/16/00	8	157
PTC1602	PTC/16/02	25	157
PTC1603	PTC/16/03	25	157
PTC1605	PTC/16/05	25	157
PTC1610	PTC/16/10	10	157
PTC2000	PTC/20/00	8	157
PTC2002	PTC/20/02	25	157
PTC2003	PTC/20/03	25	157
PTC2005	PTC/20/05	25	157
PTC2010	PTC/20/10	10	157
PTM	PTM	15	150
PTMS	PTMS	36	150
PTP0202B	PTP/2/02/B	25	159
PTP0202R	PTP/2/02/R	25	159
PTP0203B	PTP/2/03/B	25	159
PTP0203R	PTP/2/03/R	25	159
PTP0205B	PTP/2/05/B	25	159
PTP0205R	PTP/2/05/R	25	159
PTP0210B	PTP/2/10/B	25	159
PTP0210R	PTP/2/10/R	25	159
PTP0230B	PTP/2/30/B	25	159
PTP0230R	PTP/2/30/R	25	159
PTP0302B	PTP/3/02/B	25	159
PTP0302R	PTP/3/02/R	25	159
PTP0303B	PTP/3/03/B	25	159
PTP0303R	PTP/3/03/R	25	159
PTP0305B	PTP/3/05/B	25	159
PTP0305R	PTP/3/05/R	25	159
PTP0310B	PTP/3/10/B	25	159
PTP0310R	PTP/3/10/R	25	159
PTP0330B	PTP/3/30/B	25	159
PTP0330R	PTP/3/30/R	25	159

CODE	TYPE	QTY. per pk.	PAGE
PTP0402B	PTP/4/02/B	25	159
PTP0402R	PTP/4/02/R	25	159
PTP0403B	PTP/4/03/B	25	159
PTP0403R	PTP/4/03/R	25	159
PTP0405B	PTP/4/05/B	25	159
PTP0405R	PTP/4/05/R	25	159
PTP0410B	PTP/4/10/B	25	159
PTP0410R	PTP/4/10/R	25	159
PTP0430B	PTP/4/30/B	25	159
PTP0430R	PTP/4/30/R	25	159
PTP0502B	PTP/5/02/B	25	159
PTP0502R	PTP/5/02/R	25	159
PTP0503B	PTP/5/03/B	25	159
PTP0503R	PTP/5/03/R	25	159
PTP0505B	PTP/5/05/B	25	159
PTP0505R	PTP/5/05/R	25	159
PTP0510B	PTP/5/10/B	25	159
PTP0510R	PTP/5/10/R	25	159
PTP0530B	PTP/5/30/B	25	159
PTP0530R	PTP/5/30/R	25	159
QBLOK1201	QBLOK.12/BLU	10	137
QBLOK1202	QBLOK.12/TE	10	137
QBLOK1203	QBLOK.12/GR	10	137
QBLOK1P160	QBLOK1P160A6	1	138
QBLOK1P250	QBLOK1P250A10	1	138
QBLOK1P400	QBLOK1P400A10	1	138
QBLOK2100	QBLOK2P100A7	4	139
QBLOK2125	QBLOK2P125A11	2	139
QBLOK2126	QBLOK2P125A15	2	139
QBLOK4100	QBLOK4P100A7	2	140
QBLOK4125	QBLOK4P125A11	1	140
QBLOK4126	QBLOK4P125A15	1	140
QBLOK4160S	QBLOK4P160A9	1	141
QBLOK4161N	QBLOK4P160A14	1	141
QBLOK7001	QBLOK.7/BLU	10	137
QBLOK7002	QBLOK.7/TE	10	137
QBLOK7003	QBLOK.7/GR	10	137
QPOL1203	POLM.1215	10	142
QPOL1204	POLM.1215/TE	10	142
QPOL1205	POLM.1215/BLU	10	142
RF101GR	RFN/PT/GR	25	148
RF201	RFN/PT[Ex]i	25	148
RN300GR	RN.1/GR	125	129
RN400	RN.1 [EX]I	125	129
RN500GR	RN.2/GR	110	129
RN510	RN.2 [EX]I	110	129
RP300GR	RP.4/GR	200	129
RP301GR	RP.4/PT/GR	25	148

S

CODE	TYPE	QTY. per pk.	PAGE
RP400	RP.4 [EX]I	200	129
RP401	RP.4/PT[Ex]i	25	148
SB200	SCB.6	100	110
SB200GR	SCB.6/GR	100	110
SB201	SCB.6/PT	25	148
SB201GR	SCB.6/PT/GR	25	148
SB203	SCB.6/PO/2	40	168
SB204	SCB.6/PO/4	20	168
SB205	SCB.6/CPM	25	168
SB210	SCB.6/DD	80	110
SB210GR	SCB.6/DD/GR	80	110
SB220	SCB.6/CD	80	110
SB220GR	SCB.6/CD/GR	80	110
SB300	SCB.4	75	108
SB300GR	SCB.4/GR	75	108
SB301	SCB.4/PT	25	148
SB301GR	SCB.4/PT/GR	25	148
SB303	SCB.4/PO/2	40	168
SB304	SCB.4/PO/4	20	168
SB305	SCB.4/CPM	25	168
SB400	SCB.10	80	111
SB400GR	SCB.10/GR	80	111
SB401	SCB.10/PT	25	148
SB401GR	SCB.10/P/GR	25	148
SB410	SCB.10/DD	80	111
SB410GR	SCB.10/DD/GR	80	111
SB420	SCB.10/CD	80	111
SB420GR	SCB.10/CD/GR	80	111
SC103	SCX/PO/2	40	168
SC104	SCX/PO/4	20	168
SC105	SCX/CPM	40	168
SF401	SFO/PT	25	148
SF401GR	SFO/PT/GR	25	148
SF510	CIL/115-230	10	169
SF518	CIL/12-48	10	169
SF601	SFO/PT [Ex]i	25	148
SF701	SFR/PT	25	148
SF801	SFR/PT [Ex]i	25	148
SF850	SFR.4 [EX]I	70	106
SF850	SFR.4 [EX]I	70	97
SF900	SFR.4	70	112
SF900	SFR.4	70	106
SF900	SFR.4	70	97
SF900GR	SFR.4/GR	70	97
SF900GR	SFR.4/GR	70	106
SF900GR	SFR.4/GR	70	112
SF901GR	SFR.4/D1/GR	70	112
SF903GR	SFR.4/D3/GR	70	112

T

CODE	TYPE	QTY. per pk.	PAGE
SF910	SFR.4/VS	50	106
SF910	SFR.4/VS	50	99
SF910GR	SFR.4/VS/GR	50	106
SF910GR	SFR.4/VS/GR	50	99
SF923	SFR.4/C230	70	103
SF923GR	SFR.4/C230/GR	70	103
SF948	SFR.4/C48	70	103
SF948GR	SFR.4/C48/GR	70	103
SFR901	SFR.4/D1	70	112
SFR903	SFR.4/D3	70	112
SH004S	SH2.1	1500	185
SH004SP	SH004SP	500	185
SN004SP	SNZ/4/SP	60	185
SN008	SNZ/4/00	60	185
SR300	SFR.6	50	107
SR300	SFR.6	50	98
SR300GR	SFR.6/GR	50	98
SR300GR	SFR.6/GR	50	107
SR301	SFR.6/PT	25	148
SR400	SFR.6 [EX]I	50	107
SR400	SFR.6 [EX]I	50	98
SR401	SFR.6/PT[Ex]i	25	148
SR500	SFR.6/M	50	107
SR500	SFR.6/M	50	98
SR500GR	SFR.6/M/GR	50	98
SR500GR	SFR.6/M/GR	50	107
SR600	SFR.6/M [EX]I	50	98
SR600	SFR.6/M [EX]I	50	107
TC500	TC/PO	125	127
TC500GR	TC/PO/GR	125	127
TC510	TC/PO [EX]I	125	127
TE110	TE.6/D	50	88
TE210	TE.16/D	30	89
TE310	TE.50/D	15	89
TE400	TED.4	65	87
TE500	TE.10/D	35	89
TH02	TH/2	50	174
TH03	TH/3	50	174
TL100	TLS.2	200	95
TL100GR	TLS.2/GR	200	95
TL101	TLS/PT	25	148
TL200	TLD.2	125	96
TL200GR	TLD.2/GR	125	96
TL201	TLD/PT	25	148
TL201GR	TLS/PT/GR	25	148
TL300	TLD.2 [EX]I	125	96
TL301	TLD/PT [Ex]i	25	148
TL400	TLE.2	200	96

V

CODE	TYPE	QTY. per pk.	PAGE
TL400GR	TLE.2/GR	200	96
TL500	TDE.2	125	96
TL500GR	TDE.2/GR	125	96
TO110	TE.6/0	45	87
TO120	TEC.6/0	45	62
TO210	TE.16/0	30	88
TO220	TEC.16/0	30	62
TO310	TE.50/0	15	88
TO320	TEC.35/0	15	63
TO430	TE0.4	50	86
TO431	TE0.4/PT	25	148
TO500	TE.10/0	35	87
TO510	TEC.10/0	35	62
TO810	TEC.70/0	25	63
TO901	TE0.2/PT	50	148
TO910	TE0.2	75	86
TP100	TPL.4	40	131
TP200	TPL.4/PS	40	132
TR110	TR.2	100	130
TR111	TR.2/PT	25	148
TR200	TR.4	50	130
TTM04	TTM/04	10	173
TTM12	TTM/12	10	173
TTM15	TTM/15	10	173
TUM05	TUM/05	10	173
TUM06	TUM/06	10	173
TUM07	TUM/07	10	173
TUM08	TUM/08	10	173
TUM16	TUM/16	10	173
VL103	CO/5	50	168
VP101	VPC/PT	25	148
VP101GR	VPC/PT/GR	25	148
VP201	VPC/PT [Ex]i	25	148
VP300GR	VPC.2/GR	120	125
VP310	VPC.2 [EX]I	120	125
VP500GR	VPD.2/GR	40	126
VP501GR	VPD/PT/GR	25	148
VP560	VPD.2 [EX]I	40	126
VP561	VPD/PT[Ex]i	25	148
WP30002	WP5-14	500	176
WP30003	WP5-16	500	176
WP30005	WP75-14	500	176
WP30006	WP75-16	500	176
WP30009	WP1-14	500	176
WP30010	WP1-18	500	176
WP30013	WP15-14	500	176
WP30014	WP15-18	500	176
WP30016	WP25-14	500	176

W

CODE	TYPE	QTY. per pk.	PAGE
WP30017	WP25-19	500	176
WP30019	WP40-16	500	176
WP30020	WP40-20	500	176
WP30022	WP60-20	100	176
WP30023	WP60-26	500	176
WP30024	WP100-21	100	176
WP30025	WP100-28	500	176
WP30026	WP160-22	100	176
WP30027	WP160-28	500	176
WP30028	WP250-29	50	176
WP30029	WP250-32	500	176
WP30030	WP350-30	50	176
WP30031	WP350-41	500	176
WP30032	WP500-40	50	176
WP30033	WP500-41	500	176
WP90001	WPD05/15	500	177
WP90002	WPD75/15	500	177
WP90003	WPD01/15	500	177
WP90004	WPD15/16	500	177
WP90005	WPD25/18	500	177
WP90006	WPD04/23	500	177
WPN10508	WPN0508	1000	177
WPN10758	WPN0758	1000	177
WPN11010	WPN1010	1000	177
WPN11015	WPN1015	500	177
WPN11510	WPN1510	1000	177
WPN11615	WPN1615	1000	177
WPN12510	WPN2510	1000	177
WPN12515	WPN2515	250	177
WPN14012	WPN4012	1000	177
WPN16012	WPN6012	500	177
Z121017	ACI121017	25	151
Z121019	ACI121019	25	151
Z121026	ACI121026	100	155
Z121116	ACI121116	10	152
Z121118	ACI121118	50	155
Z121119	ACI121119	100	155
Z121121	ACI121121	100	155
Z121123	ACI121123	1	155
Z121211	ACI121211	25	155
Z121212	ACI121212	25	155
Z121213	ACI121213	20	154
Z121214	ACI121214	20	154
Z121215	ACI121215	20	154
Z121216	ACI121216	10	154
Z121217	ACI121217	10	154
Z121218	ACI121218	10	154
Z121219	ACI121219	10	154

CODE	TYPE	QTY. per pk.	PAGE
Z121221	ACI121221	50	155
Z121228	ACI121228	20	152
Z121301	ACI121301	10	152
Z121307	ACI121307	50	155
Z121311	ACI121311	20	152
Z121314	ACI121314	20	152
Z121316	ACI121316	20	153
Z121317	ACI121317	10	153
Z121318	ACI121318	10	153
Z121319	ACI121319	10	153
Z121410	ACI121410	10	153
Z121415	ACI121415	20	152
Z121421	ACI121421	100	155

Z

A

TYPE	CODE	QTY. per pk.	PAGE
ACB.120/BB	AC400	12	82
ACB.185/BB	AC700	12	82
ACB.70/BB	AC100	12	82
ACI121017	Z121017	25	151
ACI121019	Z121019	25	151
ACI121026	Z121026	100	155
ACI121116	Z121116	10	152
ACI121118	Z121118	50	155
ACI121119	Z121119	100	155
ACI121121	Z121121	100	155
ACI121123	Z121123	1	155
ACI121211	Z121211	25	155
ACI121212	Z121212	25	155
ACI121213	Z121213	20	154
ACI121214	Z121214	20	154
ACI121215	Z121215	20	154
ACI121216	Z121216	10	154
ACI121217	Z121217	10	154
ACI121218	Z121218	10	154
ACI121219	Z121219	10	154
ACI121221	Z121221	50	155
ACI121228	Z121228	20	152
ACI121301	Z121301	10	152
ACI121307	Z121307	50	155
ACI121311	Z121311	20	152
ACI121314	Z121314	20	152
ACI121316	Z121316	20	153
ACI121317	Z121317	10	153
ACI121318	Z121318	10	153
ACI121319	Z121319	10	153
ACI121410	Z121410	10	153
ACI121415	Z121415	20	152
ACI121421	Z121421	100	155
AFO.2/1+1	AF500	100	123
AFO.2/2+2	AF400	100	123
AFO/PT	AF201	50	148

B

BCA.120/BB	BC400	1	83
BCA.70/BB	BC100	1	83
BPL.4	BP100	60	131
BPL.4/PS	BP300	60	132
BPL/R	BP200	100	131
BT/2	BT006	25	149
BT/3	BT003	25	149
BT/DIN/PO	BT001	25	149
BTO	BT007	25	149
BTU	BT005	25	149

C

CAM	MA110	100	128
CAMUT	CAMT	100	144.1

TYPE	CODE	QTY. per pk.	PAGE
CB10/PT	CB431	25	148
CB10/PT (Ex)i	CBX44	25	148
CB16/PT	CB511	25	148
CB16/PT (Ex)i	CBX53	25	148
CB2/PT	CB111	50	148
CB2/PT (Ex)i	CBX13	50	148
CB2/PT(Ex)i	CBX13	50	148
CB35/PT	CB611	25	148
CB35/PT (Ex)i	CBX63	25	148
CB4/6/PT	CB241	25	148
CB4/6/PT (Ex)i	CBX25	25	148
CB50/PT	CB711	10	148
CB50/PT (Ex)i	CBX73	10	148
CB70/PT	CB811	10	148
CB70/PT (Ex)i	CBX83	10	148
CBC.10 (EX)I	CBI10	100	56
CBC.10/GR	CBC10GR	100	56
CBC.16 (EX)I	CBI16	50	56
CBC.16/GR	CBC16GR	50	56
CBC.16/PT(Ex)i	CBI161	25	148
CBC.16/PT/GR	CB161GR	25	148
CBC.2 (EX)I	CBI02	120	55
CBC.2-10/PT(Ex)i	CBI061	50	148
CBC.2-10/PT/GR	CB061GR	50	148
CBC.2/GR	CBC02GR	120	55
CBC.35 (EX)I	CBI35	50	56
CBC.35/GR	CBC35GR	50	56
CBC.35/PT(Ex)i	CBI351	25	148
CBC.35/PT/GR	CB351GR	25	148
CBC.4 (EX)I	CBI04	100	55
CBC.4/GR	CBC04GR	100	55
CBC.6 (EX)I	CBI06	100	55
CBC.6/GR	CBC06GR	100	55
CBD.10	CB440	100	68
CBD.10 (EX)I	CBX45	100	68
CBD.16	CB510	50	68
CBD.16 (EX)I	CBX52	50	68
CBD.2	CB110	120	67
CBD.2 (EX)I	CBX12	120	67
CBD.35	CB610	75	68
CBD.35 (EX)I	CBX62	75	68
CBD.4	CB240	100	67
CBD.4 (EX)I	CBX24	100	67
CBD.50	CB710	50	69
CBD.50 (EX)I	CBX72	50	69
CBD.50/GR	CB710GR	50	69
CBD.6	CB340	100	67
CBD.6 (EX)I	CBX34	100	67

TYPE	CODE	QTY. per pk.	PAGE
CBD.70	CB810	40	69
CBD.70 (EX)I	CBX82	40	69
CBD.70/GR	CB810GR	40	69
CBD/SH	CB009	10	168
CBE.2	CE110	70	86
CBF.04/GR	CBF04GR	50	97
CBF.4 (Ex)i	CBF04I	50	97
CBF.4/C230/GR	CBF423GR	50	103
CBF.4/C48/GR	CBF448GR	50	103
CBR.2	CR110	75	57
CBR.2 (EX)I	CI110	75	57
CBR.2/GR	CR110GR	75	57
CBR/PT	CR111	25	148
CBS.2	CBS02	100	104
CBS.2 (Ex)i	CBS02I	100	104
CBS.2/GR	CBS02GR	100	104
CBS.4	CBS04	80	104
CBS.4 (Ex)i	CBS04I	80	104
CBS.4/GR	CBS04GR	80	104
CCH/2.5-4	CCH02	1	175
CCH/6	CCH06	1	175
CCV/2.5	CCV03	1	175
CCV/4	CCV04	1	175
CCV/5	CCV05	1	175
CF.12/1+1	CF100	50	133
CF.12/2+2	CF200	25	133
CF.12/CPT	CF900	40	133
CHP.2 (EX)I	HVP905	20	48
CHP.2/GR	HVP900GR	20	48
CHP.2D (EX)I	HVP915	20	48
CHP.2D/GR	HVP910GR	20	48
CHTE.2	HVT900	20	49
CHTE.2D	HVT910	20	49
CIL/115-230	SF510	10	169
CIL/12-48	SF518	10	169
CO/5	VL103	50	168
CONT/1,5	CONTC01	10	144
CONT/2,5	CONTC02	10	144
CONT/6/6	CONT606	5	143
CONT616	CONT616	5	143
CONTC/10	CONTC10	5	144
CONTC/16	CONTC16	5	144
CONTC/2/16	CONT216	20	143
CONTC/2/25	CONT225	10	143
CONTC/2/35	CONT235	5	143
CONTC/2/6	CONT206	20	143
CONTC/25	CONTC25	5	144
CONTC/3/16	CONT316	5	143

D

TYPE	CODE	QTY. per pk.	PAGE
CONTC/3/6	CONTC306	10	143
CONTC/4	CONTC04	10	144
CONTC/6	CONTC06	10	144
CPF/5	CPF05	20	167
CPFE/2	CPFE02		167
CPFE/4	CPFE04		167
CVF.4	CV100	100	124
CVF.4/GR	CV100GR	100	124
CVF/PT	CV101	25	148
CVF/PT (Ex)i	CV201	25	148
CVF/PT/GR	CV101GR	25	148
DAS.4	DS100	120	92
DAS.4 (EX)I	DS200	120	92
DAS.4/A	DS111	20	118
DAS.4/A/GR	DS111GR	20	118
DAS.4/B	DS112	20	118
DAS.4/B/GR	DS112GR	20	118
DAS.4/C	DS113	20	119
DAS.4/C/GR	DS113GR	20	119
DAS.4/CI	DS117	120	92
DAS.4/CI (EX)I	DS217	120	92
DAS.4/CI/GR	DS117GR	120	92
DAS.4/D	DS114	20	119
DAS.4/D/GR	DS114GR	20	119
DAS.4/D12	DSD012	20	114
DAS.4/D12/GR	DSD012GR	20	114
DAS.4/D24	DSD024	20	115
DAS.4/D24/GR	DSD024GR	20	115
DAS.4/D5	DSD005	20	114
DAS.4/D5/GR	DSD005GR	20	114
DAS.4/D60	DSD060	20	115
DAS.4/D60/GR	DSD060GR	20	115
DAS.4/DD	DS120	20	121
DAS.4/DD/GR	DS120GR	20	121
DAS.4/E	DS115	20	120
DAS.4/E/GR	DS115GR	20	120
DAS.4/GR	DS100GR	120	92
DAS.4/I	DS119	20	120
DAS.4/I/GR	DS119GR	20	120
DAS.4/L	DS130	20	121
DAS.4/L/GR	DS130GR	20	121
DAS.4/SS	DS110	20	93
DAS.4/SS/GR	DS110GR	20	93
DAS.4/T	DS128	20	122
DAS.4/T/GR	DS128GR	20	122
DAS.4/U	DS129	20	122
DAS.4/U/GR	DS129GR	20	122
DAS.4/V120	DSV120	20	117

TYPE	CODE	QTY. per pk.	PAGE
DAS.4/V120/GR	DSV120GR	20	117
DAS.4/V230	DSV230	20	117
DAS.4/V230/GR	DSV230GR	20	117
DAS.4/V24	DSV024	20	116
DAS.4/V24/GR	DSV024GR	20	116
DAS.4/V48	DSV048	20	116
DAS.4/V48/GR	DSV048GR	20	116
DAS/PT	DS101	25	148
DAS/PT (Ex)i	DS201	25	148
DAS/VCE	DS108	25	168
DAS/VCI	DS107	25	168
DBC.2	DB100	120	90
DBC.2 (EX)I	DB200	120	90
DBC.2/CI	DB117	120	90
DBC.2/CI/GR	DB117GR	120	90
DBC.2/GR	DB100GR	120	90
DBC.4(Ex)i	DB500	100	91
DBC.4/CI(Ex)i	DB517	100	91
DBC.4/CI/GR	DB417GR	100	91
DBC.4GR	DB400GR	100	91
DBC/PT	DB101	25	148
DBC/PT(Ex)i	DB201	25	148
DFE.1+1/R	DFE01R	20	170
DFE.1+2/R	DFE02R	20	170
DFE.2+2/R	DFE03R	20	170
DFE.2P/R	DFE04R	20	170
DFH/1/R	DH01R	25	170
DFH/2/R	DH02R	25	170
DFH/3/R	DH03R	25	170
DFH/4/R	DH04R	25	170
DFM/300	DF300	50	171
DFM/400	DF400	50	171
DFM/500	DF500	50	171
DFM/600	DF600	50	171
DFM/700	DF700	50	171
DFM/800	DF800	50	171
DFM/900	DF900	50	171
DFP/2/R	DFP2R	50	170
DFS.4/PT/GR	DS401GR	25	148
DFU/1/R	DU01R	50	170
DFU/2/R	DU02R	50	170
DFU/3/R	DU03R	50	170
DFU/4/R	DU04R	50	170
DFU/5/R	DU05R	50	170
DFU/6/R	DU06R	50	170
DFU/7/R	DU07R	50	170
DSF.4	DA200	80	100
DSF.4/GR	DA200GR	80	100

E

TYPE	CODE	QTY. per pk.	PAGE
DSFA.4	DA100	100	101
DSFA.4/GR	DA100GR	100	101
DSS.4	DS400	100	105
DSS.4	DS400	100	93
DSS.4/GR	DS400GR	100	93
DSS.4/GR	DS400GR	100	105
DSS/PT	DS301	25	148
DSS/PT/GR	DS301GR	25	148
EFB.2/10/B	EFB0210B	5	161
EFB.2/10/R	EFB0210R	5	161
EFB.2/2/B	EFB0202B	20	161
EFB.2/3/B	EFB0203B	20	161
EFB.2/2/R	EFB0202R	20	161
EFB.2/3/R	EFB0203R	20	161
EFB.2/5/B	EFB0205B	10	161
EFB.2/5/R	EFB0205R	10	161
EFB.4/10/B	EFB0410B	5	161
EFB.4/10/R	EFB0410R	5	161
EFB.4/2/B	EFB0402B	20	161
EFB.4/3/B	EFB0403B	20	161
EFB.4/2/R	EFB0402R	20	161
EFB.4/3/R	EFB0403R	20	161
EFB.4/5/B	EFB0405B	10	161
EFB.4/5/R	EFB0405R	10	161
EFC.2/1+2/BL	EFC210BL	120	13
EFC.2/1+2/GR	EFC210GR	120	13
EFC.2/1+2/PT/BL	EFC211BL	25	148
EFC.2/1+2/PT/GR	EFC211GR	25	148
EFC.2/2+2/BL	EFC220BL	90	13
EFC.2/2+2/GR	EFC220GR	90	13
EFC.2/2+2/PT/BL	EFC221BL	25	148
EFC.2/2+2/PT/GR	EFC221GR	25	148
EFC.2/BL	EFC200BL	160	13
EFC.2/GR	EFC200GR	160	13
EFC.2/PT/BL	EFC201BL	25	148
EFC.2/PT/GR	EFC201GR	25	148
EFC.4/1+2/BL	EFC410BL	110	15
EFC.4/1+2/GR	EFC410GR	110	15
EFC.4/1+2/PT/BL	EFC411BL	25	148
EFC.4/1+2/PT/GR	EFC411GR	25	148
EFC.4/2+2/BL	EFC420BL	90	15
EFC.4/2+2/GR	EFC420GR	90	15
EFC.4/2+2/PT/BL	EFC421BL	25	148
EFC.4/2+2/PT/GR	EFC421GR	25	148
EFC.4/BL	EFC400BL	120	15
EFC.4/GR	EFC400GR	120	15
EFC.4/PT/BL	EFC401BL	25	148
EFC.4/PT/GR	EFC401GR	25	148

TYPE	CODE	QTY. per pk.	PAGE
EFCE.2	EFCE200	80	14
EFCE.2/1+2	EFCE210	50	14
EFCE.2/2+2	EFCE220	60	14
EFCE.4	EFCE400	70	16
EFCE.4/1+2	EFCE410	60	16
EFCE.4/2+2	EFCE420	90	16
EFD.2/BL	EFD200BL	130	17
EFD.2/CI/BL	EFD210BL	30	17
EFD.2/CI/GR	EFD210GR	30	17
EFD.2/E/GR	EFD220GR	30	17
EFD.2/GR	EFD200GR	130	17
EFD.2/PT/BL	EFD201BL	25	148
EFD.2/PT/GR	EFD201GR	25	148
EFD.4/CI/BL	EFD410BL	40	18
EFD.4/BL	EFD400BL	100	18
EFD.4/CI/GR	EFD410GR	40	18
EFD.4/E/GR	EFD420GR	40	18
EFD.4/GR	EFD400GR	100	18
EFD.4/PT/BL	EFD401BL	25	148
EFD.4/PT/GR	EFD401GR	25	148
EFDE.2	EFDE200	30	19
EFDE.4	EFDE400	40	19
EFDS.2/1S/GR	EFDS210GR	45	22
EFDS.2/GR	EFDS200GR	45	22
EFDS.2/P/GR	EFDS220GR	45	22
EFDS.2/PT/GR	EFDS201GR	25	148
EFF.4/BL	EFF400BL	35	23
EFF.4/C230/GR	EFF423GR	35	23
EFF.4/C48/GR	EFF448GR	35	23
EFF.4/GR	EFF400GR	35	23
EFS.2/BL	EFS200BL	75	20
EFS.2/GR	EFS200GR	75	20
EFS.4/BL	EFS400BL	70	20
EFS.4/GR	EFS400GR	70	20
EFT.2/BL	EFT200BL	100	21
EFT.2/GR	EFT200GR	100	21
EFT.2/PT/BL	EFT201BL	25	148
EFT.2/PT/GR	EFT201GR	25	148
EFT.2/S/GR	EFT250GR	100	21
EFT.2/S/PT/GR	EFT251GR	25	148
EFTE.2	EFTE200	35	21
F5/1 A	FN006ST	100	169
F5/1.6 A	FN007ST	100	169
F5/10 A	FN015ST	100	169
F5/100 mA	FN001ST	100	169
F5/12 A	FN016ST	100	169
F5/2 A	FN008ST	100	169
F5/2.5 A	FN009ST	100	169

TYPE	CODE	QTY. per pk.	PAGE
F5/200 mA	FN002ST	100	169
F5/3.15 A	FN010ST	100	169
F5/315 mA	FN003ST	100	169
F5/4 A	FN011ST	100	169
F5/5 A	FN012ST	100	169
F5/500 mA	FN004ST	100	169
F5/6.3 A	FN013ST	100	169
F5/630 mA	FN005ST	100	169
F5/8 A	FN014ST	100	169
FDP.2	FD100	70	124
FDP.2/GR	FD100GR	70	124
FDP/PT	FD101	25	148
FDP/PT/GR	FD101GR	25	148
FFS.4	FF100	120	94
FFS.4/GR	FF100GR	120	94
FFS/PT	FF101	25	148
FFS/PT/GR	FF101GR	25	148
FJ402	FJ402	80	144.2
FJ403	FJ403	60	144.2
FJ404	FJ404	40	144.2
FL201	FL201	100	169
FL202	FL202	100	169
FPC.10	FP100	70	108
FPC.10	FP100	70	102
FPL.10/C	FP300	70	102
FPL.10/C230	FP923	70	103
FPL.10/C48	FP948	70	103
FPL.10/L	FP200	70	102
FVS.4	FV100	120	94
FVS.4/GR	FV100GR	120	94
FVS/PT	FV101	25	148
FVS/PT/GR	FV101GR	25	148
FVS/VCE	FV108	25	168
FVS/VCI	FV107	25	168
GPA.150	GA200	8	60
GPA.150/FIX	GF200	8	60
GPA.150/FX/GR	GF200GR	8	60
GPA.150/GR	GA200GR	8	60
GPA.240	GA300	4	61
GPA.240/FIX	GF300	4	61
GPA.240/FIX/GR	GF300GR	4	61
GPA.240/GR	GA300GR	4	61
GPA.70	GA400	25	58
GPA.70 [EXI]	GA410	25	58
GPA.70/FIX	GF400	25	58
GPA.70/FIX/GR	GF400GR	25	58
GPA.70/GR	GA400GR	25	58
GPA.95	GA100	10	59

TYPE	CODE	QTY. per pk.	PAGE
GPA.95 [EXI]	GA110	10	59
GPA.95/FIX	GF100	10	59
GPA.95/FIX/GR	GF100GR	10	59
GPA.95/GR	GA100GR	10	59
GPM.150/BB	GP400	6	72
GPM.150/BB/FIX	GP410	6	72
GPM.150/BB/FIX/GR	GP410GR	6	72
GPM.150/BB/GR	GP400GR	6	72
GPM.150/BC	GP500	6	75
GPM.150/BC/FIX	GP510	4	75
GPM.150/BC/FIX/GR	GP510GR	4	75
GPM.150/BC/GR	GP500GR	5	75
GPM.150/C/BB	GP425	6	80
GPM.150/C/BB/FIX	GP435	6	81
GPM.150/CC	GP600	6	78
GPM.150/CC/FIX	GP610	6	78
GPM.150/CC/FIX/GR	GP610GR	6	78
GPM.150/CC/GR	GP600GR	6	78
GPM.150/O/BB	GP420	6	80
GPM.150/O/BB/FIX	GP430	6	81
GPM.240/BB	GP700	4	73
GPM.240/BB/FIX	GP710	4	73
GPM.240/BB/FIX/GR	GP710GR	4	73
GPM.240/BB/GR	GP700GR	4	73
GPM.240/BC	GP800	4	76
GPM.240/BC/FIX	GP810	4	76
GPM.240/BC/FIX/GR	GP810GR	4	76
GPM.240/BC/GR	GP800GR	4	76
GPM.240/C/BB	GP725	4	81
GPM.240/C/BB/FIX	GP735	4	81
GPM.240/CC	GP900	4	79
GPM.240/CC/FIX	GP910	4	79
GPM.240/CC/FIX/GR	GP910GR	4	79
GPM.240/CC/GR	GP900GR	4	79
GPM.240/O/BB	GP720	4	81
GPM.240/O/BB/FIX	GP730	4	81
GPM.95/BB	GP100	10	71
GPM.95/BB/FIX	GP110	10	71
GPM.95/BB/FIX/GR	GP110GR	10	71
GPM.95/BB/GR	GP100GR	10	71
GPM.95/BC	GP200	10	74
GPM.95/BC/FIX	GP210	10	74
GPM.95/BC/FIX/GR	GP210GR	10	74
GPM.95/BC/GR	GP200GR	10	74
GPM.95/C/BB	GP125	10	80
GPM.95/C/BB/FIX	GP135	10	80
GPM.95/CC	GP300	10	77
GPM.95/CC/FIX	GP310	10	77

H

TYPE	CODE	QTY. per pk.	PAGE
GPM.95/CC/FIX/GR	GP310GR	10	77
GPM.95/CC/GR	GP300GR	10	77
GPM.95/O/BB	GP120	10	80
GPM.95/O/BB/FIX	GP130	10	80
HCD.1 [EX]I	HC210	40	47
HCD.1/GR	HC200GR	40	47
HCD.1/PT/GR	HC201GR	25	148
HDE.2/GR	HL500GR	50	42
HFR.4/GR	HF210GR	70	46
HFR.4/M/GR	HF310GR	100	46
HFR.4/PT/GR	HF211GR	25	148
HLD.2 [EX]I	HD510	50	42
HLD.2/CI/GR	HL210GR	50	42
HLD.2/GR	HL200GR	50	42
HLD.2/PT/GR	HL201GR	25	148
HLD.2/PT/GR	HL201GR	25	148
HMD.1 [EX]I	HD300	50	37
HMD.1/CI/GR	HD120GR	50	37
HMD.1/GR	HD200GR	50	37
HMD.1/PT[Ex]i	HD301	25	148
HMD.1/PT/GR	HD201GR	25	148
HMD.1/X/GR	HD130GR	50	40
HMD.2/GR	HD100GR	60	39
HMD.2N [EX]I	HD410	40	38
HMD.2N/3DC/GR	HD430GR	40	41
HMD.2N/CI/GR	HD450GR	40	38
HMD.2N/DD/GR	HD420GR	40	41
HMD.2N/GR	HD400GR	40	38
HMD.2N/X/GR	HD440GR	40	40
HMD.2N/X1/GR	HD441GR	40	40
HMD/PT/GR	HD101GR	25	148
HMF/PT/GR	HF111GR	25	148
HMFA.2/GR	HF300GR	80	45
HMM.1 [EX]I	HI400	100	27
HMM.1/1+2 [EX]I	HI410	80	27
HMM.1/1+2/GR	HM410GR	80	27
HMM.1/2+2 [EX]I	HI420	60	27
HMM.1/2+2/GR	HM420GR	60	27
HMM.1/GR	HM400GR	100	27
HMM.10 [EX]I	HI330	30	31
HMM.10/GR	HM330GR	30	31
HMM.16 [EX]I	HI340	30	31
HMM.16/GR	HM340GR	30	31
HMM.2 [EX]I	HI500	80	28
HMM.2/1+2 [EX]I	HI510	80	28
HMM.2/1+2/GR	HM510GR	80	28
HMM.2/1+2/S/GR	HMS20GR	80	29
HMM.2/2+2 [EX]I	HI520	60	28

TYPE	CODE	QTY. per pk.	PAGE
HMM.2/2+2/A/GR	HM170GR	60	29
HMM.2/2+2/GR	HM520GR	60	28
HMM.2/2+2/S/GR	HMS10GR	60	29
HMM.2/GR	HM500GR	80	28
HMM.4 [EX]I	HI250	60	30
HMM.4/1+2 [EX]I	HI210	40	30
HMM.4/1+2/GR	HM210GR	40	30
HMM.4/2+2 [EX]I	HI220	20	30
HMM.4/2+2/GR	HM220GR	40	30
HMM.4/GR	HM250GR	60	30
HMM.6 [EX]I	HI320	30	31
HMM.6/GR	HM320GR	30	31
HMR.16/D/GR	HM360GR	30	32
HMR.16/GR	HM350GR	15	32
HMS.2/GR	HS200GR	80	44
HMT.1/1+2/PT	HM411GR	25	148
HMT.1/1+2/PT[Ex]i	HI411	25	148
HMT.1/2+2/PT	HM421GR	25	148
HMT.1/2+2/PT[Ex]i	HI421	25	148
HMT.1/PT [Ex]i	HI401	25	148
HMT.1/PT/GR	HM401GR	25	148
HMT.2/1+2/PT[Ex]i	HI511	25	148
HMT.2/1+2/PT/GR	HM511GR	25	148
HMT.2/2+2/PT[Ex]i	HI521	25	148
HMT.2/2+2/PT/GR	HM521GR	25	148
HMT.2/PT [Ex]i	HI501	25	148
HMT.2/PT/GR	HM501GR	25	148
HMT.4/PT [Ex]i	HI251	25	148
HMT.4/PT/GR	HM251GR	25	148
HMT.6/PT [Ex]i	HI321	25	148
HMT.6/PT/GR	HM321GR	25	148
HP.2 [EX]I	HI130	100	50
HP.2/GR	HP150GR	100	50
HP/PT/GR	HP101GR	25	148
HPC.2 [EX]I	HI131	100	51
HPC.2/GR	HP160GR	100	51
HPP.2 [EX]I	HI132	100	50
HPP.2/GR	HP170GR	100	50
HPV/PT/GR	HV111GR	25	148
HSCB.4/GR	HB100GR	90	44
HSCB.4/PT/GR	HB101GR	25	148
HSCB.6/CPM	HB205	40	168
HSCB.6/GR	HB200GR	60	44
HSCB.6/PT/GR	HB201GR	25	148
HSCB.6/PO/2	HB203	40	168
HSCB.6/PO/4	HB204	20	168
HTE.1	HT400	80	33
HTE.1/1+2	HT410	80	33

M

TYPE	CODE	QTY. per pk.	PAGE
HTE.1/2+2	HT420	60	33
HTE.10	HT330	30	36
HTE.16	HT340	30	36
HTE.2	HT500	80	34
HTE.2/1+2	HT510	80	34
HTE.2/2+2	HT520	60	34
HTE.4	HT250	60	35
HTE.4/1+2	HT260	40	35
HTE.4/2+2	HT270	20	35
HTE.6	HT320	30	36
HTTE.2	HLT500	50	43
HVPC.2 [EX]I	HVP305	120	48
HVPC.2/GR	HVP300GR	120	48
HVTE.2	HVT500	80	49
KITLSN/12-24	KIT1224	1	169
KITLSN/70-380	KIT70380	50	169
MAC.6	MA100	80	128
MBL.120/10	MB300	10	85
MBL.150/12	MB400	10	85
MBL.50/6	MB100	10	84
MBL.95/8	MB200	10	84
MPFA.4	MF100	100	101
MPFA.4/GR	MF100GR	100	101
MPS.2/PT	MP121	25	148
MPS.2/PT[EX]i	MP131	25	148
MPS.2/PT/GR	MP121GR	25	148
MPS.4	MP950	100	105
MPS.4/GR	MP950GR	100	105
MPS.4/PT	MP901	25	148
MPS.4/PT[EX]i	MP902	25	148
MPS.4/PT/GR	MP901GR	25	148
MPS.4/SW [EX]I	MP960	100	105
MS/8X10/N	MZ300N	1	136
MS/8X10/T	MZ300T	1	136
NU0800SP	NU0800SP	500	185
NU08515	NU08515V	500	184
NU0851510	NU0851510V	500	184
NU0851520	NU0851520V	500	184
NU0851530	NU0851530V	500	184
NU0851540	NU0851540V	500	184
NU0851550	NU0851550V	500	184
NU0851551	NU0851551V	500	184
NU0851560	NU0851560V	500	184
NU0851570	NU0851570V	500	184
NU0851580	NU0851580V	500	184
NU0851590	NU0851590V	500	184
NU08516	NU08516V	500	184
NU0851600	NU0851600V	500	184

N

TYPE	CODE	QTY. per pk.	PAGE
NU0851601	NU0851601V	500	184
NU0851651	NU0851651V	500	184
NU08517	NU08517V	500	184
NU0851701	NU0851701V	500	184
NU0851751	NU0851751V	500	184
NU08518	NU08518V	500	184
NU0851801	NU0851801V	500	184
NU0851851	NU0851851V	500	184
NU08519	NU08519V	500	184
NU0851901	NU0851901V	500	184
NU0851951	NU0851951V	500	184
NU0851A	NU0851AV	500	184
NU0851B	NU0851BV	500	184
NU0851C	NU0851CV	500	184
NU0851D	NU0851DV	500	184
NU0851E	NU0851EV	500	184
NU0851F	NU0851FV	500	184
NU0851G	NU0851GV	500	184
NU0851H	NU0851HV	500	184
NU0851I	NU0851IV	500	184
NU0851J	NU0851JV	500	184
NU0851K	NU0851KV	500	184
NU0851L	NU0851LV	500	184
NU0851M	NU0851MV	500	184
NU0851N	NU0851NV	500	184
NU0851O	NU0851OV	500	184
NU0851P	NU0851PV	500	184
NU0851Q	NU0851QV	500	184
NU0851R	NU0851RV	500	184
NU0851S	NU0851SV	500	184
NU0851SP	NU0851SP	500	185
NU0851T	NU0851TV	500	184
NU0851U	NU0851UV	500	184
NU0851V	NU0851VW	500	184
NU0851W	NU0851WV	500	184
NU0851X	NU0851XV	500	184
NU0851Y	NU0851YV	500	184
NU0851Z	NU0851ZV	500	184
NU0861SP	NU0861SP	400	185
NU1051SP	NU1051SP	500	185
NU1055SP	NU1055SP	450	185
NU1061SP	NU1061SP	400	185
NU1065SP	NU1065SP	400	185
NUL1061	NUL1061SP		185
NUPUTUK50SP	NUPUTUK50SP		185
NUT12SP	NUT12SP	300	186
NUT12YSP	NUT12YSP		186
NUT15SP	NUT15SP	400	186

P

TYPE	CODE	QTY. per pk.	PAGE
NUT15YSP	NUT15YSP		186
NUT18SP	NUT18SP		186
NUT18YSP	NUT18YSP		186
NUT23SP	NUT23SP		186
NUT23YSP	NUT23YSP		186
NUWDK50SP	NUWDK50SP		185
NUWDU50SP	NUWDU50SP	500	185
NUWG051SP	NUWG051SP		185
PDF.2	PF100	75	125
PDF.2/GR	PF100GR	75	124
PDF/PT	PF101	25	148
PIL/2	PIL02	15	156
PIL/3	PIL03	15	156
PIL/4	PIL04	15	156
PIL/8	PIL08	10	156
PM/10/10	PM100	10	156
PM/10/2	PM102	25	156
PM/10/3	PM103	25	156
PM/10/5	PM105	25	156
PM/11/10	PM110	10	156
PM/11/2	PM112	25	156
PM/11/3	PM113	25	156
PM/11/5	PM115	25	156
PM/12/10	PM120	10	156
PM/12/2	PM122	25	156
PM/12/3	PM123	25	156
PM/12/5	PM125	25	156
PM/20/10	PM210	10	156
PM/20/2	PM202	25	156
PM/20/3	PM203	25	156
PM/20/5	PM205	25	156
PM/25/10	PM250	10	156
PM/25/2	PM252	25	156
PM/25/3	PM253	25	156
PM/25/5	PM255	25	156
PM/30/10	PM310	10	156
PM/30/3	PM303	25	156
PM/30/5	PM305	25	156
PM/40/10	PM400	10	156
PM/40/2	PM402	25	156
PM/40/3	PM403	25	156
PM/40/5	PM405	25	156
PM/41/10	PM410	10	156
PM/41/2	PM412	25	156
PM/41/3	PM413	25	156
PM/41/5	PM415	25	156
PM/51/10	PM510	10	156
PM/51/3	PM513	25	156

TYPE	CODE	QTY. per pk.	PAGE
PM/51/5	PM515	25	156
PM/60/10	PM610	10	156
PM/60/2	PM602	25	156
PM/60/3	PM603	25	156
PM/60/5	PM605	25	156
PMP/01	PMP01	8	163
PMP/02	PMP02	8	163
PMP/04	PMP04	8	163
PMP/05	PMP05	8	163
PMP/06	PMP06	8	163
PMP/07	PMP07	8	163
PMP/08	PMP08	8	163
PMP/13	PMP13	8	163
PMP/16	PMP16	8	163
PMP/17	PMP17	8	163
PMP/25	PMP25	8	163
PMP/35	PMP35	8	163
PMP/42	PMP42	8	163
PMP/56	PMP56	8	163
PMP/58	PMP58	8	163
POF/06	POF06	15	162
POF/07	POF07	15	162
POF/08	POF08	15	162
POF/11	POF11	25	162
POF/12	POF12	25	162
POF/13	POF13	25	162
POF/14	POF14	25	162
POF/150/2	P0152	10	162
POF/150/3	P0153	10	162
POF/17	POF17	25	162
POF/20	POF20	25	162
POF/240/2	P0242	10	162
POF/240/3	P0243	10	162
POF/35	POF35	15	162
POF/44	POF44	25	162
POF/53	POF53	25	162
POF/54	POF54	25	162
POF/55	POF55	25	162
POF/56	POF56	25	162
POF/57	POF57	25	162
POF/70	POF70	25	162
POF/95/2	P0952	10	162
POF/95/3	P0953	10	162
POF/99	POF99	25	162
POLM.1215	QPOL1203	10	142
POLM.1215/BLU	QPOL1205	10	142
POLM.1215/TE	QPOL1204	10	142
POS/08	POS08	15	164

TYPE	CODE	QTY. per pk.	PAGE
POS/11	POS11	25	164
POS/41	POS41	25	164
POS/42	POS42	25	164
POS/43	POS43	25	164
POS/44	POS44	25	164
POS/53	POS53	15	164
POS/66	POS66	25	164
POS/72	POS72	25	164
POS/77	POS77	25	164
POS/93	POS93	25	164
PR/2/AC	PR009	100	151
PR/2/AC/ZB	PR909	100	151
PR/2/AS	PR010	100	151
PR/2/AS/ZB	PR910	100	151
PR/3/AC	PR003	40	151
PR/3/AC/ZB	PR903	40	151
PR/3/AS	PR005	40	151
PR/3/AS/ZB	PR905	40	151
PR/3/PA	PR006	20	151
PR/3/PA/ZB	PR906	20	151
PR/3/PP	PR007	20	151
PR/3/PP/ZB	PR907	20	151
PR/DIN/AC	PR001	20	151
PR/DIN/AC/ZB	PR901	20	151
PR/DIN/AL	PR002	20	151
PR/DIN/AS	PR004	20	151
PR/DIN/AS/ZB	PR904	20	151
PRP/7/G	PRP070G	10	173
PSD/A	PD001	50	166
PSD/B	PD002	50	166
PSD/C	PD003	50	166
PSD/D	PD004	50	166
PSD/J	PD014	50	166
PSD/K	PD011	50	166
PSD/L	PD009	50	166
PSD/N	PD013	50	166
PSD/O	PD017	50	166
PSD/P	PD015	50	166
PTC/1/00	PTC0100	8	157
PTC/1/02	PTC0102	25	157
PTC/1/03	PTC0103	25	157
PTC/1/05	PTC0105	25	157
PTC/1/10	PTC0110	10	157
PTC/10/00	PTC1000	8	157
PTC/10/02	PTC1002	25	157
PTC/10/03	PTC1003	25	157
PTC/10/05	PTC1005	25	157
PTC/10/10	PTC1010	10	157

TYPE	CODE	QTY. per pk.	PAGE
PTC/11/00	PTC1100	8	157
PTC/11/02	PTC1102	25	157
PTC/11/03	PTC1103	25	157
PTC/11/05	PTC1105	25	157
PTC/11/10	PTC1110	10	157
PTC/16/00	PTC1600	8	157
PTC/16/02	PTC1602	25	157
PTC/16/03	PTC1603	25	157
PTC/16/05	PTC1605	25	157
PTC/16/10	PTC1610	10	157
PTC/2/00	PTC0200	8	157
PTC/2/02	PTC0202	25	157
PTC/2/03	PTC0203	25	157
PTC/2/05	PTC0205	25	157
PTC/2/10	PTC0210	10	157
PTC/20/00	PTC2000	8	157
PTC/20/02	PTC2002	25	157
PTC/20/03	PTC2003	25	157
PTC/20/05	PTC2005	25	157
PTC/20/10	PTC2010	10	157
PTC/3/00	PTC0300	8	157
PTC/3/02	PTC0302	25	157
PTC/3/03	PTC0303	25	157
PTC/3/05	PTC0305	25	157
PTC/3/10	PTC0310	10	157
PTC/4/00	PTC0400	8	157
PTC/4/02	PTC0402	25	157
PTC/4/03	PTC0403	25	157
PTC/4/05	PTC0405	25	157
PTC/4/10	PTC0410	10	157
PTC/5/00	PTC0500	8	157
PTC/5/02	PTC0502	25	157
PTC/5/03	PTC0503	25	157
PTC/5/05	PTC0505	25	157
PTC/5/10	PTC0510	10	157
PTC/6/00	PTC0600	8	157
PTC/6/02	PTC0602	25	157
PTC/6/03	PTC0603	25	157
PTC/6/05	PTC0605	25	157
PTC/6/10	PTC0610	10	157
PTC/8/00	PTC0800	8	157
PTC/8/02	PTC0802	25	157
PTC/8/03	PTC0803	25	157
PTC/8/05	PTC0805	25	157
PTC/8/10	PTC0810	10	157
PTM	PTM	15	150
PTMS	PTMS	36	150
PTP/2/02/B	PTP0202B	25	159

TYPE	CODE	QTY. per pk.	PAGE
PTP/2/02/R	PTP0202R	25	159
PTP/2/03/B	PTP0203B	25	159
PTP/2/03/R	PTP0203R	25	159
PTP/2/05/B	PTP0205B	25	159
PTP/2/05/R	PTP0205R	25	159
PTP/2/10/B	PTP0210B	25	159
PTP/2/10/R	PTP0210R	25	159
PTP/2/30/B	PTP0230B	25	159
PTP/2/30/R	PTP0230R	25	159
PTP/3/02/B	PTP0302B	25	159
PTP/3/02/R	PTP0302R	25	159
PTP/3/03/B	PTP0303B	25	159
PTP/3/03/R	PTP0303R	25	159
PTP/3/05/B	PTP0305B	25	159
PTP/3/05/R	PTP0305R	25	159
PTP/3/10/B	PTP0310B	25	159
PTP/3/10/R	PTP0310R	25	159
PTP/3/30/B	PTP0330B	25	159
PTP/3/30/R	PTP0330R	25	159
PTP/4/02/B	PTP0402B	25	159
PTP/4/02/R	PTP0402R	25	159
PTP/4/03/B	PTP0403B	25	159
PTP/4/03/R	PTP0403R	25	159
PTP/4/05/B	PTP0405B	25	159
PTP/4/05/R	PTP0405R	25	159
PTP/4/10/B	PTP0410B	25	159
PTP/4/10/R	PTP0410R	25	159
PTP/4/30/B	PTP0430B	25	159
PTP/4/30/R	PTP0430R	25	159
PTP/5/02/B	PTP0502B	25	159
PTP/5/02/R	PTP0502R	25	159
PTP/5/03/B	PTP0503B	25	159
PTP/5/03/R	PTP0503R	25	159
PTP/5/05/B	PTP0505B	25	159
PTP/5/05/R	PTP0505R	25	159
PTP/5/10/B	PTP0510B	25	159
PTP/5/10/R	PTP0510R	25	159
PTP/5/30/B	PTP0530B	25	159
PTP/5/30/R	PTP0530R	25	159
QBLOK.12/BLU	QBLOK1201	10	137
QBLOK.12/GR	QBLOK1203	10	137
QBLOK.12/TE	QBLOK1202	10	137
QBLOK.7/BLU	QBLOK7001	10	137
QBLOK.7/GR	QBLOK7003	10	137
QBLOK.7/TE	QBLOK7002	10	137
QBLOK1P160A6	QBLOK1P160	1	138
QBLOK1P250A10	QBLOK1P250	1	138
QBLOK1P400A10	QBLOK1P400	1	138

Q

R

S

TYPE	CODE	QTY. per pk.	PAGE
QBLOK2P100A7	QBLOK2100	4	139
QBLOK2P125A11	QBLOK2125	2	139
QBLOK2P125A15	QBLOK2126	2	139
QBLOK4P100A7	QBLOK4100	2	140
QBLOK4P125A11	QBLOK4125	1	140
QBLOK4P125A15	QBLOK4126	1	140
QBLOK4P160A14	QBLOK4161N	1	141
QBLOK4P160A9	QBLOK4160S	1	141
RFN/PT[Ex]i	RF201	25	148
RFN/PT/GR	RF101GR	25	148
RN.1 [EX]I	RN400	125	129
RN.1/GR	RN300GR	125	129
RN.2 [EX]I	RN510	110	129
RN.2/GR	RN500GR	110	129
RP.4 [EX]I	RP400	200	129
RP.4/GR	RP300GR	200	129
RP.4/PT[Ex]i	RP401	25	148
RP.4/PT/GR	RP301GR	25	148
SCB.10	SB400	80	111
SCB.10/CD	SB420	80	111
SCB.10/CD/GR	SB420GR	80	111
SCB.10/DD	SB410	80	111
SCB.10/DD/GR	SB410GR	80	111
SCB.10/GR	SB400GR	80	111
SCB.4	SB300	75	108
SCB.4/GR	SB300GR	75	108
SCB.6	SB200	100	110
SCB.6/CD	SB220	80	110
SCB.6/CD/GR	SB220GR	80	110
SCB.6/DD	SB210	80	110
SCB.6/DD/GR	SB210GR	80	110
SCB.6/GR	SB200GR	100	110
SCB/10/P/GR	SB401GR	25	148
SCB/10/PT	SB401	25	148
SCB/4/CPM	SB305	25	168
SCB/4/PO/2	SB303	40	168
SCB/4/PO/4	SB304	20	168
SCB/4/PT	SB301	25	148
SCB/4/PT/GR	SB301GR	25	148
SCB/6/CPM	SB205	25	168
SCB/6/PO/2	SB203	40	168
SCB/6/PO/4	SB204	20	168
SCB/6/PT	SB201	25	148
SCB/6/PT/GR	SB201GR	25	148
SCX/CPM	SC105	40	168
SCX/PO/2	SC103	40	168
SCX/PO/4	SC104	20	168
SD5/PT	DD501	25	165

TYPE	CODE	QTY. per pk.	PAGE
SD6/PT	DD601	25	165
SDC/5	DC005	25	165
SDC/5P	DC05P	25	165
SDC/6	DC006	25	165
SDC/6P	DC06P	25	165
SDD/1	DD001	50	166
SDD/2	DD002	50	166
SDD/5	DD005	25	165
SDD/6	DD006	25	165
SDH/4	DH004	25	165
SDH/5	DH005	25	165
SDH/6	DH006	25	165
SDH/7	DH007	25	165
SFC/CO	FC102	70	
SFO/PT	SF401	25	148
SFO/PT [Ex]i	SF601	25	148
SFO/PT/GR	SF401GR	25	148
SFR.4	SF900	70	112
SFR.4	SF900	70	106
SFR.4	SF900	70	97
SFR.4 [EX]I	SF850	70	106
SFR.4 [EX]I	SF850	70	97
SFR.4/C230	SF923	70	103
SFR.4/C230/GR	SF923GR	70	103
SFR.4/C48	SF948	70	103
SFR.4/C48/GR	SF948GR	70	103
SFR.4/D1	SFR901	70	112
SFR.4/D1/GR	SF901GR	70	112
SFR.4/D3	SFR903	70	112
SFR.4/D3/GR	SF903GR	70	112
SFR.4/GR	SF900GR	70	97
SFR.4/GR	SF900GR	70	106
SFR.4/GR	SF900GR	70	112
SFR.4/VS	SF910	50	106
SFR.4/VS	SF910	50	99
SFR.4/VS/GR	SF910GR	50	106
SFR.4/VS/GR	SF910GR	50	99
SFR.6	SR300	50	107
SFR.6	SR300	50	98
SFR.6 [EX]I	SR400	50	107
SFR.6 [EX]I	SR400	50	98
SFR.6/GR	SR300GR	50	98
SFR.6/GR	SR300GR	50	107
SFR.6/M	SR500	50	107
SFR.6/M	SR500	50	98
SFR.6/M [EX]I	SR600	50	98
SFR.6/M [EX]I	SR600	50	107
SFR.6/M/GR	SR500GR	50	98

T

TYPE	CODE	QTY. per pk.	PAGE
SFR.6/M/GR	SR500GR	50	107
SFR.6/PT	SR301	25	148
SFR.6/PT[Ex]i	SR401	25	148
SFR/PT	SF701	25	148
SFR/PT [Ex]i	SF801	25	148
SH004SP	SH004SP	500	185
SH2.1	SH004S	1500	185
SH4/PT	DH401	25	165
SH5/PT	DH501	25	165
SH6/PT	DH601	25	165
SH7/PT	DH701	25	165
SNZ/4/00	SN008	60	185
SNZ/4/SP	SN004SP	60	185
TC/PO	TC500	125	127
TC/PO [EX]I	TC510	125	127
TC/PO/GR	TC500GR	125	127
TDE.2	TL500	125	96
TDE.2/GR	TL500GR	125	96
TE.10/D	TE500	35	89
TE.10/O	TO500	35	87
TE.16/D	TE210	30	89
TE.16/O	TO210	30	88
TE.50/D	TE310	15	89
TE.50/O	TO310	15	88
TE.6/D	TE110	50	88
TE.6/O	TO110	45	87
TEC.10/O	TO510	35	62
TEC.16/O	TO220	30	62
TEC.35/O	TO320	15	63
TEC.6/O	TO120	45	62
TEC.70/O	TO810	25	63
TED.4	TE400	65	87
TEO.2	TO910	75	86
TEO.2/PT	TO901	50	148
TEO.4	TO430	50	86
TEO.4/PT	TO431	25	148
TH/2	TH02	50	174
TH/3	TH03	50	174
TLD.2	TL200	125	96
TLD.2 [EX]I	TL300	125	96
TLD.2/GR	TL200GR	125	96
TLD/PT	TL201	25	148
TLD/PT [Ex]i	TL301	25	148
TLE.2	TL400	200	96
TLE.2/GR	TL400GR	200	96
TLS.2	TL100	200	95
TLS.2/GR	TL100GR	200	95
TLS/PT	TL101	25	148

INDEX BY TYPE



TYPE	CODE	QTY. per pk.	PAGE
TLS/PT/GR	TL201GR	25	148
TPL.4	TP100	40	131
TPL.4/PS	TP200	40	132
TR.2	TR110	100	130
TR.2/PT	TR111	25	148
TR.4	TR200	50	130
TTM/04	TTM04	10	173
TTM/12	TTM12	10	173
TTM/15	TTM15	10	173
TUM/05	TUM05	10	173
TUM/06	TUM06	10	173
TUM/06	TUM06	10	173
TUM/07	TUM07	10	173
TUM/08	TUM08	10	173
TUM/16	TUM16	10	173
VPC.2 (EX)I	VP310	120	125
VPC.2/GR	VP300GR	120	125
VPC/PT	VP101	25	148
VPC/PT (Ex)i	VP201	25	148
VPC/PT/GR	VP101GR	25	148
VPD.2 (EX)I	VP560	40	126
VPD.2/GR	VP500GR	40	126
VPD/PT(Ex)i	VP561	25	148
VPD/PT/GR	VP501GR	25	148
WP1-14	WP30009	500	176
WP1-18	WP30010	500	176
WP100-21	WP30024	100	176
WP100-28	WP30025	500	176
WP15-14	WP30013	500	176
WP15-18	WP30014	500	176
WP160-22	WP30026	100	176
WP160-28	WP30027	500	176
WP25-14	WP30016	500	176
WP25-19	WP30017	500	176
WP250-29	WP30028	50	176
WP250-32	WP30029	500	176
WP350-30	WP30030	50	176
WP350-41	WP30031	500	176
WP40-16	WP30019	500	176
WP40-20	WP30020	500	176
WP5-14	WP30002	500	176
WP5-16	WP30003	500	176
WP500-40	WP30032	50	176
WP500-41	WP30033	500	176
WP60-20	WP30022	100	176
WP60-26	WP30023	500	176
WP75-14	WP30005	500	176
WP75-16	WP30006	500	176

TYPE	CODE	QTY. per pk.	PAGE
WPD01/15	WP90003	500	177
WPD04/23	WP90006	500	177
WPD05/15	WP90001	500	177
WPD15/16	WP90004	500	177
WPD25/18	WP90005	500	177
WPD75/15	WP90002	500	177
WPN0508	WPN10508	1000	177
WPN0758	WPN10758	1000	177
WPN1010	WPN11010	1000	177
WPN1015	WPN11015	500	177
WPN1510	WPN11510	1000	177
WPN1615	WPN11615	1000	177
WPN2510	WPN12510	1000	177
WPN2515	WPN12515	250	177
WPN4012	WPN14012	1000	177
WPN6012	WPN16012	500	177

Blank lined area for notes.



AUTOMATION
AND CONTROL
SOLUTIONS



INDUSTRIAL
CONNECTIVITY
SOLUTIONS

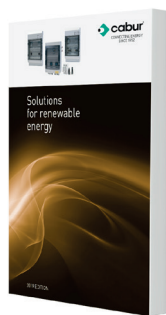

SOLUTIONS
FOR RENEWABLE
ENERGY



INDUSTRIAL
MARKING
SOLUTIONS



D011G19A - 0619

Cabur Srl

Headquarters (Italia)

17041 - Altare (SV)

Località Isola Grande, 45

T. +39 019 58999.1

F. +39 019 58999233

www.cabur.it

info@cabur.it

Cabur Romania Srl

Romanian Branch

Strada Calea Plevnei nr. 139

Corp B camera 25,26 sector 6

Bucaresti

T. +40 (21)31.17.140

F. +40 (21)31.17.140

www.cabur.eu

alexandru.cazacu@cabur.eu