

## Single Phase Power Calibrator and Tester of Power Engineering Devices

### Calmet CP11B

- Voltage source up to 560V
- Current source up to 120A with a single pair of current sockets
- Accuracy class 0.02% or 0.05% to calibrate digital instruments
- Single product in a single case without auxiliary amplifiers
- High burden of outputs to drive older analogue instruments
- Large color Touchscreen and Calpro 300 PCsoft
- Manual mode and automatic test procedures



The CP11B Calibrator and Tester is used for calibration and testing a wide range of measuring instruments used in power engineering and enables testing:



**AC voltmeters, AC ammeters, frequency meters, phase angle meters, power factor meters, wattmeters, VARmeters, VAmeters, clamps meters** and much more,



**power quality analysers, recorders and flickermeters** IEC 61000-4-30 class A for EN 50160 compatibility or individual requirements of user.

The CP11B enables automatic testing with calculating of errors and standard deviation:



**electricity meters** EN 50470 with accuracy relative to an internal reference of the CP11B (or relative to an external reference meter) including: measure the basic error and influence of frequency, voltage, self-heating, distortion,..., checking the starting current and no-load run,



**electrical measuring transducers for converting a.c. electrical quantities** EN 60688 (voltage, current, active power, reactive power, frequency, phase angle, power factor),



**current instrument transformers** EN 60044 including measure the accuracy of current and phase angle as well as burden measurement,



**current clamps** with AC & DC voltage and current output including measure the accuracy of current and phase angle,



**protective relays** EN 60255 including checking of tripping time and tripping level characteristics of ANSI#21 Distance relays, ANSI#27/59 Under/over voltage relays, ANSI#32 Directional power relays, ANSI#50/51 Time overcurrent relays, ANSI#81 Frequency relays and more protective relays.

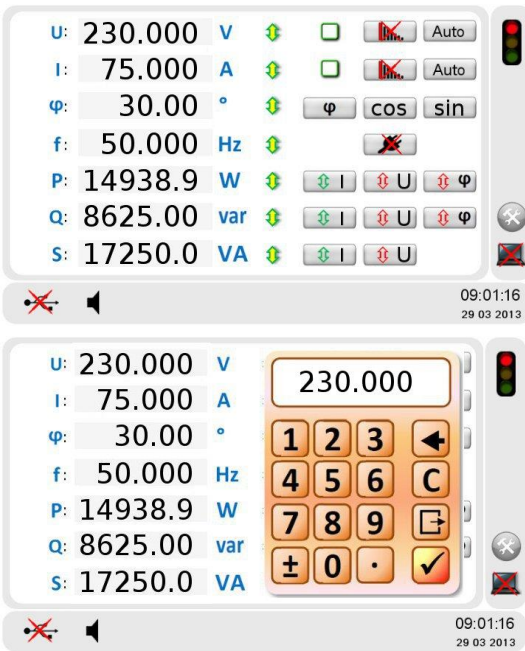

Intuitive front panel design with large Touchscreen display and ergonomic keyboard for ease of use enables:

- setting the value of voltage U, current I, phase angle  $\phi$  or power factor cos/sin, frequency f and powers P, Q, S (by changing I, U or  $\phi$ ) with using numeric keyboard or  $\uparrow/\downarrow$  keys to decrease or increase setting with different speed,
- selecting of voltage and current constant range and autorange mode,
- switching ON/OFF waveform distortion of voltage and current,
- switching Operate/Standby state of calibrator's output.

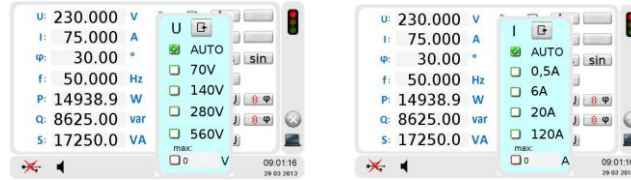

**Specification for the sinusoidal signals**

Parameter	Range	Settings span	Resolution	Uncertainty <sup>1)</sup>		Maximum load
				class 0.02	class 0.05	
Voltage U	70V	0.5000...70.0000V	0.0001V	±0.02% <sup>2)4)</sup>	±0.05% <sup>2)4)</sup>	560mA@70V
	140V	1.000...140.000V	0.001V			280mA@140V
	280V	2.000...280.000V	0.001V			140mA@280V
	560V	5.000...560.000V	0.001V			70mA@560V
Voltage short term [1h] stability				±0.005% <sup>2)</sup>	±0.010% <sup>2)</sup>	
Voltage long term [1year] stability				±0.01% <sup>2)</sup>	±0.02% <sup>2)</sup>	
Voltage temperature drift per 1°C				±0.0005% <sup>2)</sup>	±0.0010% <sup>2)</sup>	
Current I	0.5A	0.001000...0.500000A	0.000001A	±0.02% <sup>2)5)</sup>	±0.05% <sup>2)5)</sup>	17V@0.5A
	6A	0.05000...6.00000A	0.00001A			8.5V@6A
	20A	0.2000...20.0000A	0.0001A			3.3V@20A
	120A	1.000...120.000A	0.001A			0.95V@60A <sup>7)</sup> 0.70V@120A <sup>7)</sup>
Current short term [1h] stability				±0.005% <sup>2)</sup>	±0.010% <sup>2)</sup>	
Current long term [1year] stability				±0.01% <sup>2)</sup>	±0.02% <sup>2)</sup>	
Current temperature drift per 1°C				±0.0005% <sup>2)</sup>	±0.0010% <sup>2)</sup>	
Frequency f		40.000...500.000Hz	0.001Hz	±0.005%		
Phase shift $\phi$		0.00...±360.00°	0.01°	±0.05° <sup>2)</sup>	±0.10° <sup>2)</sup>	
Active power P		0...3x67200.0W	0.00001-1W	±0.02% <sup>2)3)</sup>	±0.05% <sup>2)3)</sup>	
Reactive power Q		0...3x67200.0var	0.00001-1var	±0.02% <sup>2)3)</sup>	±0.05% <sup>2)3)</sup>	
Apparent power S		0...3x67200.0VA	0.00001-1VA	±0.02% <sup>2)</sup>	±0.05% <sup>2)</sup>	
Power short term [1h] stability				±0.005% <sup>2)8)</sup>	±0.010% <sup>2)8)</sup>	
Power long term [1year] stability				±0.01% <sup>2)8)</sup>	±0.02% <sup>2)8)</sup>	
Power temperature drift per 1°C				±0.0005% <sup>2)</sup>	±0.0010% <sup>2)</sup>	
Time <sup>6)</sup>		1...36000s	1s	±0.01% ±0.001s		
Energy	calculated from settings of power and time			±0.02% <sup>2)3)</sup>	±0.05% <sup>2)3)</sup>	

<sup>1)</sup> absolute extended uncertainty under confidence level of 95% covers reference uncertainty of standards, stability in 12 months, influence quantities (ambient temperature in range +20...+26°C, humidity and power supply voltage according to the table 2.3, load acc. to table 2.1, frequency in range 45...65Hz) and nonlinearity. For frequency band below 45Hz and above 65Hz – linear rise up typically to double value for frequency 40Hz and 500Hz  
<sup>2)</sup> of setting value, for settings from 10% of current range and 30% of voltage range  
<sup>3)</sup> uncertainty of power P(Q) under  $\cos\phi(\sin\phi)=1$ , for  $\cos\phi(\sin\phi)\neq 1$  linear rise up to 0.15% (class 0.02) or 0.30% (class 0.05) for  $\cos\phi(\sin\phi)=0.5$   
<sup>4)</sup> for voltage below 30% of range uncertainty 0.006% of range (class 0.02) or 0.015% of range (class 0.05)  
<sup>5)</sup> for current below 10% of range uncertainty 0.002% of range (class 0.02) or 0.005% of range (class 0.05)  
<sup>6)</sup> for energy dosage  
<sup>7)</sup> 0.85V@60A and 0.50V@120A using the AKD300 current cables length 1m  
<sup>8)</sup> stability of power S and P(Q) under  $\cos\phi(\sin\phi)=1$ , for  $\cos\phi(\sin\phi)\neq 1$  linear rise up to 0.04% for  $\cos\phi(\sin\phi)=0.5$

**General parameters**

Weight	14kg
Width x height (with feet) x depth (with feet and handle)	(448x181x431)mm
Power supply	90V...264V / 47...63Hz / 300VA

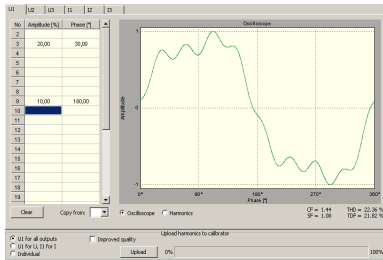

PQ (Power Quality) function enables generation of nonsinusoidal voltage and current waveforms with harmonics, interharmonics and subharmonics as well as simulation of voltage, current, phase shift and frequency variations as a function of time (dips, interruptions, swells, flicker, fluctuations and ramp signals).

PQ functions meet all accuracy requirements of power quality testing to the EN 61000-4 series of standards.

**Harmonics**

Harmonics are voltages and currents with a frequency, that is an integral multiple of the fundamental frequency. Harmonic testing is defined in EN 61000-4-7 and EN 61000-4-13.

The CP11B can generate multi-harmonic distortion with independent superposition of harmonic components of current and voltage, with levels 0...100% and phase angle 0...360° of the first harmonic.

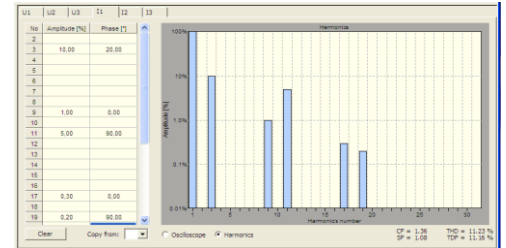

**Interharmonics**

Interharmonics are voltages with a frequency, that is a non-integral multiple of the fundamental frequency. For example, in 50Hz supply system, 150Hz is a harmonic (the third) but 175Hz is an interharmonic. Interharmonic testing is defined in EN 61000-4-7 and EN 61000-4-13.

The CP11B can generate interharmonics at a user-definable frequency up to 3200Hz, amplitude and phase angle.

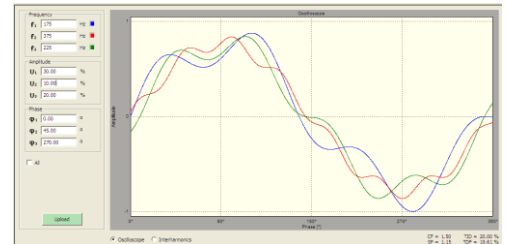

**Dips, Interruptions, Swells and Shocs**

Dips are a temporary reduction of the voltage below nominal (Interruptions below 1% nominal) and Swells are a temporary increase of the voltage above nominal up to 200% nominal for a time from 10ms up to several minutes. Shocs (Inrush current) are a temporary increase of the current above nominal when first turned on of an electrical device. Dips, Interruptions and Swells testing are defined in EN 61000-4-11 and EN 61000-4-34.

The CP11B can generate a user-definable fast and slow changes of voltage and current independently.

CP11B output signals recorded by digital oscilloscope

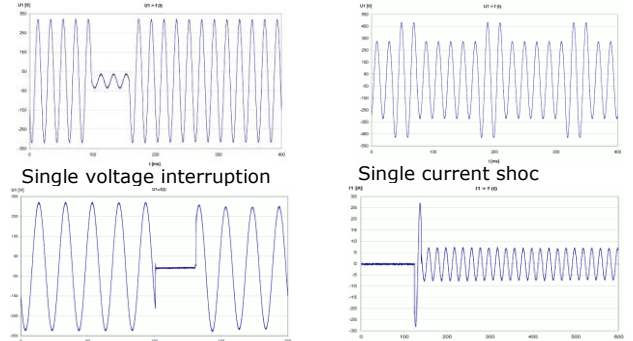

**Flicker**

Flicker is a specific measurement, which sets out to measure the human sensitivity of a flickering light caused by supply voltage fluctuation around of a nominal value. Flickermeter testing is defined in EN 61000-4-15.

The CP11B generates voltage changes for performance testing and displays the results in P<sub>st</sub> / P<sub>it</sub> severity including combined frequency/voltage changes, harmonic/interharmonic distortion and phase jumps.

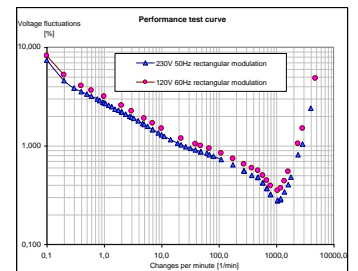

Specification for the nonsinusoidal and time-varying signals						
Parameter		Settings span	Resolution	Uncertainty <sup>1)</sup>		Conditions
				class 0.02	class 0.05	
Harmonics	magnitude	0...100% output value	0.01%	±0.02% <sup>2)</sup>		up to 64th or 3200Hz
	phase	0...360°	0.01°	±0.5° <sup>2)</sup>		
Interharmonics in voltage		0...30% output value	0.01%	±0.2% <sup>3)</sup>		for 16...9000Hz
Dips	magnitude	0...100% nominal value	6 digits	±0.05% <sup>4)</sup>		
	duration	0.02...999s	0.001s	0.001s		
Swells	magnitude	0...200% nominal value	6 digits	±0.05% <sup>4)</sup>		
	duration	0.02...999s	0.001s	0.001s		
Flicker	P <sub>st</sub>	0...40	0.00001	±1%		acc. IEC61000-4-15
	modulation	0.1...4000 changes/min or 0.000833...33.33Hz	7 digits or 4 digits			
	duration	1s...999h	1s			

<sup>1)</sup> absolute extended uncertainty under confidence level of 95% covers reference uncertainty of standards, stability in 12 months, for 45-65Hz  
<sup>2)</sup> 0,02% of output value and 0,5° for frequency range of harmonics 80-120Hz with linear rise up to 0.2% of output value and 4° for 3200Hz  
<sup>3)</sup> 0,2% of output value for frequency range of interharmonics 16-120Hz with linear rise up to 2% of output value for 9000Hz  
<sup>4)</sup> with uncertainty of voltage and current for calibrator class 0.05 in setting span of voltage and current

Automatic test system

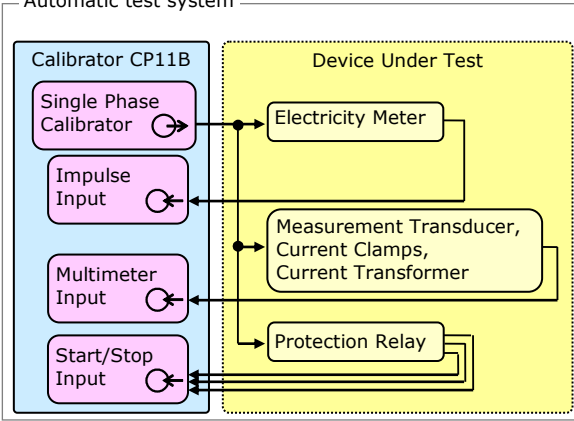

Test System function for testing of electricity meters, measurement of industrial transducers, current clamps, current transformers and protection relays in fully automatic way under sinusoidal and nonsinusoidal conditions, for example the CP11B can be used to type test from 0.1% to 2% energy meters acc. to EN 50470.

Current output provides currents in full current range from 1mA up to 120A through compact banana sockets without needed to manual switch current terminals during test.

Parameters of Inputs and Outputs for automatic tests functions

Input / output	Range	Uncertainty <sup>1)</sup>	Number of inputs/outputs	Conditions	
Impulse Input for counting pulses from electricity meter, photo scanning head or reference meter	range of input voltage 0...2V/4...30V	0.001% @ $t \geq 1s$	2	frequency range <sup>3)</sup> 0.000001Hz...200kHz max test time 1193[h]/f[kHz]	
Multimeter Input	DC Voltage	0...±14.0000V	1	in 45...65Hz range	
	DC Current	0... ±24.0000mA			
	AC Voltage	0...10.0000V			
	AC Current	0...16.0000mA			0.05% + 1.6µA
		0...200.000mA			0.05% + 10µA
Phase shift	0...360.00° ref. to I1	0.1° <sup>2)</sup>			
Start/Stop Input for time measurement	0.001...100.000s	0.001s	3	range of input voltage 15...250V DC/AC	
Binary Output of Operate/Standby for signalling state of Calibrator		time of state change 0.001s	2	output load 250VDC/0.5A/10VA	
Impulse Output for CP11B testing	0.0001Hz...210kHz	0.000...0.009% <sup>4)</sup>	1	open collector 28V/100mA	

<sup>1)</sup> absolute extended uncertainty under confidence level of 95% including stability in 12 months

<sup>2)</sup> from 5% of current and voltage range

<sup>3)</sup> fmax=120kHz for both inputs simultaneously

<sup>4)</sup>  $0.003\% + 0.006\%/t[s]$  for  $f \geq 2Hz$  and  $0.003\% \times \sqrt{f[Hz]}$  for  $f < 2Hz$ , where t is test time and f is output frequency

Examples of the Calmet CP11B applications

Electricity meter testing with accuracy referenced to an internal reference of the CP11B

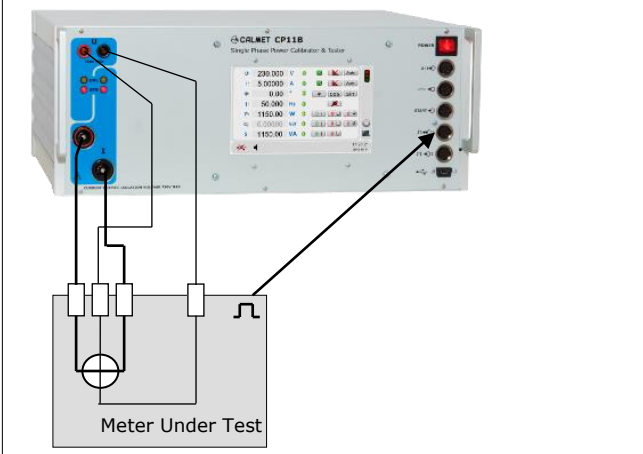

Electricity meter testing with accuracy referenced to an external reference meter

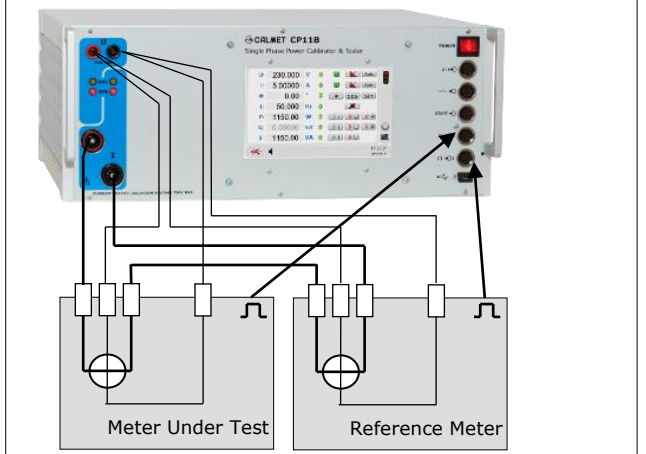

**Calpro 300 PC software features:**

- using a modern concept, which allows the operator to create own test procedures - this is very important because new requirements for new meter generations can be realized easily without changing the complete software,
- the automated mode - direct execution of the complete test procedure automatically and requires no more additional handling by operator unless it will not be defined in the test procedure,
- the manual mode - direct execution of single test step. It offers an ideal solution for tests and evaluation of entire specifications for devices under test without generating the complete test procedure,
- computer database of customers, devices, measurement procedures and results, diagrams, tables of results and reports edition,
- traditional manual settings the value of all parameters of output signals.

**Advantages of Calpro 300 PC soft:**

- user-friendly operation,
- database for devices and test procedures,
- fully-automatic test procedures,
- continuous monitoring of the test,
- tables and graphics for presentation of results,
- operator interface available in several languages,
- automatic measurements report generation.

**Versions of Calpro 300 PC software:**

**Calpro 300 Basic PC software** version enables traditional manual setting:

- the value of  $U+I+\phi+f+P+Q+S$ ,
- the wave shape of voltage and current with using harmonics, interharmonics and shape function.

**Calpro 300 PQ Power Quality PC software** version enables generating sinusoidal and nonsinusoidal voltage and current, which value is changed in time for testing meters, recorders and power quality analyzers with the following functions:

- *Slow Ramp* for generate voltage and current which value is changed relative slow to the time,
- *Fast Ramp* for generate voltage and current which value is changed relative fast to the time,
- *Flicker* for generate voltage fluctuation (Flicker) levels expressed in Plt and Pst coefficients.

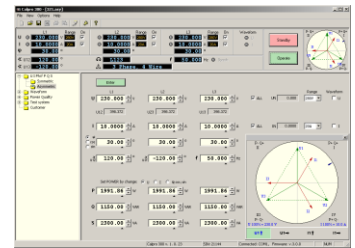

**Calpro 300 TS Test System PC software** version enables using a modern concept, which allows the operator to create own test procedures with using automated / manual mode for automatic testing the following devices:

- liczników energii,
- current clamps,
- current transformers,
- measurement transducers,

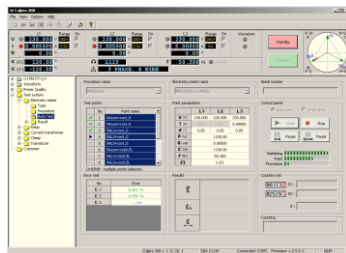

- protection relays (*Quick* function for quick relay's testing, *Trigger Time* function for tripping time testing and *Trigger Level* function for tripping level testing),

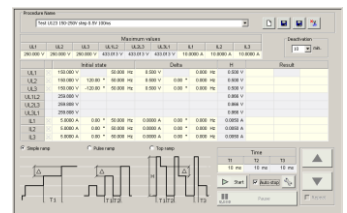

**Calpro 300 Basic + TS** and **Calpro 300 Basic + PQ** have the following functions:

- *Type* for entering data to testing devices database,
- *Procedure* for entering data to measuring procedures database,

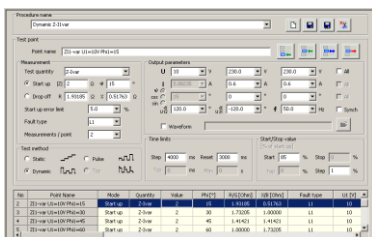

- *Result* for visualization, edition and storing measurements results in form of tables and diagrams, easy Report generation, printing and exporting data to MS Excel,

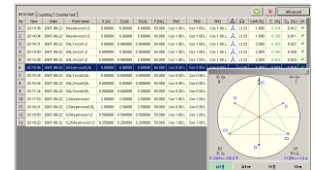

- *Auto Test* for performing automatic test of device,

- *Client* function for collecting data in clients database and *Admin* function for using clients database during reports edition.

## The Calmet CP11B Calibrator's set and applications

Current clamps testing with using the CP11B Calibrator, Calmet ZW10/20A coil and Calmet AD300 sockets adapter

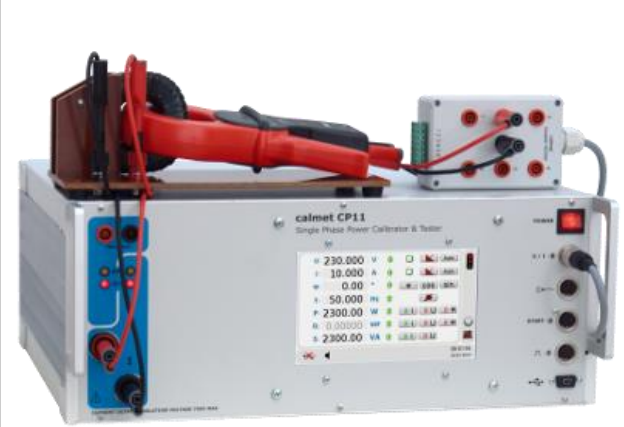

Electricity meter testing with using the TB10 single phase fully automated 0.02 (0.05) accuracy class test station, consisting of the Calmet CP11B Calibrator, ER10 rack, EH10.1 quick connection device, CF106H photo head and EA11 cables

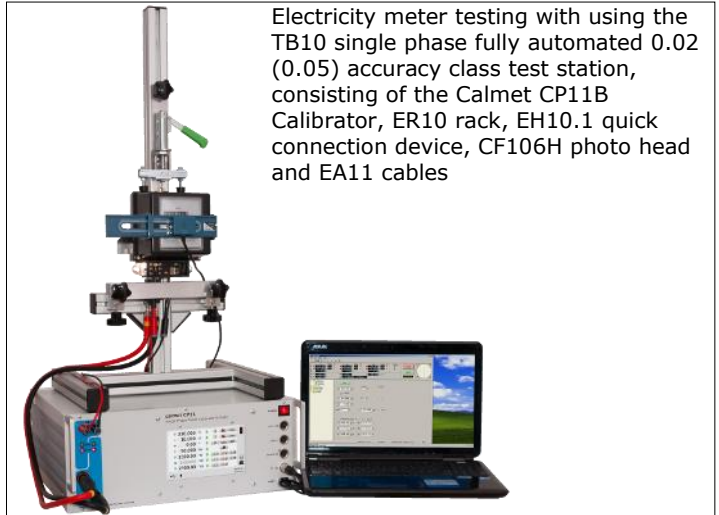









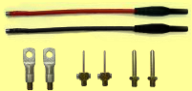
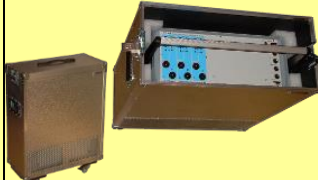

### Calmet CP11B Calibrator's equipment

#### All completed Calmet CP11B Calibrator's set consists of:

- Calmet CP11B calibrator case class 0.02 or 0.05,
- power cord,
- Calpro 300 Soft – Basic Version,
- USB mini / USB A interface cable,
- fuse T2A, 250V, 5x20 (2units),
- set of safety voltage cables (2units),
- set of safety current cables up to 20A (2units),
- set of accessories for safety cables (4units banana plug +4units Cu),
- AD300 sockets adapter,
- C091A T3475-001 plug Amphenol for Calibrator inputs,
- operation manual of calibrator and software (2units),
- warranty card,
- calibration certificate.

#### Optionally for Calmet CP11B Calibrator are available:

<ul style="list-style-type: none"> <li>• Calpro 300PQ PC Soft for Power Quality measurement devices testing,</li> </ul>		<ul style="list-style-type: none"> <li>• Laptop,</li> </ul>	
<ul style="list-style-type: none"> <li>• Calpro 300TS PC Soft for automatic test of electric equipment,</li> </ul>		<ul style="list-style-type: none"> <li>• Calmet C300 LabView-LabView Driver for CP11B Calibrator,</li> </ul>	
<ul style="list-style-type: none"> <li>• EA11 current cables up to 120A (2units) with set (6units) of replaceable terminals,</li> </ul>		<ul style="list-style-type: none"> <li>• ET11 transportation case for portable work,</li> </ul>	
<ul style="list-style-type: none"> <li>• CF106H photo head with holder for inductive meter and meter with LED,</li> </ul>		<ul style="list-style-type: none"> <li>• MPX8 Eight Inputs Multiplexer with MPX8 PC Soft for simultaneously testing up to eight electricity meters,</li> </ul>	
<ul style="list-style-type: none"> <li>• ER10 rack for hanging of meter under test,</li> </ul>		<ul style="list-style-type: none"> <li>• ER10+EH10 (ER10H) - rack for hanging of meter under test with quick connection device</li> </ul>	
<ul style="list-style-type: none"> <li>• ZW100/10A coil 100 turns / 10A,</li> </ul>		<ul style="list-style-type: none"> <li>• ZW10/20A coil 10 turns / 20A</li> </ul>	

Calmet Ltd

Kukulcza 18, 65-472 Zielona Gora, Poland

Phone +48 68 324 04 56 Fax +48 68 324 04 57

E-mail: mail@calmet.com.pl Web access: <http://www.calmet.com.pl>